



# SHEPPARD

*Quality Engineered Products. Unlimited Capabilities.*



## M-Series Power Steering Service Manual

*“We provide personal customer support through training and education programs, a telephone hotline and technical field assistance, as well as one of the best warranty programs in the business.”*

*Peter H. Sheppard  
President*



Part# 7000400

## Index

SECTION	DESCRIPTION	PAGE
I	SAFETY NOTICE.....	2
	Introduction .....	3
	Oil Flow .....	5
	Gear Identification .....	6
	Exploded View of Steering Gear .....	7
	Service Parts Kits/Lubrication.....	8
II	DIAGNOSIS & TROUBLESHOOTING .....	9
	Glossary.....	14
	Troubleshooting Guide .....	15-18
III	COMMON PROCEDURES .....	19
	Preventive Maintenance.....	20
	Input Shaft Seal Replacement .....	22
	Sector Shaft Seal Replacement .....	30
	Bleeding Single Gear .....	28
	Bleeding Dual Steering Gears .....	29
	Axle Stop Adjustment.....	32
	Alternate Bleed Procedure .....	33
	Set Relief Plungers Manual Plungers Adjustment .....	42
	Set Automatic Relief Plungers .....	35
	Adjust Automatic Relief Plungers.....	36
	Repair Automatic Relief Plungers .....	37
	Pitman Arm Removal .....	41
	Pitman Arm Installation .....	43
Input Shaft Seal Replacement (M-110P2).....	45	
IV	DISASSEMBLY.....	49
VI	REASSEMBLY .....	55
VII	DUAL STEERING SYSTEMS .....	61
VIII	FINAL ADJUSTMENTS.....	65
IX	MISCELLANEOUS.....	66
	Troubleshooting Checklist .....	66
	Order Sheet - Heavy Duty Power Steering Test Kit .....	67

## SAFETY NOTICE

 **STOP!** Before you begin, please read this manual carefully. The repair procedures outlined in this manual are for repairing the Sheppard Integral Power Steering Gear. To ensure safe and reliable operation, these service and repair procedures must be followed carefully.

### **WARNING**

THIS MANUAL CONTAINS A NUMBER OF SAFETY SIGNAL WORDS LIKE: DANGER, WARNING, CAUTION, IMPORTANT, or NOTE. The information following a safety signal word is very important.

When you see the word  **DANGER** it means the information will help you avoid an extreme hazard that could kill or cause a very serious injury every time.

When you see the word  **WARNING** it means there is a hazard that is not as serious as DANGER but the hazard could cause injury or death if you do not follow the proper rules or procedures.

When you see the  **CAUTION** it means the information that follows will help avoid damage to the steering gear.

The signal words IMPORTANT or NOTE are used to draw attention to ways of doing your job better or right.

## INTRODUCTION

This service manual covers repair procedures for the Sheppard steering gear assembly only. The Vehicle Manufacturer's Service Manual should be used for removal and reinstallation instructions, and hydraulic supply pump specifications.

Any reference made to a brand name, special tools or item part number are made as a guide.

All information, illustrations and specifications in this manual are the latest available at the time of printing. We reserve the right to make changes without notice. If you are not certain you have the current revision of this manual or if you have questions about procedures, please call our Field Service Department at 717-633-4111 before you begin repairs.

## OPERATING PRINCIPLES

The Sheppard M-Series Integral Power Steering Gear provides full-time hydraulic steering. Only enough manual effort to overcome the torsion bar and turn the rotary valve is required.

The actuating shaft (1) is connected to the steering column and is centered within the rotary valve by a torsion bar. The rotary valve shaft is threaded into the piston with ball threads (2) and travels within the piston on steel balls. Rotating the input shaft causes high pressure fluid to build up on one end of the piston. This higher pressure causes the piston to move in the bore of the gear housing. The sector shaft (3) is engaged to a rack gear (4) machined into one side of the piston. Piston rack movement causes sector shaft and pitman arm rotation. When steering shaft rotation stops, the actuating valve returns to its neutral position. Relief valve plungers or adjustable stops are used in the bearing cap and cylinder head. When the plungers are adjusted properly, they will unload the hydraulic system if the wheels are in a full turn to either direction.

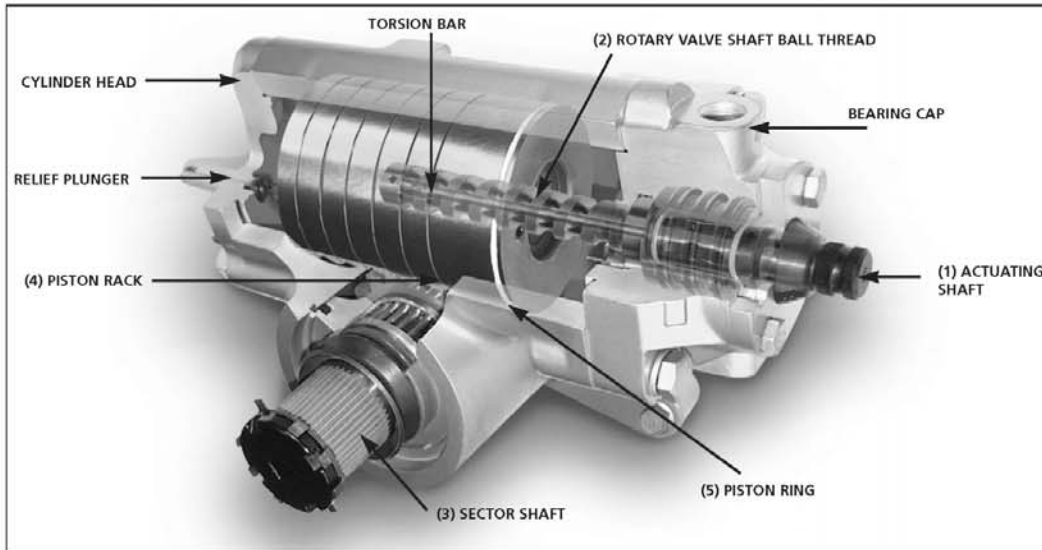

When the engine is running there is constant low pressure oil flow through the steering gear. This constant oil flow provides an instant response and absorbs road shock to help eliminate steering wheel kick. Pressure is equal throughout the steering gear; however, care should be used when towing or moving a vehicle where the engine or hydraulic supply pump is not running.

**NOTE:** If sudden loss of pressure occurs during normal driving, the parts are designed to provide mechanical back-up steering so that the vehicle may be safely steered to the side of the road.

An optional integral pressure relief valve is available on the M-Series Steering Gears. This valve limits maximum steering system relief pressure at the steering gear. This reduces system temperature by avoiding high pressure by-pass and recirculation within the pump.

The Sheppard Integral Power Steering Gears have been designed to provide long service life and simple service repair. The rack and sector shaft does not require center point adjustment. The clearance between the cylinder bore and the piston is closely controlled, and a piston ring (5) was added to better use the hydraulic oil supplied.

With reasonable care and limited maintenance the Sheppard M-Series Steering Gear will provide many miles of reliable performance.

**OIL FLOW THROUGH THE M-SERIES GEAR**

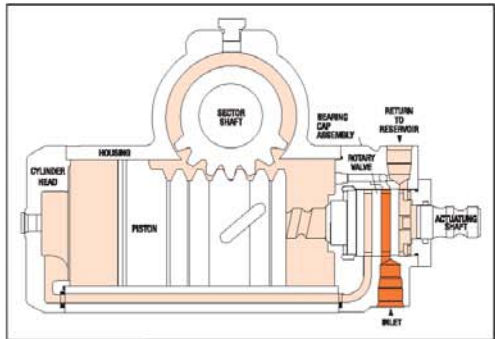

Figure 1

**Figure 1**

Here we see the steering gear in the neutral or non steering position. Equal low pressure is being applied to both ends of the steering gear piston. The oil is circulating at back pressure only and provides a hydraulic cushion for the steering gear. All oil is being circulated through the steering gear and back to the reservoir to help cool the system.

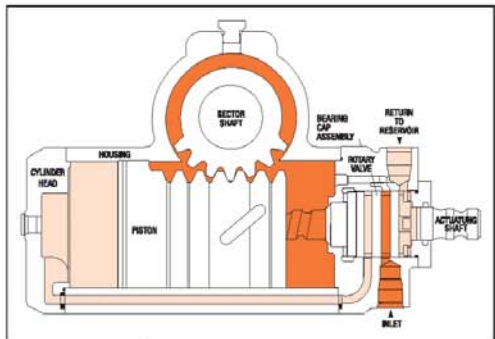

Figure 2

**Figure 2**

When the steering wheel is turned, the actuating valve is opened in one direction, all pressurized oil is applied to one end of the steering gear piston. This pressure build up causes the piston to move in the steering gear.

Figure shows all oil being distributed to the input end of the gear.

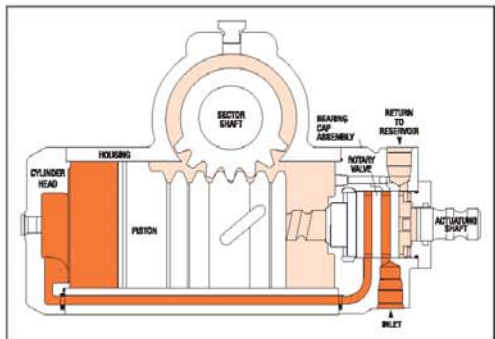

Figure 3

**Figure 3**

Figure shows all oil being distributed to the cylinder head end of the gear.

When no input is applied through the steering wheel the gear returns to the neutral or non steering position.

**STEERING GEAR IDENTIFICATION**



A number is cast into the steering gear housing and identifies the basic family the steering gear belongs to.

Stamped letters and numbers on an exposed machined surface of the housing (opposite the mounting side) identifies the gear specification; see gear P/N chart below. In the above example the complete identification is Model M-100PAD1A1. Cast number M-100 would refer to the M-Series steering gear family.

**GEAR P/N CHART**

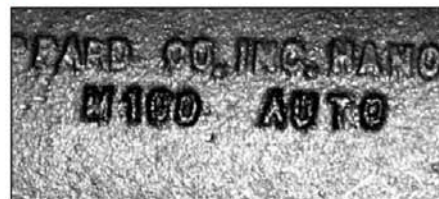
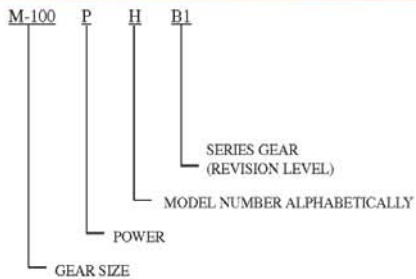

A serial number is also assigned to each steering gear and is interpreted below:

**SERIAL NUMBER SYSTEM**

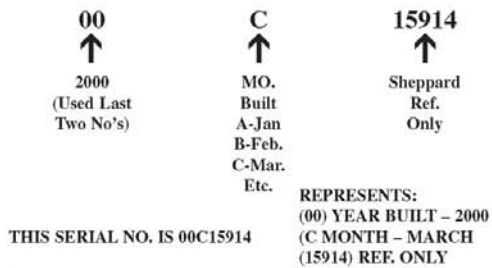

**SERVICE PARTS LIST**

- ① HOUSING (NOT SOLD SEPARATELY)
- ② CYLINDER HEAD (NOT SOLD SEPARATELY)
- ③ BEARING CAP/SHAFT ASSEMBLY
- ④ SECTOR SHAFT COVER (NOT SOLD SEPARATELY)
- ⑤ SECTOR SHAFT
- ⑥ PISTON ASSEMBLY (NOT SOLD SEPARATELY)
- ⑦ PRESSURE RELIEF CARTRIDGE
- ⑧ PITMAN ARM RETAINER
- ⑨ PITMAN ARM (SOLD BY APPLICATION)
- ⑩ INPUT SHAFT SEAL KIT
- ⑪ SECTOR SHAFT SEAL KIT
- ⑫ CYLINDER HEAD PLUNGER KIT
- ⑬ BEARING CAP PLUNGER KIT
- ⑭ BLEEDER PLUG KIT

# M-SERIES P1

R. M. SHEPPARD CO., INC.		7548043	
SPL-75			
REV. 10/11			
REV. 09/10			
REV. 08/09			
REV. 07/08			
REV. 06/07			
REV. 05/06			
REV. 04/05			
REV. 03/04			
REV. 02/03			
REV. 01/02			
REV. 00/01			
REV. 99/00			
REV. 98/99			
REV. 97/98			
REV. 96/97			
REV. 95/96			
REV. 94/95			
REV. 93/94			
REV. 92/93			
REV. 91/92			
REV. 90/91			
REV. 89/90			
REV. 88/89			
REV. 87/88			
REV. 86/87			
REV. 85/86			
REV. 84/85			
REV. 83/84			
REV. 82/83			
REV. 81/82			
REV. 80/81			
REV. 79/80			
REV. 78/79			
REV. 77/78			
REV. 76/77			
REV. 75/76			
REV. 74/75			
REV. 73/74			
REV. 72/73			
REV. 71/72			
REV. 70/71			
REV. 69/70			
REV. 68/69			
REV. 67/68			
REV. 66/67			
REV. 65/66			
REV. 64/65			
REV. 63/64			
REV. 62/63			
REV. 61/62			
REV. 60/61			
REV. 59/60			
REV. 58/59			
REV. 57/58			
REV. 56/57			
REV. 55/56			
REV. 54/55			
REV. 53/54			
REV. 52/53			
REV. 51/52			
REV. 50/51			
REV. 49/50			
REV. 48/49			
REV. 47/48			
REV. 46/47			
REV. 45/46			
REV. 44/45			
REV. 43/44			
REV. 42/43			
REV. 41/42			
REV. 40/41			
REV. 39/40			
REV. 38/39			
REV. 37/38			
REV. 36/37			
REV. 35/36			
REV. 34/35			
REV. 33/34			
REV. 32/33			
REV. 31/32			
REV. 30/31			
REV. 29/30			
REV. 28/29			
REV. 27/28			
REV. 26/27			
REV. 25/26			
REV. 24/25			
REV. 23/24			
REV. 22/23			
REV. 21/22			
REV. 20/21			
REV. 19/20			
REV. 18/19			
REV. 17/18			
REV. 16/17			
REV. 15/16			
REV. 14/15			
REV. 13/14			
REV. 12/13			
REV. 11/12			
REV. 10/11			
REV. 09/10			
REV. 08/09			
REV. 07/08			
REV. 06/07			
REV. 05/06			
REV. 04/05			
REV. 03/04			
REV. 02/03			
REV. 01/02			
REV. 00/01			

20-10000-12



**SEAL KITS**

**M100 COMPLETE SEAL KITS:**

Sheppard Part No. 5543211	Complete seal kit for all M100 steering gears with push-on dust boot on sector shaft
Sheppard Part No. 5542331	Complete seal kit for all M100 steering gears with a pressed-in excluder seal on the sector shaft
Sheppard Part No. 5543481	Complete seal kit for all M100 steering gears with a snap-ring cover and a push-on dust boot at the sector shaft
Sheppard Part No. 5543491	Complete seal kit for all M100 steering gears with a snap ring cover and a pressed-in excluder seal on the sector shaft

**M90 COMPLETE SEAL KIT**

Sheppard Part No.	5543551 Complete seal kit for all M90 steering gears
-------------------	--

**M80 COMPLETE SEAL KITS:**

Sheppard Part No. 5543461	Complete seal kit for all M80 steering gears
---------------------------	--

**M110 COMPLETE SEAL KITS:**

Sheppard Part No. 5541411	Complete seal kit for all M110P2 steering gears
Sheppard Part No. 5542621	Complete seal kit for all M110P1 steering gears

**M-SERIES INPUT SHAFT SEAL KITS:**

Sheppard Part No. 5542261	Input shaft seals for all M-Series gears built from June 1991 to present
Sheppard Part No. 5541351B	Input shaft seals for all M-Series gears built prior to June 1991

**M100 SECTOR SHAFT SEAL KITS:**

Sheppard Part No. 5542271	Sector shaft seals for all M100 steering gears with a pressed-in excluder seal at the sector shaft with bolt on case
Sheppard Part No. 5543601	Sector shaft seals for all M100 steering gears with a push-on dust boot at the sector shaft and a snap ring cover
Sheppard Part No. 5543591	Sector shaft seals for all M100 steering gears with a pressed-in excluder seal at the sector shaft and a snap ring cover

**Lubrication - Steering Gears**

**FLUID RECOMMENDATIONS**

The lubricant used in the power steering system lubricates moving parts and removes heat. Too much heat reduces efficiency and increases wear. It is important to use the lubricant specified by the Vehicle Manufacturer and approved by the R. H. Sheppard Co., Inc.

R. H. Sheppard Co., Inc. approves the use of the following fluids in the M-Series steering gear:

**R. H. Sheppard Company Approved Fluids for Power Steering**

Automatic Transmission Fluid Dexron II	Flestrite PSF (Can #990625C2)	Shell Rotella T SAE 30
Automatic Transmission Fluid Type "B" or "F"	Ford Spec. M2C138CJ	Texaco 10W40
Chevron 10W40	Mack BO-K2 Engine Oil	Texaco Code 1831 Power Steering Fluid 11872
Chevron Customer 10W40 Motor Oil	Mobil 1 15W50 Motor Oil	Texaco Code 1854 Mercon / Dexron III
Cummins Premium Blue 2000 15W40	Mobil ATF 210	Union 10W40
Drydene XHD 15W40	Mobil Super 10W40 Motor Oil	Union 15W40
Drydene MP Dexron II/ Mercon ATF	Mobil Super 15W40 Motor Oil	Unocal 46 Power Steering Fluids
Exxon Auto H32 Hydraulic Fluid	Shell Rotella T30W	Unocal Guardol 15W40 Motor Oil
		Valvoline All-Climate 10W40 Motor Oil

## DIAGNOSIS & TROUBLESHOOTING

This section of the manual is designed to help the mechanic troubleshoot steering complaints. Used properly the section will assist you in completing a proper and less time consuming diagnosis and repair.

You will find sub sections covering diagnosis, troubleshooting, definitions and terms for complaints. To properly repair the problem you must have a clear understanding of the driver's complaint. The Glossary of Terms and Definitions will help pin point the problem quickly.

Locate the complaint in the troubleshooting section and complete all the necessary tests as outlined in the proper section of this manual. Complete the troubleshooting checklist and record your findings.

If after completing the diagnosis and repairs found in the Diagnosis and Troubleshooting section of this manual, you are unsure of your findings, contact the Field Service Department of the R. H. Sheppard Co., Inc. at 717-633-4111. When contacting the R. H. Sheppard Co. with a problem be sure to have your completed troubleshooting checklist available.

Do not remove the gear until you have completed all procedures to solve your problems. Remember the steering gear is only one part of a total steering system. Many factors outside the steering gear will affect steering performance.

## DIAGNOSIS AND TROUBLESHOOTING

**IMPORTANT:** Do Not Remove The Steering Gear From The Vehicle

To properly diagnose steering complaints it is important to understand the complete steering system. Many factors outside of the steering system will affect steering performance. Factors such as misalignment, looseness in front end components, mismatched tires and dry fifth wheel, to name a few, will affect steering.

A trouble shooting checklist is provided in the Miscellaneous Section of this manual. This form can be removed and photo copied. This checklist will follow the diagnosis outline below.

### GENERAL DIAGNOSIS

Many times a steering gear is removed and disassembled needlessly because an orderly diagnostic procedure is not followed.

A glossary of common terms is provided at the end of this section of the manual. This glossary is intended to help you better understand the problem.

Begin your diagnosis using the following outline as a guide.

- I. **DEFINE THE COMPLAINT**
  - a. Talk to and question the driver - Refer to the glossary to obtain a clear understanding of what the driver is saying.
  - b. Drive the vehicle - If possible have the driver show you what he is experiencing. Drive the vehicle together to duplicate the condition.
- II. **PERFORM A VISUAL INSPECTION OF THE VEHICLE**
  - a. Check for dry fifth wheel - Lack of lubrication will tend to steer the vehicle.
  - b. Check tires for mismatch, improper inflation or uneven wear patterns.
  - c. Check for poor loading practices - Special body or equipment installations should be checked for their effect on steering performance.
  - d. Check for suspension sagging or shifting - Out of line rear axles will tend to steer the front end of the vehicle.
- III. **INSPECT MECHANICAL COMPONENTS**
  - a. Check all front axle components for wear, looseness or seizing.
  - b. Inspect steering column for drag - more than 10 inch pounds of drag measured with the column suspended at the angle of operation is excessive.
  - c. Check steering gear mounting to be sure that it is tight. A steering gear that is shifting on the frame will affect steering performance.
- IV. **CHECK THE HYDRAULIC SUPPLY SYSTEM**
  - a. Follow the procedures as outlined in the hydraulic diagnosis section of this manual. Oil pressure and flow must be within the vehicle manufacturer's specifications.

### HYDRAULIC DIAGNOSIS

The Sheppard M-Series integral power steering gear is a reactionary part of the power steering system. By reactionary we mean that its operation is dependent on the proper supply of oil pressure and flow from the hydraulic supply pump.

When the steering wheel is turned, oil flow is applied to one end of the steering gear piston causing pressure to build. This pressure causes the piston to move. As the piston moves it is displaced by a volume of oil under pressure. The speed the piston moves is dependent on the amount of oil flow or,

**Flow** = Speed of steering.

Maximum system relief pressure limits the amount of steering gear output available to steer your specific vehicle or,

**Pressure** = The amount of work the steering gear can do.

Keeping the basic formula of "Flow = Steering Wheel Speed" and "Pressure = Work" in mind will help you diagnose steering problems.

Oil pressure and flow requirements are set during the design of the steering system. When diagnosing steering problems, oil pressure and flow must meet design specifications. Pressure and flow specifications vary. Follow the vehicle manufacturer's recommendations.

System back pressure and operating temperature must be considered during the diagnosis of the steering system. High system back pressure will create heat.

High system oil temperatures reduce overall efficiency of the steering pump and steering gear.

Various types of pressure and flow meters are available to diagnose power steering problems. A pressure gauge rated at 3000 PSI and a flow meter with a capacity of 10 GPM are needed to check oil pressure and flow.

A shutoff valve placed downstream from the pressure gauge allows the hydraulic supply pump to be isolated from the gear to check pump relief pressure. A simple thermometer placed in the reservoir will show system temperature.

Pictured below is the Sheppard Heavy Duty Power Steering Test Kit Part #5517641. This is an excellent tool for troubleshooting power steering systems and can be ordered using the form in the Miscellaneous section of this manual.



This tester is a self contained, direct reading device to check system flow, pressure or both at the same time. It can detect worn components, check flow and pressure control settings or monitor overall system performance.

#### LOW COST - EASY TO USE

Only one hose connection is broken, either at the pump output or at the pressure input to the power steering gear housing.

- \* Installs between pump and steering gear
- \* Shutoff valve isolates pump from gear
- \* Pressure and flow can be read at the same time
- \* 0-3000 P.S.I. pressure gauge
- \* 1-10 G.P.M. flow meter
- \* Complete with hoses & standard swivel fitting

**WARNING** OIL UNDER PRESSURE CAN PENETRATE THE SKIN CAUSING SEVERE INJURY. NEVER USE YOUR HANDS TO CHECK FOR LEAKS

Using a pressure and flow test kit, proceed with the evaluation of the hydraulic system. Record your findings on the trouble shooting checklist.

**NOTE:** All tests must be performed with the vehicle parked on a clean, dry, solid surface, with the engine running and the full weight of the vehicle on the front wheels.

1. Connect the pressure and flow tester in series with the pressure line of the pump. Make a copy of the trouble shooting test sheet.
2. Start the engine and check system oil level. Make sure the oil is flowing in the proper direction as indicated by the arrow on the flow meter.
3. Place a thermometer in the reservoir.
4. Run the engine at idle speed. Slowly close the shut off valve until you have a pressure reading of 1000 PSI. Maintain this pressure until system temperature reaches 180 degrees Fahrenheit. Open the shutoff valve all the way when the temperature is 180 degrees.
5. Check System Backpressure:  
Normal system back pressure will be between 0 and 100 PSI with the engine idling and the steering wheel stationary. Dual systems will normally read slightly higher. Back pressure should be checked at normal operating temperature.
6. Pump Maximum Relief Pressure:  
With the engine running at specified idle speed, slowly turn the shutoff valve until it is closed and read the pressure at which the pressure relief valve opens. (Open the shutoff valve as quickly as possible to avoid heat build-up or possible damage to the steering pump.) This pressure reading should equal the maximum pump pressure specified by the vehicle manufacturer. Check specifications.

**WARNING** A BAD PRESSURE RELIEF VALVE MAY NOT RELIEVE PUMP PRESSURE. CLOSING THE SHUTOFF VALVE MAY CAUSE SEVERE PUMP DAMAGE OR HIGH-PRESSURE HOSES TO RUPTURE. WATCH THE PRESSURE GAUGE CLOSELY. IF PRESSURE RISES RAPIDLY OR GOES ABOVE 2500 PSI. STOP! DO NOT CLOSE THE VALVE ALL THE WAY.

SOME STEERING PUMPS ARE NOT EQUIPPED WITH INTEGRAL RELIEF VALVES. CLOSE THE SHUTOFF VALVE SLOWLY AND WATCH THE PRESSURE. IF SYSTEM PRESSURE GOES ABOVE 2500 PSI DO NOT CONTINUE TO CLOSE THE SHUTOFF VALVE. PUMP DAMAGE OR PERSONAL INJURY MAY RESULT.

7. Flow Test:  
Measure oil flow under the following conditions. Record your findings on the Trouble Shooting Checklist.  
Flow at idle with back pressure only  
Flow at idle under a 1500 PSI load applied with the shutoff valve  
Flow at full governed RPM with back pressure only  
Flow at full governed RPM under a 1500 PSI load applied with the shutoff valve
8. Aerated Oil:  
Visually check for air mixed with the oil in the steering system. The oil should be clear. Any signs of frothing indicates air in the system and steering performance will be affected. Carefully check for leakage on the suction side of the steering pump. Drain, refill, and bleed the system. Follow the procedure for setting relief plungers in the "Common Procedures" section of this manual.  
  
Before any steering gear repairs are made complete the hydraulic supply evaluation and make any repairs. Many times steering gears have been repaired or replaced needlessly because a hydraulic supply system evaluation had not been made.  
  
Additional references to pressure and flow testing will be made in the diagnosis charts in the "General Diagnosis" section of this manual.
9. Dry park Pressure and Input Effort:  
Measure and record the pressure required to steer the vehicle from full left to full right while parked. Input effort is measured at the steering wheel retaining nut. Use a dial type inch pound torque wrench to check static steering input effort. Normal Input effort will be less than 100 inch pounds.

## OIL FLOW AND PRESSURE RECOMMENDATIONS

The Sheppard M-Series power steering gears are designed to operate at a maximum pressure of 2175 PSI. Each vehicle Manufacturer specifies the maximum operating pressure at which their various steering installations are to be operated. Always refer to your Vehicle Manufacturer's specifications for the correct pump relief settings for the vehicle you are working on.

 <b>WARNING</b>	<b>DO NOT INCREASE THE MAXIMUM OPERATING PRESSURE WITHOUT CONSULTING THE VEHICLE MANUFACTURER. SERIOUS DAMAGES MAY OCCUR.</b>
--	---

Oil flow and pressure for the Sheppard M-Series steering gears are outlined below by model number. Refer to the gear identification section of this manual to determine the model of steering gear you are working on. Oil flow requirements remain the same for all similar models and do not change from installation to installation. Follow the Vehicle Manufacturer's recommendation.

M-SERIES STEERING GEARS

	M80P	M90P	M100P	M110P
<b>RATED PRESSURE</b>	2175 PSI	2175 PSI	2175 PSI	2175 PSI
<b>MIN. PUMP FLOW (SINGLE)</b>	2.1 GPM	2.5 GPM	3.0 GPM	3.5 GPM
<b>PUMP FLOW RANGE (SINGLE)</b>	2.5-6.0 GPM	2.5-6.0 GPM	3.0-6.0 GPM	3.5-6.0GPM
<b>PUMP FLOW RANGE (DUAL SYSTEM)</b>	N/A	4.6-6.0 GPM	5.1-6.0 GPM	5.6-6.0 GPM
<b>RATIO</b>	16.8-1	18.9-1	18.9-1	23-1
<b>OUTPUT SHAFT DIAMETER</b>	1.75 IN.	2.0 IN.	2.0 IN.	2.25 IN.

DIAGNOSIS & TROUBLESHOOTING

Before any steering gear repairs are made complete the entire troubleshooting checklist provided in this manual. Many times steering gears are removed or replaced needlessly. Remember, once the steering gear is removed there is only one thing that can be determined -its weight!!!

If you have completed the troubleshooting checklist and are unsure of your diagnosis contact your Vehicle Manufacture representative, or the Field Service Department of the R. H. Sheppard Co., Inc. at 800-274-7437.

## GLOSSARY

1. **Rotary Valve** - Internal valve in the bearing cap of the steering gear. It is actuated by the steering wheel through the yoke connection of the steering column.
2. **Back Pressure** - Circulating pressure of the steering system.
3. **Base Mounted Gear** - The steering gear is mounted to the frame rail or bracket utilizing the eight mounting holes opposite the sector shaft cover.
4. **Bearing Cap** - End cap of the steering gear that houses the actuating shaft and valve.
5. **Bearing Cap Cover** - Small cover on the end of the bearing cap of the steering gear. The bearing cap cover houses the input shaft oil and salt seal.
6. **Bleeder Screw** - 1/8" allen screw located in the sector shaft bore of the steering gear.
7. **Cavitation** - Bubbles that form in the oil which keep the pump from supplying pressure and volume.
8. **Contamination** - Dirt or other foreign material in a fluid.
9. **Cylinder Bore** - Long bore of the steering gear where the steering gear piston is housed.
10. **Cylinder Head** - The end cap of the steering gear bolted on the housing opposite the actuating shaft end of the gear.
11. **Displacement** - The volume of fluid that can pass through a pump or cylinder in a single revolution or stroke.
12. **Feedback** - A transfer energy from the output of a device to it's input.
13. **Fluid Flow** - The stream or movement of a fluid, or the rate of it's movement.
14. **Piston** - Is found in the cylinder bore. Changes the hydraulic force to mechanical force in the steering gear.
15. **Plunger** - Relief valves in the steering gear to limit steering gear piston travel. Plungers are adjustable and can be either manual or automatic adjusting.
16. **Pressure Relief Valve** - Optional pressure relief valve integral to the steering gear to limit system operating pressure. Identified by a large hex nut on the side of the bearing cap.
17. **Pump** - A device that converts mechanical force and motion into hydraulic fluid power.
18. **Rack Teeth** - The area on the piston that engages the sector shaft teeth.
19. **Recirculation Ball Thread** - The area of the rotary valve on which the 24 steel balls travel.
20. **Relief Valve** - A pressure control valve used to limit system pressure.
21. **Sector Shaft** - The shaft the pitman arm is attached to.
22. **Sector Shaft Bore** - Area of the steering gear that houses the sector shaft.
23. **Slave Gear** - Right hand gear in a dual system application.
24. **Slave Ports** - Threaded openings in the cylinder head, bearing cap and sector shaft bore to install the pressure lines to operate the slave gear.
25. **Tab - Lock Retainer** - Bolt assembly used to provide initial torque when installing the pitman arm. Uses alignment tabs that fit into the pitman arm and restraining tabs to be locked into the head of the retainer.
26. **Flow** - The amount of fluid that passes a certain point in a unit of time. The volume of flow is usually expressed in gallons per minute for liquids.

## TROUBLESHOOTING GUIDE

This section is designed to give you causes and possible remedies for the most common problems.

Symptom	Possible cause	Remedy
Oil leaking at output shaft of steering gear.	Damaged sector shaft seal	Replace sector shaft seal and sector shaft if necessary
Oil leaking at actuating shaft of steering gear	Worn or damaged oil seal	Replace actuating shaft seal
Oil leaking at supply pump drive shaft	Damaged oil seal Oil seal heat damaged Loose or damaged bushing on pump drive shaft	Replace oil seal Check operating temperature Repair pump per pump service instruction
Lubricant milky or white in appearance	Water entry through reservoir venting system	Clean vent system or replace cap assembly Flush System
Oil forced out of reservoir or foaming	Clogged oil filter	Change oil and oil filter Change more often
	Air in system	Bleed air from system Check for air leak on suction side of supply pump
	Relief plungers of steering gear not adjusted properly creating high operating temperatures	Adjust relief plungers (See Common Procedures)
	Air leak in suction side of supply pump	Refer to pump servicing instructions
	Pump cavitating	Check for restriction in pump supply
	Oil overheating	Check for restriction in steering gear return
Engine oil in power steering reservoir (Gear driven pump)	Faulty seal at pump drive shaft	Repair pump
	Faulty seal at accessory shaft driving supply pump	Repair accessory drive
Lubrication oil discolored	Operating temperatures too high	Check and correct cause of overheating
	Change intervals too long Incorrect lubricant used	Change oil more often Drain, flush and refill with recommended fluid
High operating temperatures	Oil flow restriction	Check back pressure
	Oil flow too high	Check maximum oil flow



Symptom	Possible cause	Remedy
<b>No power steering on cold starting</b>	Hydraulic supply pump vanes not extending (Vane type pump only)	Increase engine speed momentarily to extend vanes and start pump action. Usually does not happen often and does not last long. Not a cause for pump repair or replacement.
<b>Excessive pump pressure with steering gear in neutral position.</b>	Pinched oil return line High back pressure	Relocate line
	Binding steering column	Repair steering column
<b>Wheel cuts restricted</b>	Relief plungers not adjusted properly	Adjust relief plungers
<b>Erratic steering or mechanical steering only</b>	Insufficient volume of oil	Refer to pump servicing instructions
	Sticking pressure relief valve in steering gear	Replace relief valve as required
<b>Hard Steering</b>	Faulty supply pump	Check pump flow
	Steering out of alignment	Align front end
	High operating temperature	Locate and correct cause of overheating
<b>Wheel turns hard in one or both directions</b>	Bind in steering column	Check column drag
	Dirt or foreign matter trapped in piston relief	Check piston relief
	Bent or damaged king pins and tie rods	Repair or replace king pins and tie rods Refer to servicing instructions
	Front end load too great	Lighten load
	Low oil level in steering system	Fill oil reservoir as required
	Air in system	Bleed system and check for cause of air
	Caster degree incorrect	Correct to Specifications
<b>Wheel turns hard in one direction</b>	Metal or foreign material in relief ball seat in piston of steering gear	Remove and clean relief valve seats or replace damaged parts
<b>No attempt to return to straight ahead from turns (may also be hard steering complaint)</b>	No positive caster	Set caster to 3° to 5° positive caster

Symptom	Possible cause	Remedy
	Steering gear mounting distorted	Shim mounting pads to correct piston to bore interference. Make sure correct bolt length is used on the base mount gears.
	Linkage ball sockets seized or binding	Check and repair or replace
	King pins seized or binding	Repair or replace
	Oil flow rate incorrect	Check and correct supply pump
<b>Darting, wandering (oversteering)</b>	Oil flow too high	Supply pump not to specifications
	Air trapped in steering gear	Bleed system
	Looseness, worn front end parts	Check and repair as required
	Front end alignment not correct	Align front end caster
	Overloading	Reduce loads
	Rear axle not parallel	Check & repair as required
	Tight tie rod ends & drag link sockets	Check rotational torque & replace if necessary
<b>Excessive backlash/freeplay</b>	Worn universal joint	Replace universal joint
	Pitman arm ball worn "egg-shaped" (if equipped)	Replace pitman arm assembly where riveted ball is used.
	Loose bracket frame to bracket or bracket to gear	Remove bracket, clean frame and bracket. Check radius of frame making sure bracket is not bearing on radius surface. Check bracket for wear from being loose. Replace bracket and tighten to recommended torque rating by size and grade of bolts. If necessary, replace bracket.
	Rack on piston damaged	Replace steering gear
	Damaged sector shaft/splines	Replace steering gear
	Worn or damaged pitman arm splines	Replace pitman arm and sector shaft
	Universal joint yoke loose on actuating shaft	Repair or replace damaged parts.

Symptom	Possible cause	Remedy
Steering input not smooth	Worn universal joint	Check and replace as required
	Lack of lubrication	Lubricate per vehicle manufacturer's recommendations
	Universal joints not phased properly	Re-phase columns*
	Low oil flow	Idle speed too low Drive belts slipping Supply pump not to specifications
	Overload on front axle	Verify front axle weight. Do not exceed rating of front axle.
	Pump cavitating	Correct pump supply
	Overheating	Correct cause of overheating

**NOTE:** Universal joints are designed to operate best when the angle between the drive and driven shaft is a maximum of 20 to 25 degrees. Angles greater than this may upset steering performance.

**IMPORTANT:** Actuating shaft thread wear generally comes from improper lubrication or excessive manual steering. Manual steering results from low pump pressure or flow or an overloaded front axle.

\*To check phasing of the universal joints in the steering column, use an inch-pound graduated dial type torque wrench. With a socket on the steering wheel retaining nut, read the difference in the torque while steering from lock-to-lock. Variation of more than 15 in.-lb. means improper phasing. Take the reading with the vehicle stationary and the engine running at idle.

Phasing can usually be corrected by rotating the two-piece intermediate shaft one spline at a time until the torque reading remains the same throughout the 360 degree rotation of the steering wheel.

## Common Procedures

This section of the service manual covers repairs that do not require removal of the power steering gear. Before you attempt repairs, read the procedure and make sure you have all the parts, tools and information needed to finish the job. Always refer to the Vehicle Manufacturer's Service Manual and any service bulletins covering the vehicle you are working on.

Read all the safety warnings. These warnings have information critical to the safe operation of the steering gear and the vehicle.

Additionally, you will find notes, cautions and items marked "Important". These items give information to ensure that you are following proper procedures. They are designed to keep repair times to a minimum and assure a quality repair.

If problems arise during repair or you are unsure of a procedure, call the Field Service Department of the R. H. Sheppard Co. at 717-633-4111 for assistance.



### WARNING

REPAIRS TO HEAVY DUTY POWER STEERING SYSTEMS MUST BE MADE BY HIGHLY TRAINED PROFESSIONAL MECHANICS.

FAILURE TO FOLLOW SAFETY PROCEDURES COULD RESULT IN LOSS OF STEERING, ACCIDENT DAMAGE OR PERSONAL INJURY.

## Preventive Maintenance

Fluid and filter change is necessary to keep the fluid in the system clean. The use of high quality fluids and filters will insure the removal of contaminants and dissipate heat.

### TOOLS REQUIRED:

Drain pan  
Shop towels  
10" adjustable wrench  
Hydraulic jack of a suitable size  
Screwdriver



### WARNING

FOR OTHER EQUIPMENT, TOOLS OR SAFETY PROCEDURES ALWAYS FOLLOW THE VEHICLE MANUFACTURER'S PROCEDURES FOR LIFTING AND BLOCKING. CLEAN UP ALL OIL SPILLS TO AVOID SLIPS AND FALLS.

### PARTS REQUIRED:

Specified steering fluid  
Specified filter



### WARNING

NEVER USE OLD OR USED SEALS, COTTER PINS, RETAINERS OR CRITICAL FASTENERS. ALWAYS BUY A NEW SEAL KIT. USE ONLY MANUFACTURER APPROVED REPLACEMENT

### ADDITIONAL REFERENCES:

Vehicle Manufacturer's Service Manual  
R. H. Sheppard Co., Inc. Maintenance and Troubleshooting Video

### PROCEDURE:

1. Park the vehicle on a clean, dry, solid surface. Set the parking brake, block the rear wheels and place the transmission in neutral.
2. Raise the front end of the vehicle until the tires have cleared the surface using the hydraulic jack.
3. Tilt the hood or raise the cab using the procedure in the Vehicle Manufacturer's Service Manual.
4. Place the drain pan under the steering gear to catch the fluid.
5. Remove the pressure and return lines from the steering gear to drain fluid.
6. Wipe off the area around the reservoir cap with a clean towel. Remove the bolt from canister type reservoirs. Remove the cover.
7. Remove the filter from the canister and discard. If a spin on filter is used remove the filter using the filter wrench and discard.

**IMPORTANT:** Discard only the filter element. The other parts may be used to retain the filter in the reservoir assembly.

8. Wipe the inside of the reservoir canister clean with a clean shop towel.
9. With the hoses disconnected, slowly turn the steering wheel from full left to full right three or more times to purge oil from the steering gear. Make sure the drain pan will catch the oil from the steering gear.
10. Attach the pressure and return lines to the steering gear and tighten.
11. Install a new filter element in the reservoir. Follow the directions on the filter element and refer to the Vehicle Manufacturer's Service Manual.

12. Clean the reservoir cap with an approved solvent. Remove the old gasket from the cap and replace it with a new gasket. For vehicles with a spin on filter element, replace the filter with using procedures in the Vehicle Manufacturer's Service Manual.
13. Fill the reservoir with new steering fluid to within 1" of the top of the reservoir canister. Install the reservoir cover and tighten the bolt to the Vehicle Manufacturer's specification.
14. Start the vehicle and allow it to idle.
15. Check the fluid level and fill as needed.
16. Steer the vehicle from full left to full right several times and check the fluid level again. Add fluid as needed.
17. Visually check all fittings and hoses for external leaks.

**CAUTION** Do not allow the reservoir to empty during start up. Pump damage may result.

18. Shut the vehicle off. Remove the drain pan, lower the vehicle until the tires contact the surface and remove the jack.
19. Lower the cab or hood using the procedures in the Vehicle Manufacturer's Manual.

**WARNING** DO NOT CHECK FOR LEAKS BY HAND, HYDRAULIC OIL UNDER PRESSURE CAN PENETRATE THE SKIN AND CAUSE SEVERE INJURY.

**NOTE:** A note on mixing oils and additives-Chemicals tend to react with one another. Some interactions are of no consequence. Others are beneficial, while still others may cause some degradation in the service capability. It is not recommended to mix products which are intended for different service applications, for instance, a transmission and a gear oil.

Since the original lubricant manufacturer puts a lot of time and expense into ensuring that their oil will meet the required qualifications, it is not a good idea to introduce additional chemical which may upset the delicate and critical balance originally obtained. This means that supplemental additives are not needed and normally are not desired in a fully compounded and qualified lubricant.

## Input Shaft Seal Replacement

(Current Production after July '1991)

**IMPORTANT:** Do not remove the steering gear for this repair.

### TOOLS REQUIRED:

Appropriate size sockets and drivers to remove U-Joint pinch bolt and bearing cap mounting bolts  
 Drain pan  
 5/8" & 11/16" combination wrenches  
 0-150 ft./lb. torque wrench (minimum)  
 Screw driver  
 1" Socket & short extension (1/2" drive)  
 Small hammer

**WARNING** FOR OTHER EQUIPMENT, TOOLS OR SAFETY PROCEDURES ALWAYS FOLLOW THE VEHICLE MANUFACTURER'S PROCEDURES FOR LIFTING AND BLOCKING.

### PARTS REQUIRED:

5542261 Input Shaft Seal Kit  
 Specified fluid

**WARNING** NEVER USE OLD OR USED SEALS, COTTER PINS, RETAINERS OR CRITICAL FASTENERS. ALWAYS BUY A NEW SEAL KIT. USE ONLY MANUFACTURER APPROVED REPLACEMENT PARTS.

### ADDITIONAL REFERENCES:

Vehicle Manufacturer's Service Manual  
 R. H. Sheppard Co. Maintenance & Troubleshooting Video (Optional)

### PROCEDURE - Disassembly:

**NOTE :** Removal of the power steering gear is not necessary to complete this repair.

1. Park the vehicle on a clean, dry, solid surface, preferably concrete. Set the parking brake and block the wheels. Place the transmission in neutral.
2. Tilt the hood or cab using the procedure in the Vehicle Manufacturer's Service Manual.
3. Loosen and remove the pinch bolt on the lower end yoke of the steering shaft.
4. Remove the lower yoke from the steering gear input shaft. If necessary, secure the shaft so it will not be in the way.

**IMPORTANT :** Do not pull the slip shaft out of the steering shaft. This would require rephasing at time of installation.

5. Place the drain pan under the power steering gear. Draining the system is not necessary, but some fluid will be lost.



**CAUTION** Make sure the cap you are working on has a rubber lip seal before attempting repair

- Remove the rubber dust boot. Using the ratchet and socket, remove the four attaching bolts from the bearing cap cover and remove the bearing cap cover



**WARNING** DO NOT TURN THE INPUT SHAFT DURING REPAIRS. DAMAGE TO THE STEERING GEAR WILL RESULT.

**CAUTION** The thrust washer will stick to the bearing cap cover. Install the thrust washer before proceeding



- Place the bearing cap cover on a clean work surface. Pry the salt seal out of the bearing cap cover



- Press the oil seal out of the cover using a suitable size socket or seal driver. Use of an arbor press is recommended. Remove the o-ring from the cover. Discard all seals.



- Clean the cover with a suitable solvent. If the cap you are working on has a grease fitting, remove the grease fitting and fill the hole with RTV compound. No further greasing is required.



## Reassembly



1. Place the cover face down on a clean work surface. Install the oil seal in the cover using a suitable size seal driver and an arbor press. Coat the outside diameter of the seal with clean chassis lube. Make sure the lip of the seal faces up when installing the seal. The garter spring will be visible when properly installed.

**NOTE:** The input shaft seal is a press fit. If the seal seems too small, contact Sheppard @1-800-274-7437



2. Install a new o-ring on the bearing cap cover. Make sure the oil seal is properly installed before proceeding.



3. Press the seal into the cover until it is flush with the face of the cover.

**NOTE:** Tape the input shaft splines before installing the cover to prevent seal damage.



4. Install the bearing cap cover onto the steering gear and torque the attaching bolts to specification. Install the rubber boot over the input shaft. Insure the boot is below the spine and contacts the cover when installed.
5. Remove the tape from the splines and install the u-joint following the vehicle manufacturer's instructions.
6. Check and correct the fluid level in the power steering reservoir.
7. Start the vehicle and check for leaks. Remove the drain pan and lower the hood or cab following vehicle manufacturer's guidelines.

## Sector Shaft Seal Replacement

### Do Not Remove the Steering Gear for This procedure

Partial disassembly of the steering gear is required to replace the sector shaft seals. Take care to time the sector shaft if it is replaced.

#### Tools Required:

Drain Pan  
 Hammer  
 Punch  
 Appropriate Size Allen Drive socket  
 Sheppard Pitman Arm Puller (Kent Moore #ZTSE-4439)  
 Sockets & ratchet  
 Large Snap Ring Pliers  
 Seal Driver

#### Procedure:

1. Park the vehicle on a clean dry surface. Set the parking brake and chock the wheels. Tilt the hood or cab to gain access to the steering gear.
2. Remove the pitman arm following the procedures in the Pitman Arm Removal Section of this manual.
3. Remove the rubber boot from the sector shaft and discard. Snap Ring covers may be equipped with a protective cap. Pry the cap out of the bore at this time.
4. There are three variations of sector shaft covers. Use appropriate procedures for removal of the cover you are working with. You will need either the snap ring pliers, socket and ratchet or Allen drive sockets to remove the particular attachment method you are working with.

**IMPORTANT:** You will need to remove the factory installed silicone protectant from the snap ring and carefully clean the cover area before disassembly when working with snap ring covers.

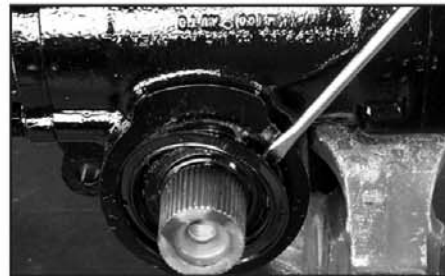

5. Clean the shaft and remove the sector shaft cover. It may be necessary to crank the engine to force the cover out of the housing

**WARNING** DO NOT TURN THE WHEEL DURING THIS PROCEDURE! CIRCULATING OIL WILL FORCE THE COVER OUT. TURNING THE WHEEL WILL CAUSE A PRESSURE INCREASE AND PERSONAL INJURY MAY RESULT!



**NOTE:** A slide hammer may be used to remove the sector shaft if necessary.

6. Remove the sector shaft and cover from the housing. Separate the cover from the sector shaft. Inspect the sector shaft for corrosion or damage. Replace the sector shaft if necessary.

**NOTE:** It may be necessary to remove the dust cover from the frame side of the sector shaft. Use a gasket scraper or screwdriver to remove the frame side dust cover.



7. Pry the excluder seal from the cover. Using a seal pick, remove the oil seal from the sector shaft cover and housing. Remove the O-ring from the cover. Discard all seals.



8. Install a new oil seal in the housing and cover. Take care to install the oil seal with the black lip toward the inside of the gear and the blue side facing the outside of the gear

**WARNING** THE SECTOR SHAFT OIL SEALS ARE TWO PIECE SEALS IT WILL BE NECESSARY TO BEND THE SEAL TO INSTALL IT INTO THE COVER AND HOUSING. ONCE THE SEAL IS IN PLACE, IT MAY BE NECESSARY TO SEAT THE SEAL INTO PLACE USING YOUR FINGERS OR A BLUNT SEAL PICK. TAKE CARE TO PUSH ONLY ON THE BODY OF THE SEAL AND NOT ON THE SEAL LIP!



**NOTE:** Coat all seals with a light coat of clean motor oil to facilitate installation of the sector shaft.

9. Install the sector shaft into the housing taking care to align the timing mark on the sector with the timing marks on the piston. It may be necessary to tap on the sector shaft to properly seat it into the housing.

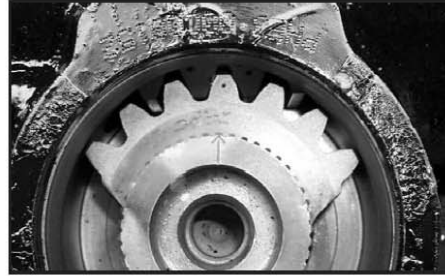

10. Install the sector shaft cover onto the steering gear. Insure that the cover is properly seated when installing. Snap ring covers must be flush or below the snap ring groove when properly installed.



11. Install the snap ring or attaching bolts in the cover.

**WARNING** FAILURE TO PROPERLY INSTALL THE SNAP RING CAN CAUSE THE SNAP RING TO DISENGAGE AND PERSONAL INJURY WILL RESULT!

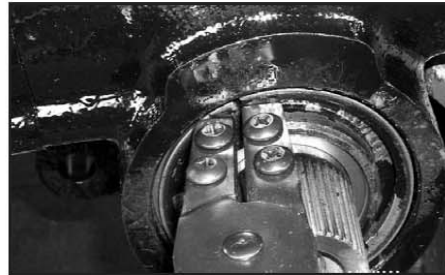

12. Using an appropriate size seal driver, install the excluder seal in the cover. Apply a coat of clean chassis lube in the lip of the seal before installing. Apply a bead of grease over the excluder seal and slide the rubber boot over the sector shaft.

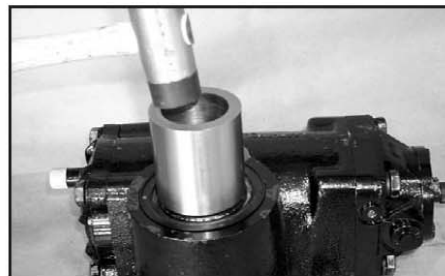

13. Install the pitman arm following the procedures in the Pitman Arm Installation section of this manual.

14. Fill the system with an approved fluid. Start the engine, check and correct fluid level.

15. Lower the hood or cab following the vehicle manufacturers guidelines.

COMMON PROCEDURES

## Bleeding Single Gear System

Bleeding of the steering gear in a single gear system is only necessary if the gear is mounted in a way that will trap air in the sector shaft bore. This procedure should be followed whenever the gear has been disassembled or replaced.

### TOOLS REQUIRED:

1/8" Allen wrench

**WARNING** FOR OTHER EQUIPMENT, TOOLS OR SAFETY PROCEDURES ALWAYS FOLLOW THE VEHICLE MANUFACTURER'S PROCEDURES FOR LIFTING AND BLOCKING.

### ADDITIONAL REFERENCES:

Vehicle Manufacturer's Service Manual

R. H. Sheppard Co. - Maintenance & Troubleshooting Video (Optional)

### PROCEDURE:

1. Park the vehicle on a clean, dry, solid surface-preferably concrete. Set the parking brake and block the wheels. Place the transmission in neutral.
2. Tilt the hood or cab using the procedure in the Vehicle Manufacturer's Service Manual.
3. Make sure the fluid level in the reservoir is at the full mark of the dipstick.
4. If this is a replacement steering gear, follow the "Plunger Adjustment Procedures" in this section of the manual.
5. Start the vehicle and allow the engine to idle.
6. Steer the vehicle from full left to full right several times. The pitman arm must make full travel.



7. Locate the bleeder screw in the plug located on the sector shaft bore (Figure 34).

### IMPORTANT:

Do not turn the steering wheel with the bleeder open.

8. Using the allen wrench, open the bleeder screw until non-aerated fluid flows from the bleed screw.
9. Tighten the bleed screw.
10. Repeat steps 5-8 until no aeration is found in the bleed oil.
11. If this is a replacement steering gear, follow the "Plunger Adjustment Procedures" in this section of the manual.
12. Check the fluid level in the power steering reservoir and fill if necessary.
13. Shut the vehicle off.
14. Lower the hood or cab following procedures in the Vehicle Manufacturer's Service Manual.
15. Remove wheel blocks

## Bleeding Dual Gear System

Bleeding the dual steering gear system is necessary whenever the system has been repaired. Different gear sizes may be used together but the bleeding procedure is the same.

### TOOLS REQUIRED:

Hammer  
 1/8" Allen wrench  
 Ball stud removal tool  
 Hydraulic jack - appropriate size  
 0-200 ft./lb. Torque wrench (1/2" drive)  
 Socket and ratchet for drag link nut (1/2" drive)

**WARNING** FOR OTHER EQUIPMENT, TOOLS OR SAFETY PROCEDURES ALWAYS FOLLOW THE VEHICLE MANUFACTURER'S PROCEDURES FOR LIFTING AND BLOCKING.

### PARTS REQUIRED:

Cotter pins  
 Specified fluid

**WARNING** NEVER USE OLD OR USED SEALS, COTTER PINS, RETAINERS OR CRITICAL FASTENERS. ALWAYS BUY A NEW SEAL KIT. USE ONLY MANUFACTURER APPROVED REPLACEMENT PARTS.

### ADDITIONAL REFERENCES:

Vehicle Manufacturer's Service Manual  
 R. H. Sheppard Co. - Maintenance & Troubleshooting Video (Optional)

### PROCEDURE:

1. Park the vehicle on a clean, dry, solid surface-preferably concrete. Set the parking brake and block the wheels. Place the transmission in neutral.
2. Jack the vehicle up until the front wheels have cleared the surface.
3. Tilt the hood or cab using the procedure in the Vehicle Manufacturer's Service Manual.
4. Make sure the fluid level in the reservoir is at the full mark on the dipstick.

**IMPORTANT:** Do not allow the reservoir to empty during this procedure. pump damage or further aeration can result.

5. Remove the drag links from the pitman arms of the master and slave gears using the procedure in the Vehicle Manufacturer's Service Manual.
6. Start the vehicle and allow the engine to idle.
7. Turn the steering wheel to a full left turn and hold until the slave gear moves its full travel. Then turn the steering wheel to a full right turn and hold until the slave moves its full travel. Repeat this procedure three or more times.

8. Connect the drag link to the master gear. Torque the attaching nut following the procedures in the Vehicle Manufacturer's Service Manual

**CAUTION** Do not back off the nut when locating the cotter pin hole.

9. Install a new cotter pin through the ball stud nut, then lock in place.

**ANGER** FAILURE TO INSTALL A NEW COTTER PIN IN THE BALL STUD AFTER PROPER TORQUE COULD RESULT IN LOSS OF STEERING CONTROL

10. With the master gear drag link connected, turn the steering wheel to a full left turn and hold until the slave gear pitman arm moves its full travel. Then turn the steering wheel to a full right turn and hold until the slave gear pitman arm moves its full travel. Repeat this procedure three or more times.
11. Connect the drag link to the slave gear by turning the steering wheel until the pitman arm lines up with the drag link.

**IMPORTANT:**

Do not move the pitman arm by hand during this operation. Air may get in the system.

12. Torque the attaching nut following the procedures in the Vehicle Manufacturer's Service Manual.
13. Install a new cotter pin through the ball stud nut, then lock in place.
14. Steer the vehicle full left to full right several more times.
15. Locate the bleeder screw in the master gear located in the plug on the sector shaft bore



16. Using the allen wrench open the bleeder screw until non-aerated fluid flows from the bleed screw.

**NOTE:** Do not turn the steering wheel with the bleeder open.

17. Repeat the procedure on the slave gear if an M-Series slave is used.

18. Check and correct fluid level.

19. Shut the vehicle off.

20. Lower the the hood or cab following the procedure in the Vehicle Manufacturer's Service Manual.

21. Lower the vehicle until the tires contact the surface and remove the jack.





## Axle Stop Adjustment

Axle stop adjustment should be checked during pre-delivery. Axle stop positioning will determine the maximum wheel cut available for your truck and can be adjusted using the adjustable bolt and lock nut on each spindle. The following procedure is a guide. Refer to the OEM specifications for specific wheel cuts for your vehicle.

### TOOLS REQUIRED:

Hydraulic Jack  
Wrenches to fit Stop Bolts

### PROCEDURE:

1. Park the vehicle on a solid surface. Set the parking brake, chock the wheels and tilt the hood or cab to access the front tires.
2. Raise the front of the vehicle until the tires clear the surface.
3. Turn the wheels to a full right turn. Note the position of the tire relative to the steering gear or drag link. Adjust the stop bolt on the right spindle until a minimum clearance of 1" is maintained between the tire and any part of the chassis. This is the maximum wheel cut available.

 **WARNING** DO NOT EXCEED THE MINIMUM CLEARANCE OF 1", NEVER ALLOW THE TIRE TO CONTACT ANY PART OF THE CHASSIS. CONTACT OF THE TIRE WITH ANY PART OF THE CHASSIS WILL RESULT IN TIRE OR STEERING COMPONENT DAMAGE.

4. Turn the wheels to a full left turn. Note the position of the tire relative to contact with any part of the chassis or component. Adjust the stop bolt on the left spindle until a minimum clearance of 1" is maintained between the tire and any part of the chassis or component. This is the maximum wheel cut available.

 **WARNING** DO NOT EXCEED THE MINIMUM CLEARANCE OF 1", NEVER ALLOW THE TIRE TO CONTACT ANY PART OF THE CHASSIS. CONTACT OF THE TIRE WITH ANY PART OF THE CHASSIS WILL RESULT IN TIRE OR STEERING COMPONENT DAMAGE.

5. Make sure the jam nuts are tight on both axle stop bolts. Lower the vehicle, lower the hood or cab and remove the chocks.

## Alternate Bleed Procedure

### Single Gear System

In most cases, trapped air will bleed from the steering system by following the "Single Gear Bleeding Procedure." Air entrapment is most typical in applications where the sector shaft bore is above the piston bore on the steering gear as shown below. If you are unable to remove all the air following this procedure it may be necessary to bleed the system as follows:

1. With the full weight of the vehicle on the steer tires, start the truck and turn the wheels to a full left turn.
2. With the wheels turned full left, locate the bleeder screw above the pitman arm.
3. Using a 1/8" Allen wrench, open the bleed screw 2-3 turns.
4. With the bleed screw open, turn the wheels to a full right turn.
5. Close the bleed screw when a full right turn is achieved.

#### IMPORTANT:

Turning the wheels to a full right turn with the bleed screw open will force air from the system under pressure. DO NOT steer the truck to the left with the bleed screw open as this will introduce additional air into the system.

6. Repeat this procedure 2-3 times until all air is removed from the system.

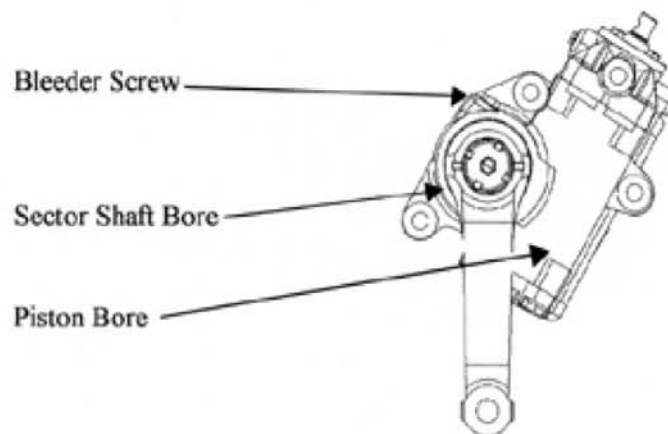

## Manual Plunger Adjustment

Relief plunger adjustment should be checked during pre-delivery. Any time tire size or steering gears are changed, relief plunger adjustment will be necessary. A relief plunger is located in each end cap of the steering gear; One for right turn, one for left turn.

### TOOLS REQUIRED:

Small blade screwdriver

**WARNING** FOR OTHER EQUIPMENT, TOOLS OR SAFETY PROCEDURES ALWAYS FOLLOW THE VEHICLE MANUFACTURER'S PROCEDURES FOR LIFTING AND BLOCKING.

### ADDITIONAL REFERENCES:

Vehicle Manufacturer's Service Manual

R. H. Sheppard Co. - Maintenance & Troubleshooting Video (Optional)

### PROCEDURE:

**NOTE:** Never attempt to adjust relief plungers until the axle stops are set following Vehicle Manufacturer's Specifications.

1. Park the vehicle on a clean, dry, solid surface-preferably concrete. Set the parking brake and block the wheels.
2. Place the transmission in neutral and start the engine.
3. Allow the engine to operate at idle speed.

**NOTE:** It is always best to have 2 people when setting plungers; 1 to steer the vehicle and 1 to set and check adjustments.

4. Locate the plungers.
5. Determine which plunger is used to adjust right and left turns based on direction of pitman arm travel.
6. Turn the steering wheel to a full left turn and check the clearance. If the clearance is not 1/8", plunger adjustment will be necessary.

**WARNING** IF THE STOP BOLT HITS THE AXLE UNDER PRESSURE, RELEASE THE WHEEL IMMEDIATELY! DAMAGE TO STEERING COMPONENTS MAY RESULT.

7. Return the front tires to the straight ahead position and release the steering wheel. Using the screwdriver, adjust the plunger for left turn. Turning the plunger in will increase the clearance between the stop bolt and the axle, while turning the plunger out will decrease the clearance. Do not adjust the plunger with pressure on the steering wheel. Seal damage can result.

**WARNING** NEVER ADJUST THE PLUNGER BEYOND FLUSH WITH THE END CAP. LEAKAGE OR PERSONAL INJURY MAY RESULT.

8. Turn the steering wheel to a full left turn. Check the 1/8" clearance.
9. If further adjustment is required, repeat steps 7 & 8 until the 1/8" clearance is achieved.
10. Repeat steps 6 thru 9 for the right turn.

## Set Automatic Plungers

Automatic plungers are set at the factory and do not need to be set unless tire size is changed or wheel cut is extended. It is recommended that the setting of automatic plungers be checked at pre-delivery. Do not adjust or set Auto Plungers unless axle gap is wrong or tire size is changed! All Sheppard Auto Plunger equipped steering gears are manufactured with the auto plungers set for minimum wheel cut. Once set following this procedure, no other adjustment or setting is required

### TOOLS REQUIRED:

Hydraulic Jack

### PROCEDURE:

1. Park the vehicle on a solid surface. Set the parking brake, chock the wheels and tilt the hood or cab to access the front tires.
  2. Verify that your steering gear has auto plungers. Steering gears with auto plungers will have the word "AUTO" cast into the housing as shown. Plastic caps on the plunger hole is a secondary means of verification
  3. Raise the front wheels until the tires clear the surface. Make sure axle stops are set to manufacturers specifications.
  4. Start the engine and turn the wheel to a full lock in both directions. Contacting the axle stop with the wheels off the ground will set the auto plunger to the correct position.
- NOTE:** As you reach the end of travel, you will feel the piston contact the plunger. Continue turning until you reach the axle stop bolt.
5. Return the wheels to straight ahead. Lower the vehicle.
  6. Shut off the engine. Lower the hood or cab and remove the wheel chocks.

## Adjust Automatic Plungers

Auto Plungers require NO ADJUSTMENT unless tire size is changed or wheel cut is reduced. Do not adjust auto plungers unless you are in one of these conditions!

### TOOLS REQUIRED:

1/4" Punch  
Ball Peen Hammer

### DO NOT USE A SCREWDRIVER TO ADJUST AUTO PLUNGERS!

### PROCEDURE:

1. Park the vehicle on a solid surface. Set the parking brake, chock the wheels and tilt the hood or cab to access the front tires.
2. Verify that your steering gear has auto plungers. Steering gears with auto plungers will have the word "AUTO" cast into the housing as shown. Plastic caps on the plunger hole is a secondary means of verification.
3. Remove the plastic caps from both plunger holes. Carefully insert the 1/4" plunger into the plunger hole and drive the auto plunger in until it bottoms in the bore. Repeat this procedure for both ends of the steering gear. Replace the plastic caps.

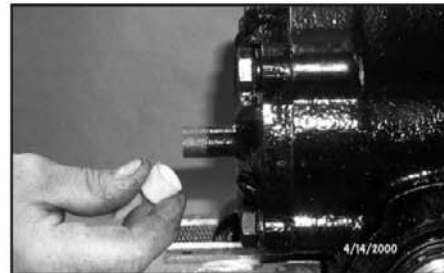

**WARNING** TAKE CARE WHEN USING THE PUNCH TO INSURE PLUNGER BORE IS NOT DAMAGED. A LEAK CAN OCCUR IF THE BORE IS DAMAGED DURING THIS PROCEDURE.

**IMPORTANT:** Make sure there are no sharp edges on your punch that could damage the bore.

4. Set the Auto Plunger following the "Set Automatic Relief Plungers" section of this manual.

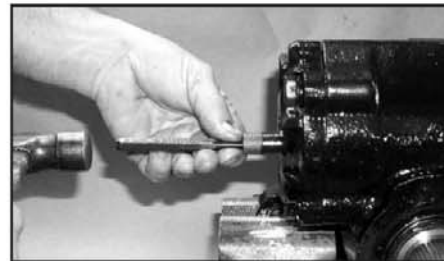

## Auto Plunger Repair Procedure

Under normal use the Sheppard Auto Plunger system requires no regular maintenance. The auto plunger is serviceable only as a kit and is only required if a leak is present. Sheppard part number 18212821K will fit both the cylinder head and bearing cap end of the steering gear.

### TOOLS REQUIRED

Various Metric Sockets and Ratchet  
 Slotted Screwdriver Bit and Suitable Socket and Ratchet  
 1/4" Drift Punch  
 1/4" Pin Punch  
 1/4" Center Punch  
 10mm open End Wrench  
 Hammer

### CYLINDER HEAD REPAIR PROCEDURE

1. Park the vehicle on a clean dry surface (preferably concrete). Set the parking brake and block the wheels. Tilt the hood or raise the cab following the procedures outlined in the vehicle manufacturer's service manual. Identify the steering gear as being equipped with auto plungers. If you have a question on identifying the steering gear, contact the Field Service Department of the R. H. Sheppard Co. Place a drain pan under the steering gear.
2. Mark the cylinder head and housing for re-assembly. Remove the four attaching bolts from the cylinder head using an appropriate size socket and ratchet. Remove the cylinder head.
3. Place the cylinder head in a vise. Remove the plastic plug from the auto plunger hole. Using a 1/4" punch and hammer, drive the auto plunger assembly in until it bottoms in the bore. The spring pin, flange and plunger body should be accessible for repair at this point.

**CAUTION** Failure to keep the 1/4" punch straight in the bore or hitting the plunger too hard can result in damage to the steering gear or auto plunger assembly.

4. Carefully insert the screwdriver bit into the plunger bore to engage the slotted head of the plunger body. Using the 10mm open end wrench to hold the flange across the flat sides, carefully turn the flange to remove the flange from the plunger body. Do not allow the screwdriver bit to slip off the plunger body in the process, damage to the bore can result. Discard the flange.

**NOTE:** The auto plunger flange is held in place with patch lock and the threads are staked at the factory. It will require approximately 15-20 inch pounds of torque to remove the flange.

5. Remove the plunger body from the spring pin and discard. It may be necessary to tap the plunger body to remove it from the spring pin. Use of a 1/8" pin punch is recommended.

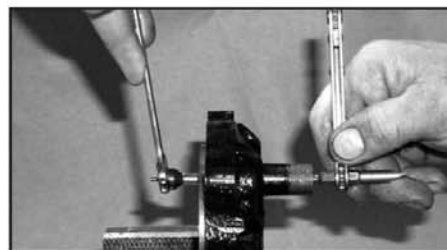
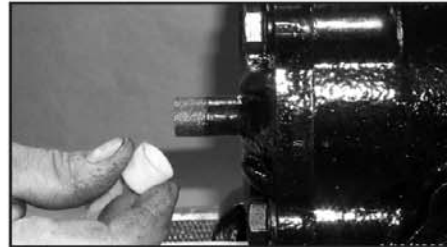

6. Coat the O-ring of the plunger assembly with a light coat of grease and install the plunger body through the spring pin.

**IMPORTANT:** Check the plunger bore for nicks or gouges before installing the plunger assembly. Take care not to introduce dirt or contaminants in the plunger bore when reassembling.

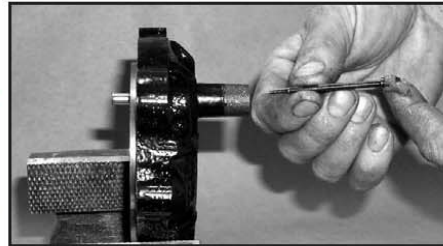

7. Use the screwdriver bit and ratchet to hold the plunger body. Screw the flange onto the plunger body using the 10mm open end wrench until the flange contacts the spring pin.

**NOTE:** The plunger body has patch lock on the threads and will require approximately 15 to 20 inch pounds of torque to overcome the patch lock.

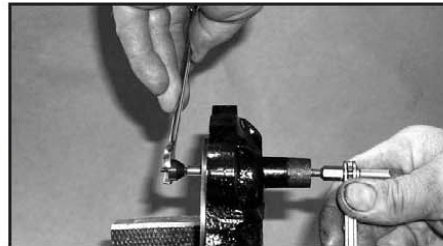

**WARNING** THE FLANGE MUST CONTACT THE SPRING PIN. STEERING GEAR DAMAGE OR A LEAK CAN RESULT.

8. With the flange against the spring pin, use the center punch to stake the threads of the plunger body. Take care to not bend the plunger when staking the threads.

**WARNING** USE EXTREME CAUTION WHEN STAKING THE THREADS OF THE PLUNGER BODY. HITTING THE THREADS TOO HARD WILL BEND THE PLUNGER AND CAUSE STEERING FAILURE

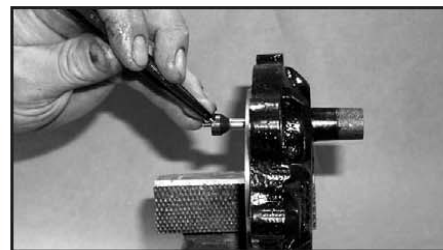

9. Install the cylinder head onto the steering gear taking care to align the marks from disassembly. Torque the attaching bolts to specification. Install the plastic cap over the plunger boss.

10. Fill the reservoir with an approved fluid. Start the engine. Check and correct the fluid level and check for leaks.

11. Set the auto plungers following the procedure in this manual. Lower the hood or cab following the procedures in the vehicle manufacturer's service manual.



## Bearing Cap of Input End Auto Repair

1. Park the vehicle on a clean dry surface (preferably concrete). Set the parking brake and block the wheels. Tilt the hood or raise the cab following the procedures outlined in the vehicle manufacturer's service manual. Identify the steering gear as being equipped with auto plungers. If you have a question on identifying the steering gear, contact the Field Service Department of the R. H. Sheppard Co. at 1-800-274-7437. Place a drain pan under the steering gear.
2. Mark the bearing cap and housing for re-assembly. Remove the universal joint from the input shaft of the steering gear.
3. Remove the plastic plug from the plunger hole and drive the auto plunger in until it bottoms using the 1/4" punch and hammer. Remove the four attaching bolts from the bearing cap using an appropriate size socket and ratchet.

**CAUTION** Failure to keep the 1/4" punch straight in the bore or hitting the plunger too hard can result in damage to the steering gear or auto plunger assembly.

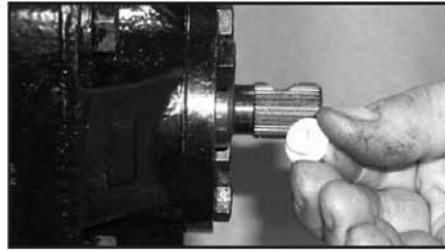

4. Separate the bearing cap assembly from the housing by turning the input shaft out of the housing. Turn the shaft until it stops.

**DANGER** DO NOT FORCE THE SHAFT WHEN TURNING IT OUT OF THE HOUSING. BINDING OF THE SHAFT AND STEERING GEAR DAMAGE CAN RESULT.

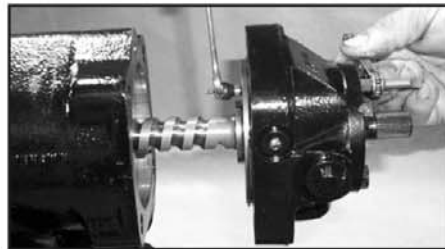

5. Carefully insert the screwdriver bit into the plunger bore to engage the slotted head of the plunger body. Using the 10mm open end wrench to hold the flange across the flat sides, carefully turn the flange from the plunger body. Do not allow the screwdriver bit to slip off the plunger body in the process as damage to the bore can result. Discard the flange.

**NOTE:** The auto plunger flange is held in place with patch lock and the threads are staked at the factory. It will require approximately 15-20 inch pounds of torque to remove the flange.

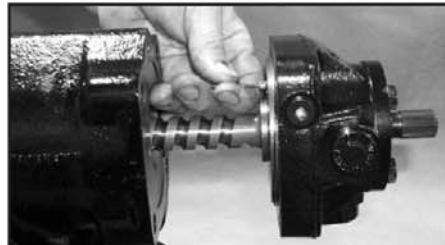

6. Remove the plunger body from the spring pin and discard. It may be necessary to tap the plunger body to remove it from the spring pin. Use of a 1/8" pin punch is recommended.
7. Coat the O-ring of the plunger assembly with a light coat of grease and install the plunger body through the spring pin.

**IMPORTANT:** Check the plunger bore for nicks or gouges before installing the plunger assembly. Take care not to introduce dirt or contaminants in the plunger bore when reassembling.

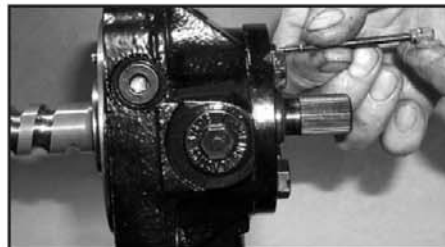



- Use the screwdriver bit and ratchet to hold the plunger body. Screw the flange onto the plunger body using the 10mm open end wrench until the flange contacts the spring pin.

**NOTE:** The plunger body has patch lock on the threads and will require approximately 15-20 inch pounds of torque to overcome the patch lock

**WARNING** THE FLANGE MUST CONTACT THE SPRING PIN. STEERING GEAR DAMAGE OR A LEAK CAN RESULT

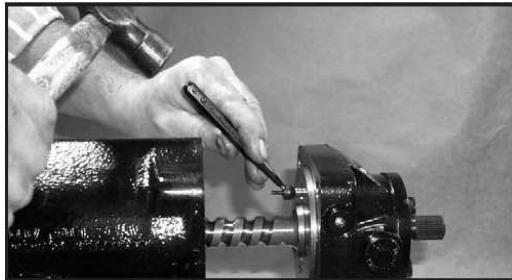

- With the flange against the spring pin, use the center punch to stake the threads of the plunger body. Take care to not bend the plunger when staking the threads.

**DANGER** USE EXTREME CAUTION WHEN STAKING THE THREADS OF THE PLUNGER BODY. HITTING THE THREADS TOO HARD WILL BEND THE PLUNGER AND CAUSE STEERING FAILURE

- Remove the block and install the bearing cap assembly onto the housing taking care to align the reassembly marks made earlier. Install the plug in the plunger hole. Torque the attaching bolts to specifications.
- Install the universal joint onto the steering gear input shaft following the procedures in the vehicle manufacturer's service manual.
- Fill the reservoir with an approved fluid. Start the engine, check and correct the fluid level and check for leaks.
- Set the auto plungers following the procedure in this manual. Lower the hood or cab following the procedures in the vehicle manufacturer's service manual.

## Pitman Arm Removal

It may be necessary to remove the pitman arm on some vehicles before removing the steering gear. Proper technique in removing the pitman arm will avoid damage to the steering gear, pitman arm and retainer.

### TOOLS REQUIRED:

Hammer  
Tapered Punch  
Appropriate Size Allen Drive Socket - 5/8" or 3/4"  
Sheppard Pitman Arm Puller - Kent Moore part number ZTSE4439 or  
Three Jaw Puller  
Impact Wrench

**WARNING** FOR OTHER EQUIPMENT, TOOLS OR SAFETY PROCEDURES ALWAYS FOLLOW THE VEHICLE MANUFACTURER'S PROCEDURES FOR LIFTING AND BLOCKING

**WARNING** THE PITMAN ARM WILL BE EXTREMELY TIGHT. DO NOT USE A HAMMER OR APPLY HEAT TO THE ARM. DAMAGE TO THE SECTOR SHAFT, PITMAN ARM OR SEALS CAN RESULT.

1. Park the vehicle, set the parking brake and raise the hood or cab.



2. Use the punch to bend the restraining tabs out of the pitman arm retainer.



**IMPORTANT:** Do Not bend the aligning tabs out of the pitman arm.

3. Lubricate the face of the retainer with clean chassis lube.

**IMPORTANT:** Failure to lubricate the face of the retainer will cause difficulty in removing the pitman arm.



4. Slide the pitman arm puller over the pitman arm as shown. Take care to align the hole in the puller with the Allen socket in the retainer. Insert the Allen drive socket through the puller and into the retainer socket. Use an impact wrench to back off the retainer. The retainer will act as a jack screw to remove the pitman arm.



**NOTE:** It will be necessary to remove the sector shaft cover bolts to slide the puller over the arm if the gear you are working on has a bolt on cover.

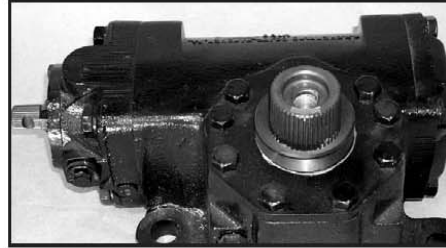

**⚠ DANGER** THE PITMAN ARM WILL BE EXTREMELY TIGHT DO NOT POUND ON THE ARM OR APPLY ANY SOURCE OF HEAT TO THE ARM! DAMAGE TO THE PITMAN ARM OR SECTOR SHAFT CAN CAUSE AN ACCIDENT AT A LATER DATE. NEVER WELD THE PITMAN ARM OR SECTOR SHAFT!



## Pitman Arm Installation

Proper pitman arm installation is critical to the safe operation of the vehicle. Correct torque values are very important! Always follow these procedures when installing the pitman arm.

**⚠ DANGER** IF THE PITMAN ARM IS NOT APPLIED TO THE PROPER SPECIFICATIONS IT CAN COME LOOSE AND CAUSE AN ACCIDENT. ANYTIME A PITMAN ARM IS FOUND LOOSE REPLACE THE PITMAN ARM AND THE SECTOR SHAFT.

### TOOLS REQUIRED:

Appropriate Size Allen Drive Bit  
Torque Wrench  
Hammer  
Punch  
Anti-Seize Compound

**NOTE:** Mount the steering gear on the frame to make pitman arm installation easier

### Procedure:

1. Install the pitman arm onto the sector shaft taking care to align the timing marks.

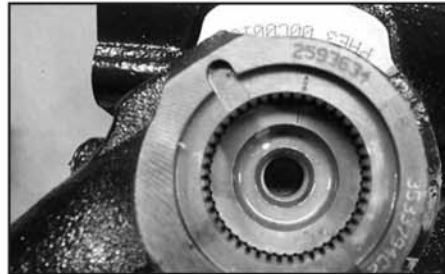

2. Install the pitman arm retainer into the sector shaft. Take care to align the tabs in the notches of the arm. Coat the threads of the retainer with Anti-Seize compound. A Coating of Anti-Seize should be applied to both sides of the friction washer if a new retainer is being used.



**IMPORTANT:** Take note of the torque value on the face of the retainer. Always torque the retainer to the specified value.

M100 - 350 Foot Pounds  
M110 - 450 Foot Pounds  
M80 - 225 Foot Pounds

- Torque the retainer to the specified value using the appropriate size Allen drive bit.

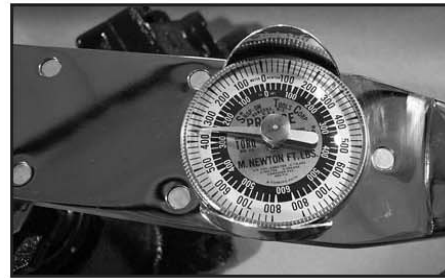

- Continue torquing the retainer past the specified value until two of the notches in the retainer align with the tabs of the washer.

**⚠ DANGER** DANGER DO NOT BACK OFF THE TORQUE VALUE TO ALIGN THE TABS! A LOOSE PITMAN ARM OR LOSS OF STEERING CONTROL COULD RESULT.



- Use the punch and hammer to bend the restraining tabs of the washer into the notches of the retainer. Apply torque putty to the tabs for future reference.

**⚠ DANGER** ONCE THE RETAINER IS TORQUED TO SPECIFICATIONS AND LOCKED IN PLACE, DO NOT RE-TORQUE THE RETAINER. CONSTANT TORQUING OF THE RETAINER CAN CAUSE A LOOSE PITMAN ARM OR LOSS OF STEERING CONTROL.

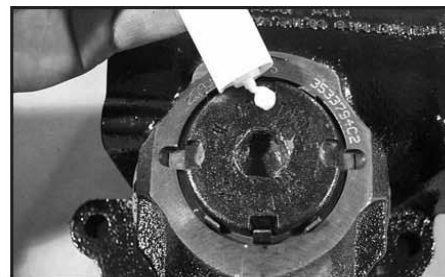
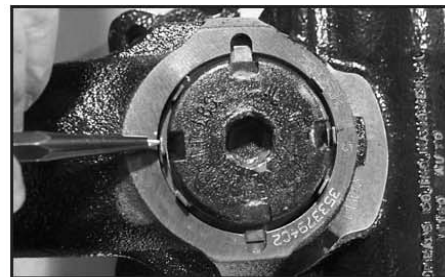

## M110P2 Input Shaft Seal Replacement

Remove the steering gear and disassemble per the instructions for disassembly in this manual.

### TOOLS REQUIRED:

Assorted Sockets  
 Sharp Chisel  
 Hammer  
 Small Bladed Screwdriver  
 Bench Vise

### PROCEDURE:

1. Clamp the bearing cap and shaft assembly in the vise with the ball thread facing up. Remove the relief plunger using the screwdriver.



2. Use the chisel and hammer to split the star nut at the grooves of the adjusting nut. Remove and discard the star nut.

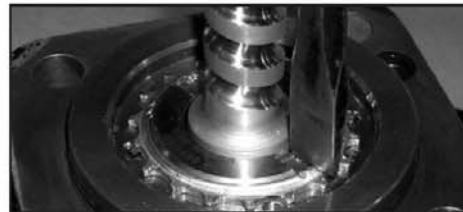

**NOTE:** Use care when splitting the star nut to avoid damaging the adjusting nut.

3. Using a spanner wrench remove the shaft retaining nut from the bearing cap.



4. Carefully remove the valve shaft from the bearing cap. Do not turn the shaft during removal as seal damage could result.



**IMPORTANT:** Do not remove the rotary valve seals!

5. Remove the inner thrust assembly from the valve shaft. Note the order of the thrust assembly for reassembly.



6. Remove the outer thrust assembly from the bearing cap bore. Note the order of assembly for reassembly.

**IMPORTANT:** Do not remove the rotary valve seals!



7. Place the bearing cap on a clean work surface. Remove the outer salt seal.



8. Using an appropriate size seal driver, push the oil seal out of the bearing cap.

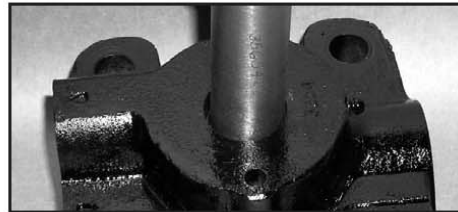

9. Using an appropriate size seal driver, install the oil seal from the inside. Use of an arbor press is recommended. A light coat of lubrication should be applied to the outside diameter of the oil seal. The lip of the seal should face the inside of the bearing cap. The garter spring of the seal will be visible when properly installed.



10. Press the salt seal into the bearing cap until it is flush with the face of the cap. Coat both seals with clean grease before installing the rotary valve shaft.



11. Tape the input shaft splines to prevent seal damage. Place the outer thrust assembly on the rotary valve. The thrust bearing will go toward the valve, the thrust washer will ride on the bearing cap surface.

**NOTE:** Apply a light coat of clean grease to the thrust assembly to hold it in place during assembly.



12. Carefully install the rotary valve shaft into the bearing cap. Do not damage the input shaft oil seal when installing the valve assembly. Do not turn the shaft during installation. Remove the tape from the splines.



13. Install the inner thrust assembly onto the rotary valve shaft. The thrust bearing will ride on the face of the valve and the thrust washer will ride against the shaft retaining nut.



14. Install the shaft retaining nut until it contacts the thrust assembly. Tighten the shaft retaining nut to pre-load the thrust assembly. When properly set, the shaft will turn freely without end play.



**NOTE:** Valve pre-load can be measured by turning the input shaft with an inch pound torque wrench. When properly set the radial drag will not exceed 25 inch pounds.

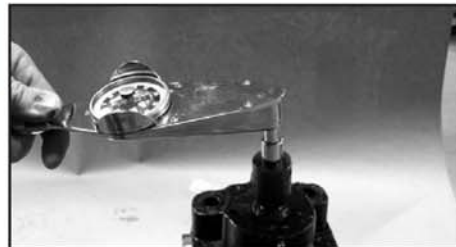



15. Install the locking nut over the shaft retaining nut. Using a spanner wrench tighten the locking nut until two tangs align with the oil flow holes of the bearing cap. Bend the locking tabs into the holes to secure the locking nut.

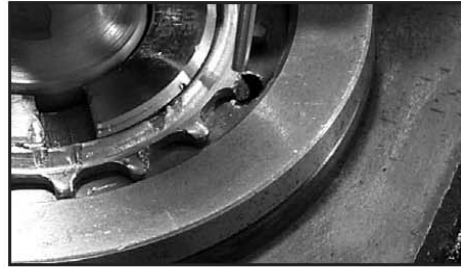

**CAUTION** Do not bend the locking tabs into the threaded plunger hole in the bearing cap.

16. Stake the flange of the locking nut into the slots of the shaft retaining nut. Take care when staking to not break the flange.



17. Install a new O-ring and tetra-seal in the bearing cap. Coat both seals with clean grease for installation. Install the boot over the input shaft splines.



18. Install the plunger into the bearing cap. Reassemble the steering gear following the procedures in the re-assembly portion of this manual.

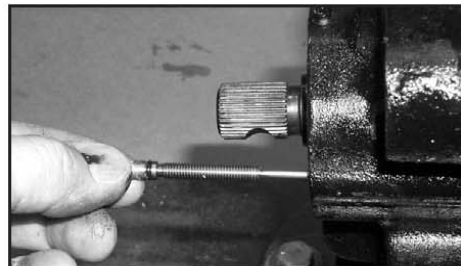

**IMPORTANT:** If your steering gear was originally built with a grease fitting in the bearing cap, remove the fitting and fill the hole with RTV to prevent ingestion of contaminants. No further lubrication is required.



## Disassembly

Complete disassembly of the steering gear is not recommended as a normal repair practice. The Sheppard M-Series gears are designed to be serviced without removing the steering gear from the chassis. Before removing the steering gear from the chassis, you must verify that hydraulic supply performance and system operation are within specification.

**IMPORTANT:** The Sheppard M-Series steering gear is a precision machined component. Care must be taken to keep it free from dirt and foreign material. All internal parts should be handled carefully to avoid damage to machined surfaces. Repairs should not be completed on a hard surface bench to avoid nicks or burrs which can cause damage to mating parts. Remove all nicks and burrs with a fine grit hand stone before assembling.

1. Remove the pitman arm following the instructions in the Pitman Arm Removal section found in the Common Procedures portion of this manual



2. Remove all external seals from the steering gear, including the sector shaft dust boot, snap ring protective cover (if equipped), frame side protective disk and the input shaft dust boot.



Discard all outer protective seals.



3. Mark the end caps for reassembly.



4. Remove the sector shaft cover using the appropriate tools for the steering gear you are working on. There are three methods of attachment for the sector shaft cover. Snap ring design, bolt on or clip style as shown.



Bolt On Cover

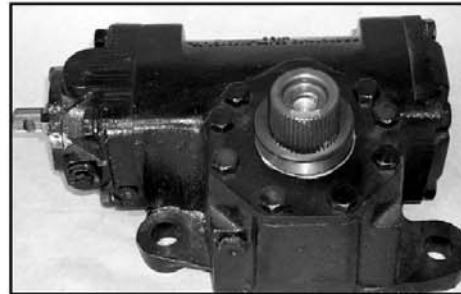

Clip Style Cover

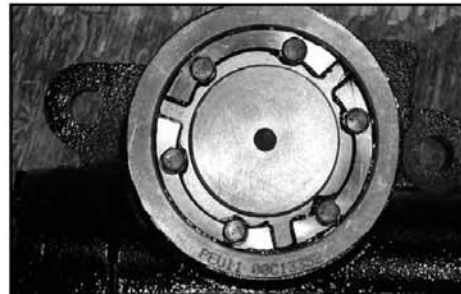

5. Using a soft hammer, remove the sector shaft and cover by tapping on the end of the sector shaft. The sector shaft and cover will come out together.



6. Carefully separate the sector shaft and cover.



- Remove the sector shaft oil seal from the cover using a blunt seal pick. Discard the oil seal. Remove and discard the cover O-ring.

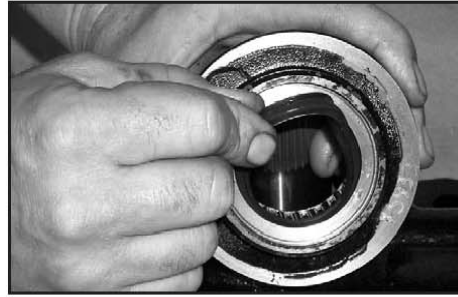

- Remove the excluder seal from the sector shaft cover using a screwdriver.

**NOTE:** Take care when removing the excluder seal. Do not damage the seal bore with the screwdriver.

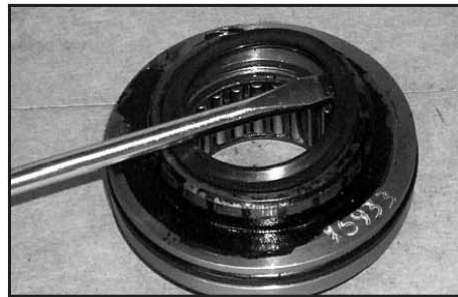

- Remove the four attaching bolts from the bearing cap and turn the input shaft to free the bearing cap assembly from the housing. Turn the shaft until the plunger clears the piston.

**CAUTION** Do not attempt to turn the shaft out of the piston. The re-circulating balls must be removed before the shaft can be removed. Shaft damage will occur if it is forced out of the piston!

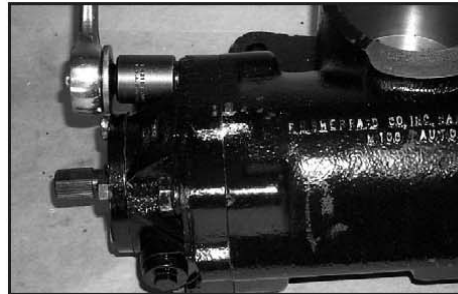

- Carefully slide the piston and bearing cap assembly out of the housing to locate the ball guide retainer.

**IMPORTANT:** It may be necessary to rotate the piston to locate the ball guide retainer.



**CAUTION** The ball guide retainer must be held in place when sliding the piston out of the housing. Re-circulating balls can be lost if the retainer is not held in place.



11. With the piston in the housing and the ball guide retainer visible, screw a #8 x 1.5" sheet metal screw into the hole in the ball guide retainer.

**CAUTION** Do not crack the ball guide retainer during this operation.

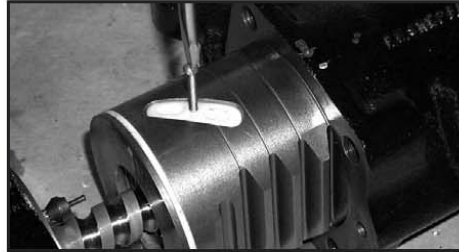

12. Using a pair of pliers on the head of the screw, carefully pry the ball guide retainer out of the piston.



13. Remove the ball return tubes from the piston. Take care not to lose any of the re-circulating balls when removing the ball return tubes.

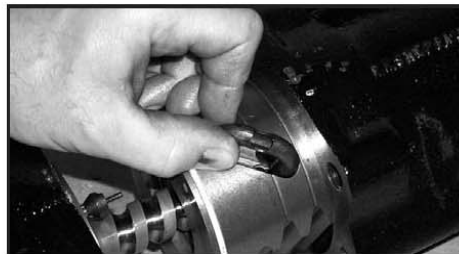

14. Carefully turn the shaft to remove the re-circulating balls from the piston. All M-Series steering gears will have 24 balls. Verify that all balls are removed before removing the valve shaft from the piston.



15. Remove the bearing cap and shaft assembly from the piston. Place the bearing cap and shaft assembly on a clean work surface. If equipped with manual plungers, remove the plunger at this time. Follow the Auto Plunger Repair procedure in the Common Procedures section for Auto Plunger equipped steering gears.

**IMPORTANT:** Do not force the shaft. The shaft will slide freely from the piston if all 24 balls are removed.

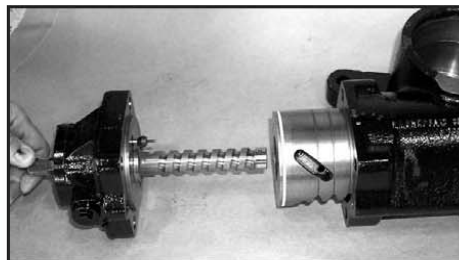

**CAUTION** Do Not Disassemble the bearing cap and shaft assembly. There are no serviceable parts in this assembly. Only the input shaft seal is serviceable! Refer to Input Shaft Seal Replacement in "Common Procedures" section.

- Carefully slide the piston out of the housing. Piston to housing clearance is very tight. Do not force the piston to remove it. Place the piston on a clean work surface. Remove the Teflon piston ring and energizing O-ring from the piston.

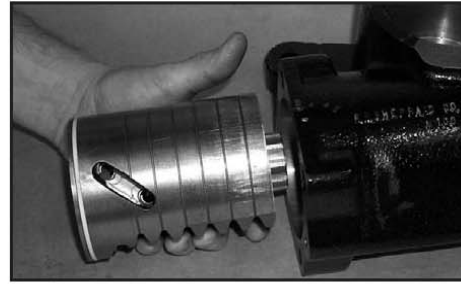

- Remove the seal ring and tetra-seal from the bearing cap and shaft assembly.

**IMPORTANT:** Do not disassemble the bearing cap and shaft assembly.

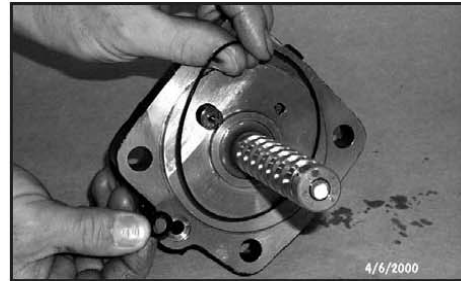

- Remove the cylinder head from the housing. Remove the seal ring and tetra-seal and discard. If equipped with manual plungers, remove the plunger at this time. Follow the Auto Plunger Repair procedure in the Common Procedures section for Auto Plunger equipped steering gears.



- Remove the sector shaft oil seal from the housing.

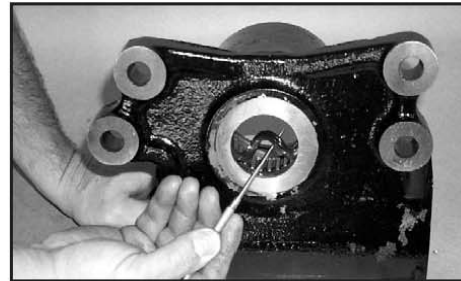

- Disassembly of the steering gear is complete.

**IMPORTANT:** Do not disassemble the bearing cap and shaft assembly.

**IMPORTANT:** Do not remove the piston plug from the piston.



## Sub Assemblies

### M-SERIES OPTIONAL INTEGRAL RELIEF VALVE

An optional integral pressure relief valve is offered with the Sheppard M-Series steering gear. The relief valve cartridge is located in the bearing cap. The valve limits the maximum operating pressure in the steering system. In most cases, the hydraulic supply pump will have a maximum relief pressure setting higher than the integral relief valve in the steering gear.

When maximum relief pressures are reached in the steering system, the excess pressure is relieved within the steering gear.

When oil pressure exceeds the maximum relief pressure setting of the pilot-operated relief valve, the valve opens. Excess pressure is bled off into the oil return circuit through the return port of the steering gear.

The relief valve cartridge can be removed for cleaning and inspection. Remove the relief valve nut and cartridge assembly. At this time the strainer can also be cleaned and inspected.

NOTE: The relief valve cartridge can not be disassembled and must be replaced if bad.

The O-rings and strainer are replaceable and are included as part of the complete seal kit.

**CAUTION** Never use old seals or O-rings. Use the complete seal kit.

To install the relief valve cartridge in the bearing cap, insert the cartridge assembly into the relief valve bore and torque the valve nut to 35 ft./lbs.

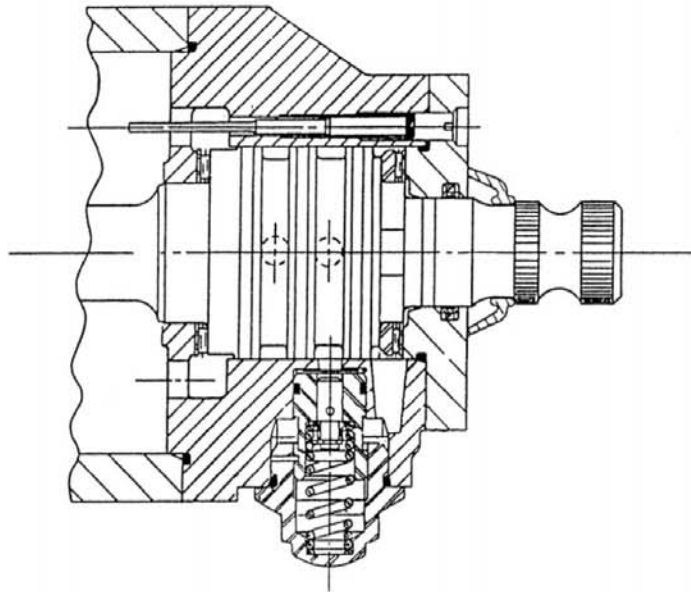

# Reassembly

REASSEMBLY

## CLEANING & INSPECTION

### Cleaning

Cleanliness is important. Dirt and foreign material that gets into the steering system during repair operations can cause damage or a possible steering malfunction at a later date. Due to the close tolerances between mating parts it is best to have all parts at the same temperature for reassembly.

Clean the machined parts individually to avoid damage caused by “bumping” together. Use clean solvent to wash parts. Dry the parts with compressed air. Nicks or burrs must be removed with a fine hand stone before assembly. Use clean lubricant to coat parts for assembly. All hoses, lines and the reservoir should be cleaned before reinstalling a repaired steering gear or after pump replacement. Replace the filter element or cartridge.

### Inspection

Make a careful visual inspection of all steering gear parts. Replace worn parts as well as any parts that show signs of stress or fatigue.

**! DANGER** STEERING GEARS THAT HAVE BEEN DAMAGED IN AN ACCIDENT MUST BE REPLACED. IMPACT LOADS TRANSMITTED THROUGH THE FRONT AXLE AND STEERING LINKAGE INTO THE STEERING GEAR CAN STRESS PARTS TO A POINT JUST SHORT OF FAILURE. FURTHER USE IS UNSAFE AND THE STEERING GEAR ASSEMBLY AND PITMAN ARM MUST BE REPLACED. DISTORTED PITMAN ARMS, TWISTED SECTOR SHAFTS, BROKEN OR CRACKED RACK AND PINION GEAR TEETH ARE SOME SIGNS OF IMPACT DAMAGE. BROKEN OR DAMAGED MOUNTING BRACKETS MUST BE REPLACED.

Steering gear parts inspection may show problems in other areas of the steering system. To avoid repeat problems inspect all parts carefully. Listed below are the more common problems you may see during steering gear inspection along with their possible cause. This information should be considered carefully when repairing low mileage vehicles. Remember it is more important to repair the cause than the results.

<b>Parts Discolored (blue)</b>	<ol style="list-style-type: none"> <li>1. Operating temperatures too high</li> <li>2. Steering column binding</li> <li>3. Hydraulic supply pump malfunctioning</li> </ol>	<b>Broken Housing</b>	<ol style="list-style-type: none"> <li>1. Accident damaged</li> </ol>
<b>Sector Shaft (Roller bearing wear)</b>	<ol style="list-style-type: none"> <li>1. Incorrect lubricant use</li> <li>2. Excessive temperature</li> <li>3. Overloading the axle</li> <li>4. Contaminated lubricant</li> <li>5. Impact damage</li> </ol>	<b>Housing or Piston Scoring (Also see following NOTE)</b>	<ol style="list-style-type: none"> <li>1. Foreign material entry</li> <li>2. Severe overloading</li> <li>3. Incorrect lubricant used</li> <li>4. Excessive temperature (over 250)</li> <li>5. Pump damaged</li> </ol>
<b>Actuating Shaft (ball thread brinelled or dented)</b>	<ol style="list-style-type: none"> <li>1. Impact damages</li> </ol>	<b>Thrust Bearings (pitted, rough)</b>	<ol style="list-style-type: none"> <li>1. Foreign material in system</li> <li>2. Excessive overloading</li> </ol>
<b>Actuating Shaft (thread wear)</b>	<ol style="list-style-type: none"> <li>1. Incorrect lubricant used</li> <li>2. Overloading</li> <li>3. Insufficient operating pressure</li> <li>4. Insufficient oil flow</li> <li>5. Continued operation at high temperature</li> </ol>	<b>Thrust Bearings (broken or distorted)</b>	<ol style="list-style-type: none"> <li>1. Impact damage</li> <li>2. Incorrect repairs</li> </ol>
		<b>Piston Rings (cut, pinched, sheared or worn)</b>	<ol style="list-style-type: none"> <li>1. Incorrect installation</li> <li>2. Incorrect assembly</li> </ol>

### Note on scoring

Minor scoring and scuffing of the piston and housing of the steering gear is normal. During operation at relatively high pressure and flow rates this minor scoring will not affect the safety or operation of the steering gear. Minor scoring should be polished with a fine hand stone or crocus cloth.

**! CAUTION** The cylinder bore should not be honed or bored out. This will increase internal leakage.



## Reassembly

1. Install a new seal on the piston by first installing the O-ring in the groove then carefully installing the Teflon piston seal over the O-ring. The Teflon seal will stretch as it is fitted over the piston. Take care not to tear the Teflon when installing. Use a ring compressor on the Teflon seal to aid in the installation into the housing.



2. Install a new sector shaft oil seal in the housing. When properly fitted the seal will ride between the roller bearing and housing lip. The black lip of the seal must face the bearing.



**IMPORTANT:** The sector shaft seal is a two piece seal. It will necessary to bend the seal for installation. Once the seal is installed you may have to work the seal into place with your fingers or a blunt seal pick to properly seat the seal. Press only on the body of the seal.

**DO NOT PRESS ON THE LIP OF THE SEAL!**

3. Install the piston into the steering gear housing. Refer to the marks made at disassembly to insure you are installing the piston in the correct end of the housing.

**NOTE:** The housing will have a lead in chamfer on one end for piston installation. Piston to housing clearance is very close. Do not force the piston when installing. Housing damage can result.

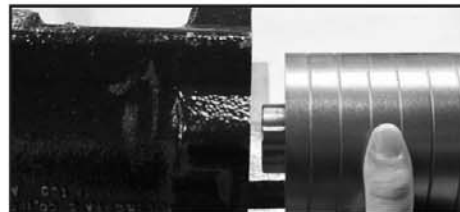

4. Rotate the piston so the ball guide cavity is visible and accessible as shown.

**NOTE:** The rack gear of the piston may not be in the proper position for assembly during this process.

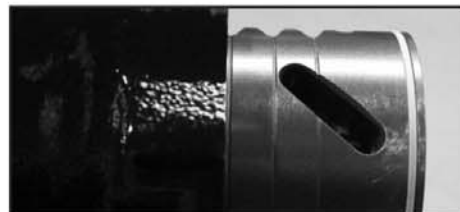

5. Install a new seal ring and tetra-seal on the bearing cap assembly.

**NOTE:** If you are working on an *Auto Plunger* equipped gear, make sure you have completed the repair procedure outlined in the *Auto Plunger Repair* section of this manual.



6. Insert the valve shaft into the ball thread of the piston.  
Align the threads of the valve shaft with the holes in the ball guide cavity.

**NOTE:** When properly positioned in the piston one thread of the valve shaft will be visible through each of the ball feed holes in the piston.

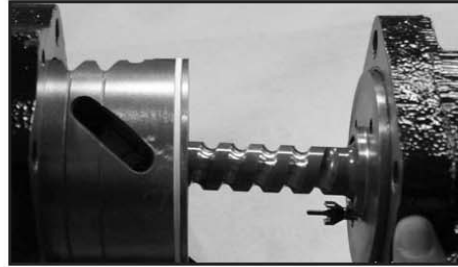

7. Support the bearing cap and shaft assembly with your hand. Install the re-circulating balls, one at a time, into the ball guide feed hole closest to the end of the piston.

**CAUTION** Do not allow the re-circulating balls to drop into the rearward hole or feed balls through both holes. Steering gear lock up can result!

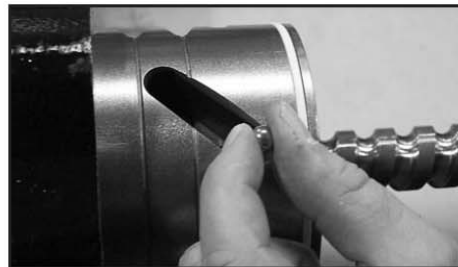

8. Slowly turn the input shaft into the piston while feeding the balls into the ball guide feed hole. As you feed the balls you will feel the shaft being supported as the balls fill the threads.

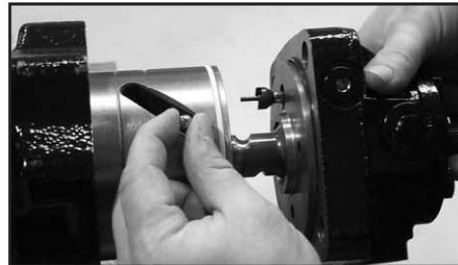

9. Continue to feed the balls until the balls are visible in the rearward hole of the ball guide cavity.

**NOTE:** Approximately 16 balls will have been installed when they become visible in the rearward hole of the ball guide cavity.

**CAUTION** Do not back off the shaft during ball installation. Binding or shaft damage can result.



10. Hold the shaft assembly stationary and install both halves of the ball return tube. Continue feeding the balls through the access hole in the ball return tubes until 24 balls have been installed.

**NOTE:** Twenty four balls must be installed for proper operation.



11. Replace the O-ring on the ball guide retainer and install the ball guide retainer over the ball return tubes.

**IMPORTANT:** When properly installed the ball guide retainer will be flush with the contour of the piston.

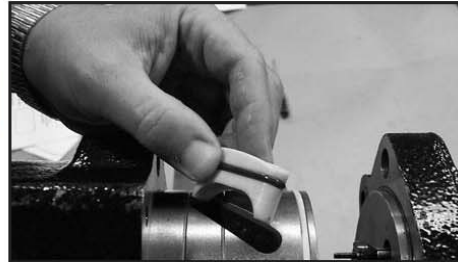

12. Slide the piston into the housing until the ball guide retainer is secured by the housing. Locate the rack gear of the piston with the opening in the housing at this point.



13. Slide the piston into the housing until the rack gear is centered in the sector shaft bore of the housing. Locate the timing marks on the piston rack for reference.

**WARNING** TAKE CARE WHEN INSTALLING THE PISTON INTO THE HOUSING. DO NOT PINCH OR TEAR THE PISTON RING DURING INSTALLATION.



14. Align the marks on the bearing cap with the marks on the housing. Install the four attaching bolts in the bearing cap assembly and torque to specifications.

**IMPORTANT:** Some M-Series steering gears use different length bolts in the bearing cap attachment. Make sure the bolts do not bottom out when installed.



15. Install the sector shaft by carefully aligning the timing mark of the sector shaft with the two timing marks of the rack piston. It will be necessary to tap the sector shaft into place with a soft hammer to ensure full rack engagement.

**IMPORTANT:** Coat the end of the sector shaft with clean chassis grease to prevent seal damage at installation.

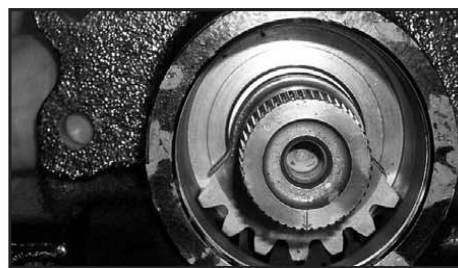

16. Install a new sector shaft oil seal in the sector shaft cover. When properly fitted the seal will ride between the roller bearing and cover. The black lip of the seal must face the bearing.

**IMPORTANT:** The sector shaft seal is a two piece seal. It will necessary to bend the seal for installation. Once the seal is installed you may have to work the seal into place with your fingers or a blunt seal pick to properly seat the seal. Press only on the body of the seal. **DO NOT PRESS ON THE LIP OF THE SEAL!**

**NOTE:** There are three styles of sector shaft covers used on Sheppard M-Series steering gears. Seal installation is the same for all cover styles.

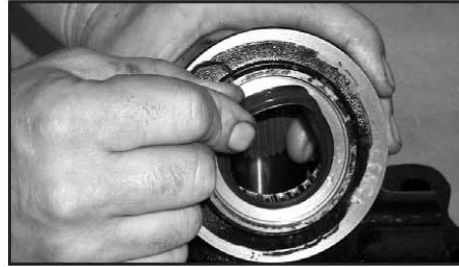

17. Install the sector shaft cover onto the steering gear. It may be necessary to drive the cover on with a dead blow hammer. Attach the cover using the appropriate tools for the steering gear you are working on.

**IMPORTANT:** Coat the seal area of the sector shaft with grease to prevent seal damage at installation.



**CAUTION** When installing a snap ring or clip style cover, the cover must be flush or below the groove in the housing. Improper installation can result in separation of the cover without warning. Personal injury or an accident can result.



**VARIATION:** Some Sheppard M-Series steering gears may have a closed end sector shaft cover. When installing a closed end cover, be sure to install the protective plug in the cover after installation.

If your closed end cover has a vent hole, make sure the vent hole is open before installation of the cover. After the cover is installed, plug the vent hole with an RTV compound to avoid ingestion of contaminants.

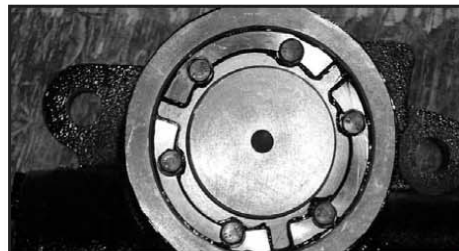

18. Install a new seal ring and tetra-seal on the cylinder head end cap. Install the cylinder head onto the housing, taking care to align the marks made at disassembly. Torque the attaching bolts to specifications.

**NOTE:** If you are working on an Auto Plunger equipped gear, make sure you have completed the repair procedure outlined in the Auto Plunger Repair section of this manual.

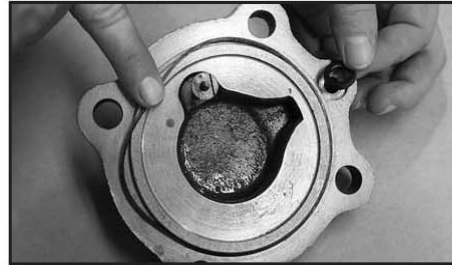

19. Replace the O-rings on manually adjustable plungers and install them into the end caps.

**IMPORTANT:** The longer plunger will be installed in the bearing cap end of the steering gear.



20. Install the excluder seal in the sector shaft cover using a 2.25" seal driver. Pack the lip of the excluder seal with clean chassis grease before installing. When properly installed the lip of the excluder will face outward and the seal will bottom in the excluder seal groove.

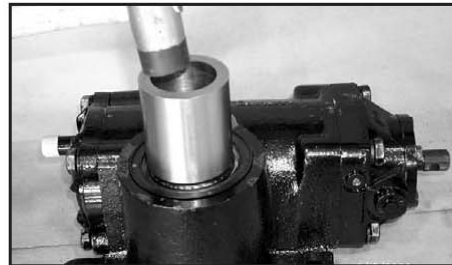

21. Install the frame side dust cover on housing. Thoroughly clean the housing with a suitable solvent and apply a bead of RTV on the edge of the disk to secure it to the housing. Allow adequate time for the RTV to set.



22. Install the snap ring protective cover in the sector shaft cover bore over the snap-ring by lightly tapping on the outside diameter. Install the slide on V-boot over the sector shaft. Install the rubber boot on the input shaft.

The steering gear may now be installed on the vehicle. Refer to the Common Procedures section for pitman arm installation, relief plunger adjustment and bleeding procedures

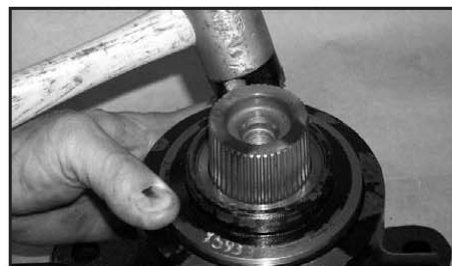

## Dual Steering Gear Systems

Two or more integral steering gears are sometimes used where front axle weights exceed 16,000lbs gross front axle weight rating. Dual steering systems are used to balance the steering gear output across two or more steering arms and conserve under hood space.

The secondary or slave unit is mounted on the right hand side of the vehicle and operates off of pressure supplied by the master or left hand steering gear. Dual steering systems are mechanically linked to the front end components by a drag link and steer arm on the right hand spindle on the axle. No physical link exists between the master and slave. Hydraulic pressure and flow reacting on the slave gear piston causes the slave gear to operate under pressure in the opposite direction of the master gear assisting in the power steering operation of the system. Hydraulic relief plungers are not used in the slave gear. Master gear relief plungers will relieve hydraulic pressure for both gears when properly adjusted.

There are three dual system configurations common with the Sheppard M-Series steering gears M-Series Cooling Slave, M-Series Standard Slave and 92 series slave gears. Operation of the slave is consistent no matter which slave configuration you are working with.

Dual systems can be plumbed one of two ways depending on slave gear configuration. Typical plumbing configurations are:

**M-Series Cooling Slave** - Cooling slaves have a low pressure return port cast along the length of the slave gear housing. Return oil from the master gear is routed through this port and back to the reservoir. The additional line provides a cooling effect as well as using the slave gear as a heat sink.

**92 Series Slave Gear** - Return oil is routed from the return side of the master gear through the sector shaft bore of the 92 series slave then back to the reservoir. The additional line provides a cooling effect as well as using the slave gear as a heat sink. Refer to page 63 for diagram

**M-series Standard Slave** - Requires only the cross over pressure lines between the master gear and the slave steering gear. No additional line is required in the plumbing of the standard slave dual system. Refer to page 62 for diagram

**NOTE:** The Sheppard M-Series steering gear may also be used with an assist cylinder. Refer to your truck manufacturer's service manual for operation, bleeding and repair procedures for hydraulic assist cylinders.

**IMPORTANT:** Bleeding of the dual system is critical whenever the oil has been changed, the system has been opened to atmosphere or a steering gear has been replaced. Follow the Dual System Bleed procedure in the Common Procedures section of this manual.

Standard Slave System

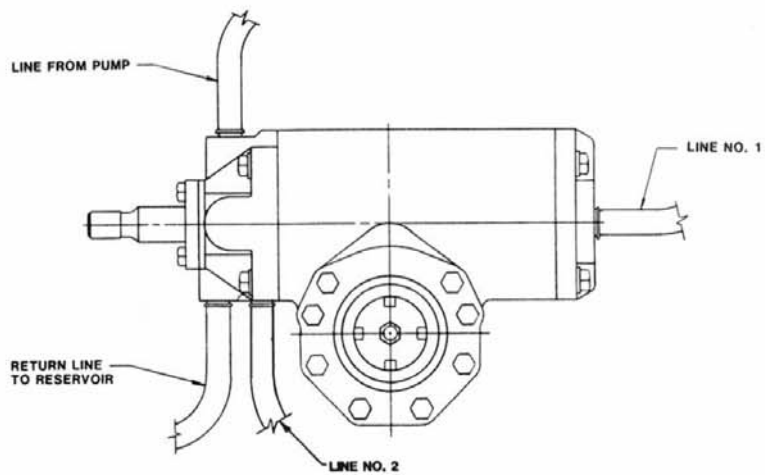
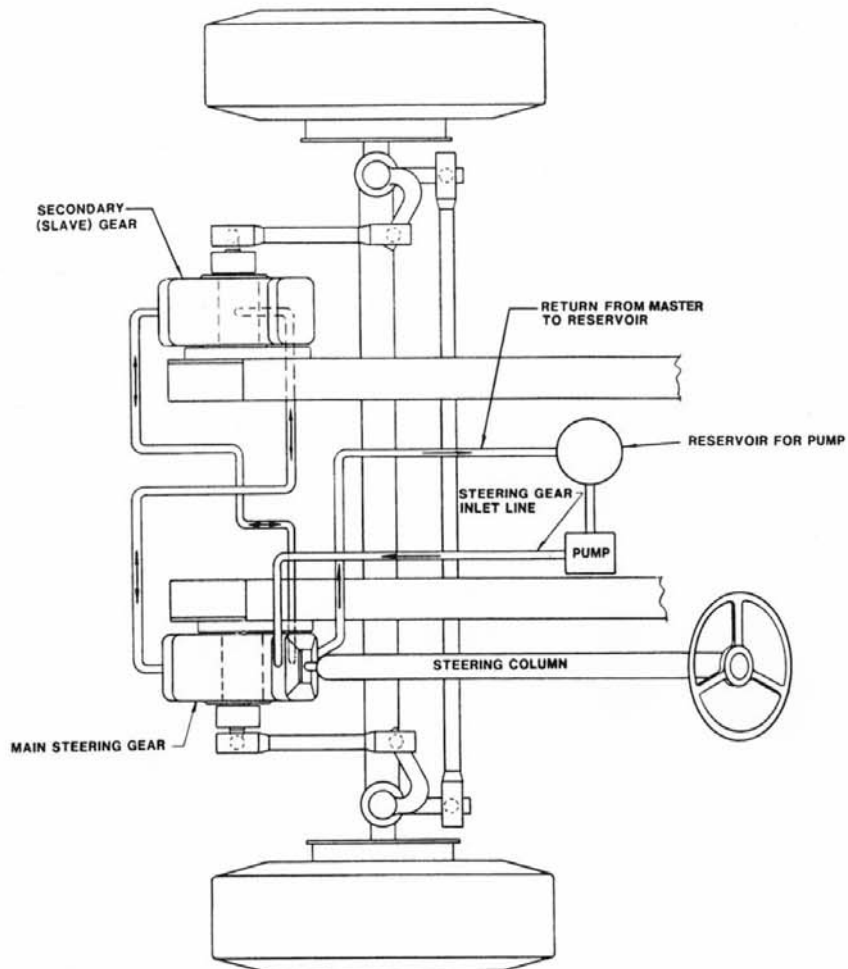

Cooling Slave System

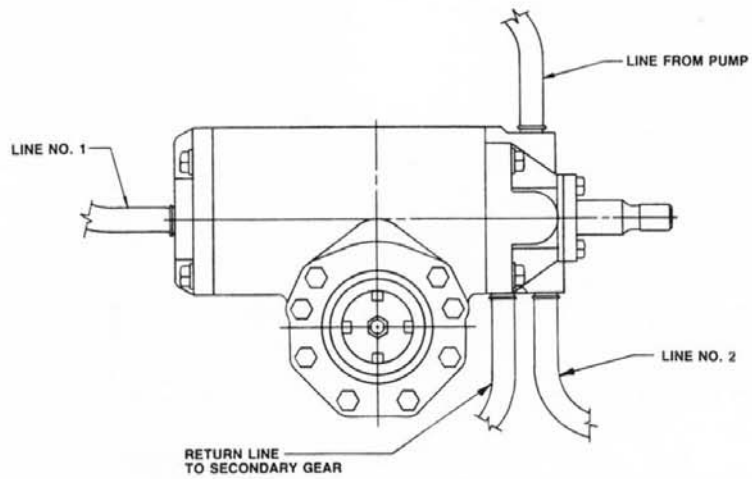
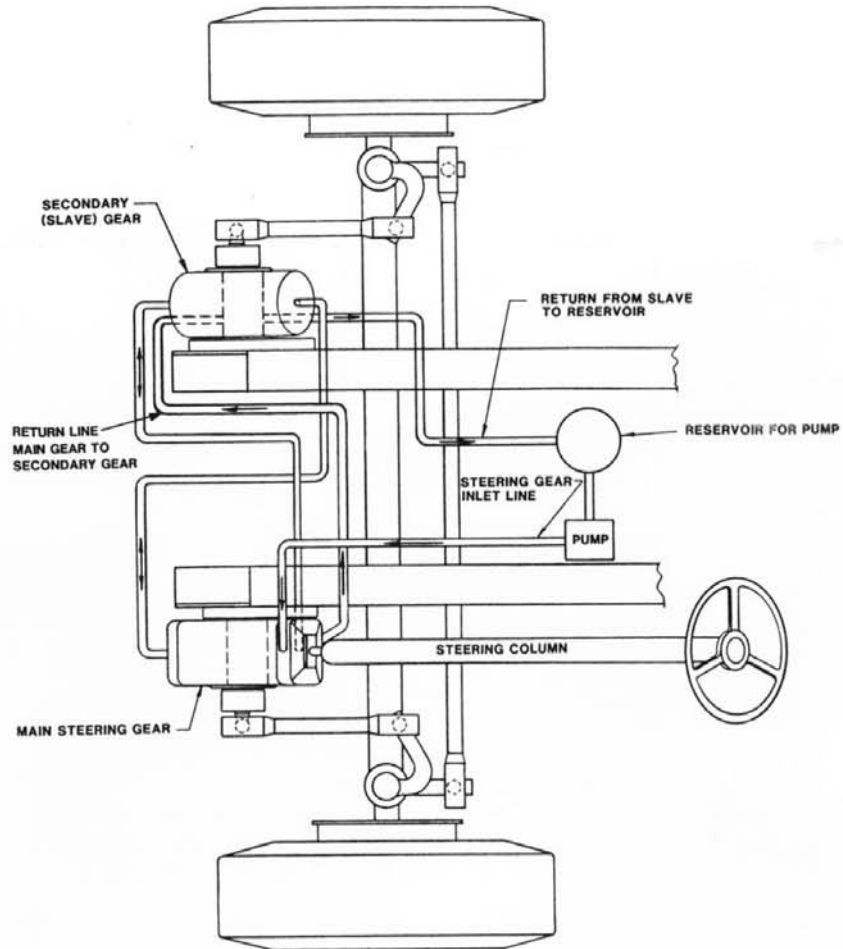



## M-Series Slave Gears - Cooling Slave & Standard Slave

The Sheppard M-Series slave gear is simple in operation and should not require disassembly for repair.

Sheppard M-Series slave gears contain only two moving parts, a power piston and a sector shaft. Repairs can be completed, if necessary, by following the procedures in the disassembly & reassembly sections of this manual. Keep in mind that slave steering gears do not have input shafts or relief plungers should you have a need for disassembly.

Typical M-Series Cooling Slave Gear



Typical M-Series Standard Slave Gear



Typical 92 Series Slave Gear

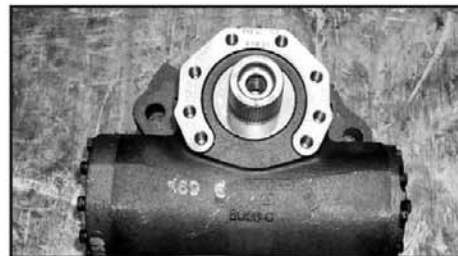

Disassembled Slave Steering Gear - M-Series.

Refer to **Sheppard Service Manual 1000485** for 92 Series Slave repairs.



## Final Adjustments

Sheppard Power Steering gears have no external adjustments for sector shaft or valve shaft pre-load. Make sure all linkages and system components are within vehicle manufacturers specs.

**TORQUE:** Check all fastener torques when installing the steering gear. A torque chart for steering gear fasteners can be found in the chart below. Consult the vehicle manufacturers service manual for steering gear to frame, pinch bolt and drag link torque values.

**PITMAN ARM:** Pitman arm application torque is critical. Follow the pitman arm installation instructions in this manual.

**! DANGER** IMPROPER INSTALLATION OF THE PITMAN ARM COULD LEAD TO AN ACCIDENT OR SERIOUS PERSONAL INJURY!

**SET RELIEF PLUNGERS:** Verify the type of relief plungers in your steering gear. Refer to the Common Procedures section of this manual to properly set the relief plungers.

**BLEED THE SYSTEM:** Follow the guidelines in the Common Procedures Section for proper bleeding of both single and dual gear systems.

### TORQUE SPECIFICATIONS

APPLICATION	SIZE	GRADE	FT/LBS	(Nm)
Bearing Cap Cover - All M-Series	M10 x 1.5	10.9	53-64	(72-87)
Bearing Cap Bolts				
M80	M10 x 1.5	10.9	53-64	(72-87)
M90	M12 x 1.75	8.8	72-87	(97-118)
M100	M14 x 2.0	8.8	114-140	(154-190)
M110	M16 x 2.0	10.9	230-277	(312-376)
Cylinder Head				
M80	M10 x 1.5	10.9	53-64	(72-87)
M90	M12 x 1.75	8.8	72-87	(97-118)
M100	M14 x 2.0	8.8	114-124	(154-190)
M110	M10 x 1.5	10.9	53-64	(72-87)
All Clip Style Cover Bolts	M8 x 1.25	12.9	31-38	(42-52)



**TROUBLESHOOTING CHECKLIST**

Before proceeding with the following tests, be sure to read the diagnosis and Troubleshooting section of this manual. Check all mechanical and external conditions before hydraulic testing.

Date: \_\_\_\_\_

Servicing Dealer Location: \_\_\_\_\_  
\_\_\_\_\_  
\_\_\_\_\_

Customer Name: \_\_\_\_\_

Description of Steering Complaint:  
\_\_\_\_\_  
\_\_\_\_\_  
\_\_\_\_\_

Vehicle Model \_\_\_\_\_ Mileage \_\_\_\_\_ VIN \_\_\_\_\_  
 Steering Gear Model: \_\_\_\_\_ Serial No. \_\_\_\_\_  
 Slave Gear Model (if equipped) \_\_\_\_\_ Serial No. \_\_\_\_\_  
 Pump Manufacturer \_\_\_\_\_ Front Axle Weight \_\_\_\_\_

**Hydraulic Tests:**

Do not remove the steering gear! Install a pressure and flow tester in series with the pressure line of the pump as outlined in the Diagnosis and Troubleshooting Section. Record the following information:

Stabilized Oil Temperature: \_\_\_\_\_  
 System Backpressure @ Idle \_\_\_\_\_ Backpressure @ Full RPM \_\_\_\_\_  
 Maximum System Pressure (Pump Relief Setting) \_\_\_\_\_ psi  
 Flow @ Idle with Backpressure Only ..... GPM  
 Flow @ Full Governed RPM Backpressure Only ..... GPM  
 Flow @ Idle With 1500psi Load Applied ..... GPM  
 Flow @ Full Governed RPM With 1500psi Load Applied .. GPM

Static Steer Pressure    Right Turn \_\_\_\_\_ psi    Left Turn \_\_\_\_\_ psi  
 Static Steer Input            Right Turn \_\_\_\_\_ In. Lbs    Left Turn \_\_\_\_\_ In. Lbs.

If you are unsure of your diagnosis contact Sheppard Field Service at 1-800-274-7437

**R.H. Sheppard Company, Inc.**  
 101 Philadelphia Street, P.O. Box 877 • Hanover, PA 17331-0877 • Tel: 717.637.3751 • Fax: 717.633.4125  
[www.rhsheppard.com](http://www.rhsheppard.com)

RHSCO1202000

## Heavy Duty Power Steering Test Kit

This tester is a self contained, direct reading device to check system flow, pressure or both simultaneously. Requiring no electrical connections, it can detect worn components, verify flow and pressure control settings or monitor overall performance.

**EASY TO USE -**

Only one hose connection is broken, either at the pump output or at the pressure input to the power steering gear housing.

- Installs between pump and steering gear
- Shutoff valve isolates pump from gear
- Pressure and flow can be read simultaneously
- 0-3000 P.S.I. pressure gauge
- 1-10 G.P.M. flow meter
- Complete with hoses & standard swivel fitting



- **SHIPMENT FROM STOCK**
- **INCLUDES SHEPPARD SERVICE MANUAL**

*PHOTOCOPY AND USE FOR ORDER FORM*

CUSTOMER'S ORDER NO.		DATE		OUR ORDER NO.	
SOLD TO:			SHIPPED TO:		
ITEM NO.	QTY ORDERED	PART NUMBER	PART DESCRIPTION	UNIT PRICE	TOTAL
		5517641	Pressure Flow & Test Kit		

Includes Sheppard service manual with operating instructions

**R.H. Sheppard Company, Inc.**  
 101 Philadelphia Street, P.O. Box 877 • Hanover, PA 17331-0877 • Tel: 717.637.3751 • Fax: 717.633.4125  
[www.rhsheppard.com](http://www.rhsheppard.com)