

# ROOTS

*Blowers Compressors Exhausters*

US \$3.00, Canada \$4.50

## Universal RAI<sup>®</sup>, URAI-DSL, URAI-G and Metric Series

### Contents

Information Summary . . . . .	1	Inspection & Maintenance. . . . .	11
Safety Precautions. . . . .	3	Figures. . . . .	12-15
Operating Limitations. . . . .	3	Tables. . . . .	15-16
Installation. . . . .	4	Assembly Drawings. . . . .	17-22
Lubrication. . . . .	8	Parts List. . . . .	23-24
Operation. . . . .	9	Basic Connection & Drive Shaft Information. . . . .	25-27
Troubleshooting. . . . .	10		

### Do These Things To Get The Most From Your ROOTS™ blower

- Check shipment for damage. If found, file claim with carrier and notify Roots.
- Unpack shipment carefully, and check contents against Packing List. Notify Roots if a shortage appears.
- Store in a clean, dry location until ready for installation. Lift by methods discussed under INSTALLATION to avoid straining or distorting the equipment. Keep covers on all openings. Protect against weather and corrosion if outdoor storage is necessary.
- Read OPERATING LIMITATIONS and INSTALLATION sections in this manual and plan the complete installation.
- Provide for adequate safeguards against accidents to persons working on or near the equipment during both installation and operation. See SAFETY PRECAUTIONS.
- Install all equipment correctly. Foundation design must be adequate and piping carefully done. Use recommended accessories for operating protection.
- Make sure both driving and driven equipment is correctly lubricated before start-up. See LUBRICATION.**
- Read starting check points under OPERATION. Run equipment briefly to check for installation errors and make corrections. Follow with a trial run under normal operating conditions.
- In event of trouble during installation or operation, do not attempt repairs of Roots furnished equipment. Notify Roots, giving all nameplate information plus an outline of operating conditions and a description of the trouble. Unauthorized attempts at equipment repair may void Roots warranty.
- Units out of warranty may be repaired or adjusted by the owner. Good inspection and maintenance practices should reduce the need for repairs.

**NOTE:** Information in this manual is correct as of the date of publication. Roots reserves the right to make design or material changes without notice, and without obligation to make similar changes on equipment of prior manufacture.

For your nearest Roots Office, dial our Customer Service Hot Line toll free; 1 877 363 ROOT(S) (7668) or direct 832-590-2600.



---

**ROOTS™ products are sold subject to the  
current General Terms of Sale, GTS-5001  
and Warranty Policy WP-5020. Copies are  
available upon request.**

**Contact your local Roots Office  
or Roots Customer Service**

**Hot Line 1-877-363-ROOT(S) (7668) or  
direct 832-590-2600.**

---

## Safety Precautions

---

It is important that all personnel observe safety precautions to minimize the chances of injury. Among many considerations, the following should be particularly noted:

- Blower casing and associated piping or accessories may become hot enough to cause major skin burns on contact.
- Internal and external rotating parts of the blower and driving equipment can produce serious physical injuries. Do not reach into any opening in the blower while it is operating, or while subject to accidental starting. Protect external moving parts with adequate guards.
- Disconnect power before doing any work, and avoid bypassing or rendering inoperative any safety or protective devices.
- If blower is operated with piping disconnected, place a strong coarse screen over the inlet and avoid standing in the discharge air stream. **CAUTION: Never cover the blower inlet with your hand or other part of body.**
- Stay clear of the blast from pressure relief valves and the suction area of vacuum relief valves.
- Use proper care and good procedures in handling, lifting, installing, operating and maintaining the equipment.
- Casing pressure must not exceed 25 PSI (1725 mbar) gauge. Do not pressurize vented cavities from an external source, nor restrict the vents without first consulting ROOTS.
- Do not use air blowers on explosive or hazardous gases.
- Other potential hazards to safety may also be associated with operation of this equipment. All personnel working in or passing through the area should be trained to exercise adequate general safety precautions.

## Operating Limitations

---

A ROOTS blower or exhauster must be operated within certain approved limiting conditions to enable continued satisfactory performance. Warranty is contingent on such operation.

Maximum limits for pressure, temperature and speed are specified in TABLE 1 for various models & sizes of blowers & exhausters. These limits apply to all units of normal construction, when operated under standard atmospheric conditions. Be sure to arrange connections or taps for instruments, thermometers and pressure or vacuum gauges at or near the inlet and discharge connections of the unit. These, along with a tachometer, will enable periodic checks of operating conditions.

**PRESSURE** – The pressure rise, between inlet and discharge, must not exceed the figure listed for the specific unit frame size concerned. Also, in any system where the unit inlet is at a positive pressure above atmosphere a maximum case rating of 25 PSI gauge (1725 mbar) should not be exceeded without first consulting Roots. Never should the maximum allowable differential pressure be exceeded.

On vacuum service, with the discharge to atmospheric pressure, the inlet suction or vacuum must not be greater than values listed for the specific frame size.

**TEMPERATURE** – Blower & exhauster frame sizes are approved only for installations where the following temperature limitations can be maintained in service:

- Measured temperature rise must not exceed listed values when the inlet is at ambient temperature. Ambient is considered as the general temperature of the space around the unit. This is not outdoor temperature unless the unit is installed outdoors.
- If inlet temperature is higher than ambient, the listed allowable temperature rise values must be reduced by 2/3 of the difference between the actual measured inlet temperature and the ambient temperature.
- The average of the inlet and discharge temperature must not exceed 250°F. (121°C).
- The ambient temperature of the space the blower/motor is installed in should not be higher than 120°F (48.8°C).

**SPEED** – These blowers & exhausters may be operated at speeds up to the maximum listed for the various frame sizes. They may be direct coupled to suitable constant speed drivers if pressure/temperature conditions are also within limits. At low speeds, excessive temperature rise may be a limiting factor.

**Special Note:** The listed maximum allowable temperature rise for any particular blower & exhauster may occur well before its maximum pressure or vacuum rating is reached. This may occur at high altitude, low vacuum or at very low speed. The units' operating limit is always determined by the maximum rating reached first. It can be any one of the three: Pressure, Temperature or Speed.

## Installation

ROOTS blowers & exhausters are treated after factory assembly to protect against normal atmospheric corrosion. The maximum period of internal protection is considered to be one year under average conditions, if shipping plugs & seals are not removed. Protection against chemical or salt water atmosphere is not provided. Avoid opening the unit until ready to start installation, as corrosion protection will be quickly lost due to evaporation.

If there is to be an extended period between installation and start up, the following steps should be taken to ensure corrosion protection.

- Coat internals of cylinder, gearbox and drive end bearing reservoir with Nox-Rust VCI-10 or equivalent. Repeat once a year or as conditions may require. Nox-Rust VCI-10 is petroleum soluble and does not have to be removed before lubricating. It may be obtained from Daubert Chemical Co., 2000 Spring Rd., Oak Brook, Ill. 60521.
- Paint shaft extension, inlet and discharge flanges, and all other exposed surfaces with Nox-Rust X-110 or equivalent.
- Seal inlet, discharge, and vent openings. It is not recommended that the unit be set in place, piped to the system, and allowed to remain idle for extended periods. If any part is left open to the atmosphere, the Nox-Rust VCI-10 vapor will escape and lose its effectiveness.
- Protect units from excessive vibration during storage.
- Rotate shaft three or four revolutions every two weeks.
- Prior to start up, remove flange covers on both inlet and discharge and inspect internals to insure absence of rust. Check all internal clearances. Also, at this time, remove gearbox and drive end bearing cover and inspect gear teeth and bearings for rust.

Because of the completely enclosed unit design, location of the installation is generally not a critical matter. A clean, dry and protected indoor location is preferred. However, an outdoor location will normally give satisfactory service. Important requirements are that the correct grade of lubricating oil be provided for expected operating temperatures, and that the unit be located so that routine checking and servicing can be performed conveniently. Proper care in locating driver and accessory equipment must also be considered.

Supervision of the installation by a ROOTS Service Engineer is not usually required for these units. Workmen with experience in installing light to medium weight machinery should be able to produce satisfactory results. Handling of the equipment needs to be accomplished with care, and in compliance with safe practices. Unit mounting must be solid, without strain or twist, and air piping must be clean, accurately aligned and properly connected.

**Bare-shaft Units:** Two methods are used to handle a unit without base. One is to use lifting lugs bolted into the top of the unit headplates. Test them first for tightness and frac-

tures by tapping with a hammer. In lifting, keep the direction of cable pull on these bolts as nearly vertical as possible. If lifting lugs are not available, lifting slings may be passed under the cylinder adjacent to the headplates. Either method prevents strain on the extended drive shaft.

**Packaged Units:** When the unit is furnished mounted on a baseplate, with or without a driver, use of lifting slings passing under the base flanges is required. Arrange these slings so that no strains are placed on the unit casing or mounting feet, or on any mounted accessory equipment. **DO NOT** use the lifting lugs in the top of the unit headplates.

Before starting the installation, remove plugs, covers or seals from unit inlet and discharge connections and inspect the interior completely for foreign material. If cleaning is required, finish by washing the cylinder, headplates and impeller thoroughly with an appropriate solvent. Turn the drive shaft by hand to make sure that the impellers turn freely at all points. Anti-rust compound on the connection flanges and drive shaft extension may also be removed at this time with the same solvent. Cover the flanges until ready to connect piping.

### Mounting

Care will pay dividends when arranging the unit mounting. This is especially true when the unit is a "bare-shaft" unit furnished without a baseplate. The convenient procedure may be to mount such a unit directly on a floor or small concrete pad, but this generally produces the least satisfactory results. It definitely causes the most problems in leveling and alignment and may result in a "Soft Foot" condition. Correct soft foot before operation to avoid unnecessary loading on the casing and bearings. Direct use of building structural framing members is not recommended.

For blowers without a base, it is recommended that a well anchored and carefully leveled steel or cast iron mounting plate be provided. The plate should be at least 1 inch (25 mm) thick, with its top surface machined flat, and large enough to provide leveling areas at one side and one end after the unit is mounted. It should have properly sized studs or tapped holes located to match the unit foot drilling. Proper use of a high quality machinist's level is necessary for adequate installation.

With the mounting plate in place and leveled, set the unit on it without bolting and check for rocking. If it is not solid, determine the total thickness of shims required under one foot to stop rocking. Place half of this under each of the diagonally-opposite short feet, and tighten the mounting studs or screws. Rotate the drive shaft to make sure the impellers turn freely. If the unit is to be direct coupled to a driving motor, consider the height of the motor shaft and the necessity for it to be aligned very accurately with the unit shaft. Best unit arrangement is directly bolted to the mounting plate while the driver is on shims of at least 1/8 inch (3mm) thickness. This allows adjustment of motor position in final shaft alignment by varying the shim thickness.

### Aligning

When unit and driver are factory mounted on a common baseplate, the assembly will have been properly aligned and is to be treated as a unit for leveling purposes. Satisfactory

installation can be obtained by setting the baseplate on a concrete slab that is rigid and free of vibration, and leveling the top of the base carefully in two directions so that it is free of twist. The slab must be provided with suitable anchor bolts. The use of grouting under and partly inside the leveled and shimmed base is recommended.

It is possible for a base-mounted assembly to become twisted during shipment, thus disturbing the original alignment. For this reason, make the following checks after the base has been leveled and bolted down. Disconnect the drive and rotate the unit shaft by hand. It should turn freely at all points. Loosen the unit foot hold-down screws and determine whether all feet are evenly in contact with the base. If not, insert shims as required and again check for free impeller rotation. Finally, if unit is direct coupled to the driver, check shaft and coupling alignment carefully and make any necessary corrections.

In planning the installation, and before setting the unit, consider how piping arrangements are dictated by the unit design and assembly. Drive shaft rotation must be established accordingly and is indicated by an arrow near the shaft.

Typical arrangement on vertical units has the drive shaft at the top with counterclockwise rotation and discharge to the left. Horizontal units are typically arranged with the drive shaft at the left with counterclockwise rotation and discharge down. See Figure 4 for other various unit arrangements and possible conversions.

When a unit is DIRECT COUPLED to its driver, the driver RPM must be selected or governed so as not to exceed the maximum speed rating of the unit. Refer to Table 1 for allowable speeds of various unit sizes.

A flexible type coupling should always be used to connect the driver and unit shafts.

When direct coupling a motor or engine to a blower you must insure there is sufficient gap between the coupling halves and the element to prevent thrust loading the blower bearings. When a motor, engine or blower is operated the shafts may expand axially. If the coupling is installed in such a manner that there is not enough room for expansion the blower shaft can be forced back into the blower and cause the impeller to contact the gear end headplate resulting in damage to the blower. The two shafts must be in as near perfect alignment in all directions as possible, and the gap must be established with the motor armature on its electrical center if end-play exists. Coupling manufacturer's recommendations for maximum misalignment, although acceptable for the coupling, are normally too large to achieve smooth operation and maximum life of the blower.

The following requirements of a good installation are recommended. When selecting a coupling to be fitted to the blower shaft ROOTS recommends a taper lock style coupling to insure proper contact with the blower shaft. If the coupling must have a straight bore the coupling halves must be fitted to the two shafts with a line to line thru .001" interference fit. Coupling halves must be warmed up per coupling manufacturer's recommendations. Maximum deviation in offset alignment of the shafts should not exceed .005" (.13 mm) total indicator reading, taken on the two coupling hubs. Maximum deviation from parallel of the inside coupling faces should not exceed .001" (.03 mm) when checked at six points around

the coupling.

When a unit is BELT DRIVEN, the proper selection of sheave diameters will result in the required unit speed. When selecting a sheave to be fitted to the blower shaft ROOTS recommends a taper lock style sheave to insure proper contact with the blower shaft. This flexibility can lead to operating temperature problems caused by unit speed being too low. Make sure the drive speed selected is within the allowable range for the specific unit size, as specified under Table 1.

Belt drive arrangements usually employ two or more V-belts running in grooved sheaves. Installation of the driver is less critical than for direct coupling, but its shaft must be level and parallel with the unit shaft. **The driver should be mounted on the inlet side of a vertical unit (horizontal piping) and on the side nearest to the shaft on a horizontal unit. SEE PAGE 6 - Acceptable Blower Drive Arrangement Options.** The driver must also be mounted on an adjustable base to permit installing, adjusting and removing the V-belts. To position the driver correctly, both sheaves need to be mounted on their shafts and the nominal shaft center distance known for the belt lengths to be used.

**CAUTION:** Drive couplings and sheaves (pulleys) should have an interference fit to the shaft of the blower (set screw types of attachment generally do not provide reliable service.) It is recommended that the drive coupling or sheave used have a taper lock style bushing which is properly sized to provide the correct interference fit required. Drive couplings, that require heating to fit on the blower shaft, should be installed per coupling manufacturer recommendations. A drive coupling or sheave should not be forced on to the shaft of the blower as this could affect internal clearances resulting in damage to the blower.

**Engine drive applications often require special consideration to drive coupling selection to avoid harmful torsional vibrations. These vibrations may lead to blower damage if not dampened adequately. It is often necessary to install a flywheel and/or a torsionally soft elastic element coupling based on the engine manufacturer recommendations.**

The driver sheave should also be mounted as close to its bearing as possible, and again should fit the shaft correctly. Position the driver on its adjustable base so that 2/3 of the total movement is available in the direction away from the unit, and mount the assembly so that the face of the sheave is accurately in line with the unit sheave. This position minimizes belt wear, and allows sufficient adjustment for both installing and tightening the belts. After belts are installed, adjust their tension in accordance with the manufacturer's instructions. However, only enough tension should be applied to prevent slippage when the unit is operating under load. Excessive tightening can lead to early bearing concerns or shaft breakage.

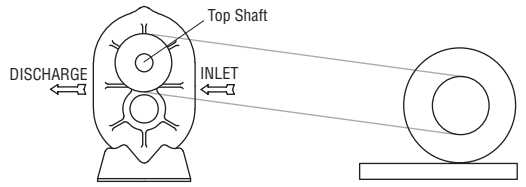
Before operating the drive under power to check initial belt tension, first remove covers from the unit connections. Make sure the interior is still clean, then rotate the shaft by hand. Place a coarse screen over the inlet connection to prevent anything being drawn into the unit while it is operating, and avoid standing in line with the discharge opening. Put oil in the sumps per instructions under **LUBRICATION**.

## Piping

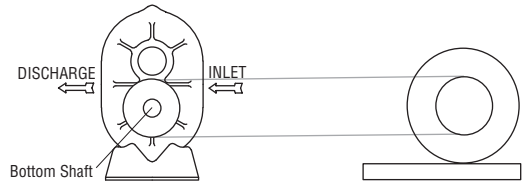
Before connecting piping, remove any remaining anti-rust compound from unit connections. Clean pipe should be no

## Acceptable Blower Drive Arrangement Options

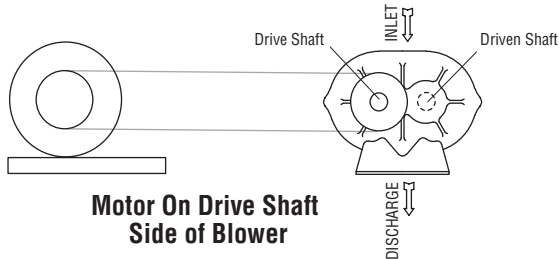
### ACCEPTABLE



**Motor On Inlet Side of Blower (Top Shaft)**

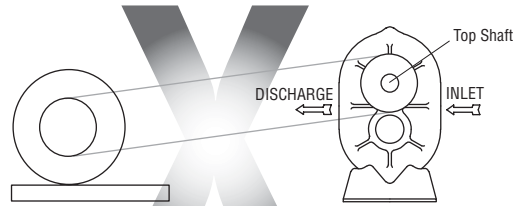


**Motor On Inlet Side of Blower (Bottom Shaft)**

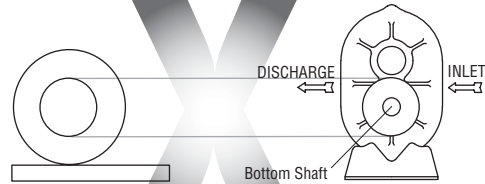


**Motor On Drive Shaft Side of Blower**

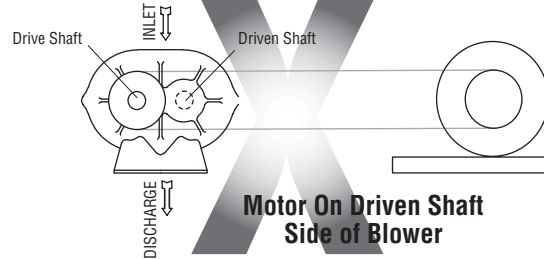
### UNACCEPTABLE



**Motor On Discharge Side of Blower (Top Shaft)**



**Motor On Discharge Side of Blower (Bottom Shaft)**



**Motor on Driven Shaft Side of Blower**

smaller than unit connections. In addition, make sure it is free of scale, cuttings, weld beads, or foreign material of any kind. To further guard against damage to the unit, especially when an inlet filter is not used, install a substantial screen of 16 mesh backed with hardware cloth at or near the inlet connections. Make provisions to clean this screen of collected debris after a few hours of operation. It should be removed when its usefulness has ended, as the wire will eventually deteriorate and small pieces going into the unit may cause serious damage.

Pipe flanges or male threads must meet the unit connections accurately and squarely. **DO NOT** attempt to correct misalignment by springing or cramping the pipe. In most cases this will distort the unit casing and cause impeller rubbing. In severe cases it can prevent operation or result in a broken drive shaft. For similar reasons, piping should be supported near the unit to eliminate dead weight strains. Also, if pipe expansion is likely to occur from temperature change, installation of flexible connectors or expansion joints is advisable.

Figure 3 represents an installation with all accessory items that might be required under various operating conditions. Inlet piping should be completely free of valves or other restrictions. When a shut-off valve can not be avoided, make sure a full size vacuum relief is installed nearest the unit inlet. This will protect against unit overload caused by accidental closing of the shut-off valve.

Need for an inlet silencer will depend on unit speed and pressure, as well as sound-level requirements in the general surroundings. An inlet filter is recommended, especially in dusty

or sandy locations. A discharge silencer is also normally suggested, even though Whispair units operate at generally lower noise levels than conventional rotary blowers. Specific recommendations on silencing can be obtained from your local ROOTS distributor.

Discharge piping requires a pressure relief valve, and should include a manual unloading valve to permit starting the unit under no-load conditions. Reliable pressure/vacuum gauges and good thermometers at both inlet and discharge are recommended to allow making the important checks on unit operating conditions. The back-pressure regulator shown in Figure 3 is useful mainly when volume demands vary while the unit operates at constant output. If demand is constant, but somewhat lower than the unit output, excess may be blown off through the manual unloading valve.

In multiple unit installations where two or more units operate with a common header, use of check valves is mandatory. These should be of a direct acting or free swinging type, with one valve located in each line between the unit and header. Properly installed, they will protect against damage from reverse rotation caused by air and material back-flow through an idle unit.

After piping is completed, and before applying power, rotate the drive shaft by hand again. If it does not move with uniform freedom, look for uneven mounting, piping strain, excessive belt tension or coupling misalignment.

**DO NOT** operate the unit at this time unless it has been lubricated per instructions.

## Technical Supplement for URAI® Gas Blowers

---

### Technical Supplement for 32, 33, 36, 42, 45, 47, 53, 56, 59, 65, 68, 615 Universal RAI-G blowers

ROOTS Universal RAI-G rotary positive gas blowers are a design extension of the basic Universal RAI blower model. URAI-G blower uses (4) mechanical seals in place of the standard inboard lip seals to minimize gas leakage into the atmosphere. The seal chambers are piped to plugged connections. These should be opened periodically to confirm that there is no build-up of oil due to leakage by the mechanical seal. Special traps may be required for vacuum operation. These units are intended for gases which are compatible with cast iron case material, steel shafts, 300/400 series stainless steel and carbon seal components, viton o-rings and the oil/grease lubricants. If there are any questions regarding application or operation of this gas blower, please contact factory.

**Precaution: URAI-G blowers: Care must be used when opening the head plate seal vent chamber plugs (43) as some gas will escape—if it is a pressure system, or the atmospheric air will leak in-if the system is under vacuum. There is a possibility of some gas leakage through the mechanical seals. This leakage on the gear end will escape through the gear box vent, and on the drive end, through the grease release fittings. If the gas leakage is undesirable, each seal chamber must be purged with an inert gas through one purge gas hole (43) per seal . There are two**

**plugged purge gas holes(1/8 NPT) provided per seal. The purge gas pressure must be maintained one psi above the discharge gas pressure. Also, there exists a possibility of gear end oil and drive end grease leakage into the gas stream.**

The lubricants selected must be compatible with the gas.

### URAI GAS Blower Oil and Grease Specifications

The specified oil should be ROOTS synthetic P/N 813-106- of the proper viscosity.

When servicing drive end bearings of a Gas blower, use the specified NLGI #2 premium grade aluminum complex\* grease, ROOTS P/N T20019001, with 300°F (149°C) service temperature and moisture resistance and good mechanical stability.

\*ROOTS Synthetic Oil & Grease is superior in performance to petroleum based products. It has high oxidation stability, excellent corrosion protection, extremely high film strength and low coefficient of friction. Typical oil change intervals are increased 2-3 times over petroleum based lubricants. Also, ROOTS Synthetic Oil is 100% compatible with petroleum based oils. Simply drain the oil in the blower and refill the reservoirs with ROOTS Synthetic Oil to maintain optimum performance of your ROOTS blower.

## Lubrication

Due to sludge build-up and seal leakage problems, Roots recommendation is **DO NOT USE** Mobil SHC synthetic oils in Roots blowers.

### For Units with a Grease Lubricated Drive End

A simple but very effective lubrication system is employed on the drive shaft end bearings. Hydraulic pressure relief fittings are provided to vent any excess grease, preventing pressure build-up on the seals. A restriction plug and metering orifice prevent loss of lubricant from initial surges in lubricant pressure but permit venting excess lubricant under steadily rising pressures.

For grease lubricated drive end blowers see page 16, table 4, regarding specified greasing intervals.

When servicing drive end bearings of Non Gas blower, use the specified NLGI #2 premium grade microgel grease with 250°F (121°C) service temperature and moisture resistance and good mechanical stability. ROOTS specifies Shell Darina EP NLGI Grade 2. Product Code 71522 or Shell Darina SD 2 product code 506762B.

### URAI GAS Blower Oil and Grease Specifications

The specified oil should be ROOTS synthetic P/N 813-106- of the proper viscosity.

When servicing drive end bearings of a Gas blower, use the specified NLGI #2 premium grade aluminum complex\* grease, ROOTS P/N T20019001, with 300°F (149°C) service temperature and moisture resistance and good mechanical stability.

**NOTE: Lithium based greases are not compatible with the ROOTS Synthetic grease used when assembling a Gas blower or the non-soap base grease used when assembling a standard URAI blower. Lithium based grease is not approved for any ROOTS blowers.**

Using a pressure gun, slowly force new lubricant into each drive end bearing housing until traces of clean grease comes out of the relief fitting. The use of an electric or pneumatic grease gun could force the grease in too rapidly and thus invert the seals and should not be used.

To fill the gearbox, remove the breather plug (25) and the oil overflow plug (21) - see page 14. Fill the reservoir up to the overflow hole. Place the breather and the overflow plug back into their respective holes.

After a long shutdown, it is recommended that the grease fittings be removed, the old grease flushed out with kerosene or #10 lubricating oil, drained thoroughly, and bearings refilled with new grease. Be sure grease relief fittings are reinstalled. Grease should be added using a hand operated grease gun to the drive end bearings at varying time intervals depending on duty cycle and RPM. Table 4 has been prepared as a general greasing schedule guide based on average operating conditions. More frequent intervals may be necessary depending on the grease operating temperature and unusual circumstances.

### For Units with Splash Lubrication on Both Ends

Bearings and oil seals are lubricated by the action of the timing gears or oil slingers which dip into the main oil sumps

causing oil to splash directly on gears and into bearings and seals. A drain port is provided below each bearing to prevent an excessive amount of oil in the bearings. Seals located inboard of the bearings in each headplate effectively retain oil within the sumps. Any small leakage that may occur should the seals wear passes into a cavity in each vented headplate and is drained downward.

Oil sumps on each end of the blower are filled by removing top vent plugs, Item (25), and filling until oil reaches the middle of the oil level sight gauge when the unit is not operating, Item (45 or 53), **DO NOT FILL PAST THE MIDDLE OF THE SIGHT GLASS.**

Initial filling of the sumps should be accomplished with the blower not operating, in order to obtain the correct oil level. Approximate oil quantities required for blowers of the various models and configurations are listed in Table 3. Use a good grade of industrial type non-detergent, rust inhibiting, anti-foaming oil and of correct viscosity per Table 2. **\*ROOTS synthetic oil (ROOTS P/N 813-106-) is highly recommended and specified.** ROOTS does not recommend automotive type lubricants, as they are not formulated with the properties mentioned above.

The oil level may rise or fall on the gauge during operation, to an extent depending somewhat on oil temperature and blower speed.

Proper lubrication is usually the most important single consideration in obtaining maximum service life and satisfactory operation from the unit. Unless operating conditions are quite severe, a weekly check of oil level and necessary addition of lubricant should be sufficient. During the first week of operation, check the oil levels in the oil sumps about once a day, and watch for leaks. Replenish as necessary. Thereafter, an occasional check should be sufficient. It is recommended that the oil be changed after initial 100 hours of operation. Frequent oil changing is not necessary unless the blower is operated in a very dusty location.

Normal life expectancy of petroleum based oils is about 2000 hours with an oil temperature of about 180°F (82°C). As the oil temperature increases by increments of 15-18°F (8°C - 10°C), the life is reduced by half. Example: Oil temperatures of 210-216°F (99°C - 102°C) will produce life expectancy of 1/4 or 500 hours. Therefore, it is considered normal to have oil change periods of 500 hours with petroleum based oils.

Normal life expectancy of ROOTS™ Synthetic Oil is about 4000 to 8000 hours with an oil temperature of about 180°F (82°C). As the oil temperature increases by increments of 15-18°F (8°C - 10°C), the life is reduced by half. Example: Oil temperatures of 210-216°F (99°C - 102°C) will produce life expectancy of 1/4 or 1000 to 2000 hours.

**NOTE:** To estimate oil temperature, multiply the discharge temperature of the blower by 0.80. Example: if the discharge air temperature of the blower is 200° F, it is estimated that the oil temperature is 160° F.

\*ROOTS™ Synthetic Oil & Grease is superior in performance to petroleum based products. It has high oxidation stability, excellent corrosion protection, extremely high film strength and low coefficient of friction. Typical oil change intervals are increased 2-3 times over petroleum based lubricants. Also, ROOTS™ Synthetic Oil is 100% compatible with petroleum based oils. Simply drain the oil in the blower and refill the reservoirs with ROOTS™ Synthetic Oil to maintain optimum performance of your ROOTS™ blower.



## Operation

Before operating a blower under power for the first time, recheck the unit and the installation thoroughly to reduce the likelihood of avoidable troubles. Use the following procedure check list as a guide, but consider any other special conditions in the installation.

- Be certain that no bolts, tools, rags, or debris have been left in the blower air chamber or piping.
- If an outdoor intake without filter is used, be sure the opening is located so it cannot pick up dirt and is protected by a strong screen or grille. Use of the temporary protective screen as described under INSTALLATION is strongly recommended.
- Recheck blower leveling, drive alignment and tightness of all mounting bolts if installation is not recent. If belt drive is used, adjust belt tension correctly.
- Turn drive shaft by hand to make sure impellers still rotate without bumping or rubbing at any point.
- Ensure oil levels in the main oil sumps are correct.
- Check lubrication of driver. If it is an electric motor, be sure that power is available and that electrical overload devices are installed and workable.
- Open the manual unloading valve in the discharge air line. If a valve is in the inlet piping, be sure it is open.
- Bump blower a few revolutions with driver to check that direction of rotation agrees with arrow near blower shaft, and that both coast freely to a stop.

After the preceding points are cleared, blower is ready for trial operation under “no-load” conditions. The following procedure is suggested to cover this initial operation test period.

- a. Start blower, let it accelerate to full speed, then shut off. Listen for knocking sounds, both with power on and as speed slows down.
- b. After blower comes to a complete stop, repeat above, but let blower run 2 or 3 minutes. Check for noises, such as knocking sounds.
- c. After blower comes to a complete stop, operate blower for about 10 minutes unloaded. Check oil levels. Observe cylinder and headplate surfaces for development of hot spots such as burned paint, indicating impeller rubs. Be aware of any noticeable increase in vibration.

Assuming that all trials have been satisfactory, or that necessary corrections have been made, the blower should now have a final check run of at least one hour under normal operating conditions. After blower is restarted, gradually

close the discharge unloading valve to apply working pressure. At this point it is recommended that a pressure gauge or manometer be connected into the discharge line if not already provided, and that thermometers be in both inlet and discharge lines. Readings from these instruments will show whether pressure or temperature ratings of the blower are being exceeded.

During the final run, check operating conditions frequently and observe the oil levels at reasonable intervals. If excessive noise or local heating develops, shut down immediately and determine the cause. If either pressure rise or temperature rise across the blower exceeds the limit specified in this manual, shut down and investigate conditions in the piping system. Refer to the TROUBLESHOOTING CHECKLIST for suggestions on various problems that may appear.

The blower should now be ready for continuous duty operation at full load. During the first few days make periodic checks to determine whether all conditions remain steady, or at least acceptable. This may be particularly important if the blower is supplying air to a process system where conditions can vary. At the first opportunity, stop the blower and clean the temporary inlet protective screen. If no appreciable amount of debris has collected, the screen may be removed. See comments under INSTALLATION. At this same time, verify leveling, coupling alignment or belt tension, and mounting bolt tightness.

Should operating experience prove that blower capacity is a little too high for the actual air requirements, a small excess may be blown off continuously through the manual unloading or vent valve. Never rely on the pressure relief valve as an automatic vent. Such use may cause the discharge pressure to become excessive, and can also result in failure of the valve itself. If blower capacity appears to be too low, refer to the TROUBLESHOOTING CHECKLIST.

### Vibration Assessment Criteria

With measurements taken at the bearing locations on the housings, see chart below for an appropriate assessment guide for rotary lobe blowers rigidly mounted on stiff foundations.

In general, blower vibration levels should be monitored on a regular basis and the vibration trend observed for progressive or sudden change in level. If such a change occurs, the cause should be determined through spectral analysis.

As shown on the chart below, the level of all pass vibration will determine the need to measure discrete frequency vibration levels and the action required.

All Pass Vibration (in/sec)	Discrete Frequency Vibration (in/sec)	Action
0.45 or less	N/R	Acceptable
Greater than 0.45 but 1.0 or less	0.45 or less @ any frequency	Acceptable
	Greater than 0.45 @ any frequency	Investigate
Greater than 1.0	Less than 1.0	Investigate
	Greater than 1.0	Investigate

## Troubleshooting Checklist

Trouble	Item	Possible Cause	Remedy
No flow	1	Speed too low	Check by tachometer and compare with published performance
	2	Wrong rotation	Compare actual rotation with Figure 1 Change driver if wrong
	3	Obstruction in piping	Check piping, valves, silencer to assure open flow path
Low capacity	4	Speed too low	See item 1, If belt drive, check for slippage and readjust tension
	5	Excessive pressure rise	Check inlet vacuum and discharge pressure and compare with Published performance
	6	Obstruction in piping	See item 3
	7	Excessive slip	Check inside of casing for worn or eroded surfaces causing excessive clearances
Excessive power	8	Speed too high	Check speed and compare with published performance
	9	Excessive pressure rise	See Item 5
	10	Impeller rubbing	Inspect outside of cylinder for high temperature areas, then check for impeller contact at these points. Correct blower mounting, drive alignment
	11	Scale, sludge, rust or product build up	Clean blower appropriately
Damage to bearings or gears	12	Inadequate lubrication	Check oil sump levels in gear and drive end headplates
	13	Excessive lubrication	Check oil levels. If correct, drain and refill with clean oil of recommended grade
	14	Excessive pressure rise	See Item 5
	15	Coupling misalignment	Check carefully. Realign if questionable
Vibration	16	Excessive belt tension	Readjust for correct tension
	17	Misalignment	See Item 15
	18	Impellers rubbing	See Item 10
	19	Worn bearings/gears	Check gear backlash and condition of bearings, and replace as indicated
	20	Unbalanced or rubbing impeller	Scale or process material may build up on casing and impellers, or inside impellers. Remove build-up to restore original clearances and impeller balance
	21	Driver or blower loose	Tighten mounting bolts securely
	22	Piping resonances	Determine whether standing wave pressure pulsations are present in the piping
	23	Scale/sludge build-ups	Clean out interior of impeller lobes to restore dynamic balance
Driver stops, or will not start	24	Casing strain	Re-work piping alignment to remove excess strain
	25	Impeller stuck	Check for excessive hot spot on headplate or cylinder. See item 10. Look for defective shaft bearing and/or gear teeth
	26	Scale, sludge, rust or product build-up	Clean blower appropriately
Excessive breather	27	Broken seal	Replace seals
Blow-by or excessive oil leakage to vent area	28	Defective O-ring	Replace seals and O-ring
Excessive oil leakage in vent area	29	Defective/plugged breather	Replace breather and monitor oil leakage
	30	Oil level too high	Check sump levels in gear and drive headplates.
	31	Oil type or viscosity incorrect	Check oil to insure it meets recommendations. Drain then fill with clean oil of recommended grade.
	32	Blower running hot	Check blower operating conditions to ensure they are within the operating limitations defined in this manual.

## Inspection & Maintenance: Universal RAI® series blowers

A good program of consistent inspection and maintenance is the most reliable method of minimizing repairs to a blower. A simple record of services and dates will help keep this work on a regular schedule. Basic service needs are:

- Lubrication
- Checking for hot spots
- Checking for increases or changes in vibration and noise
- Recording of operating pressures and temperatures

Above all, a blower must be operated within its specified rating limits, to obtain satisfactory service life.

A newly installed blower should be checked often during the first month of full-time operation. Attention there after may be less frequent assuming satisfactory performance. Lubrication is normally the most important consideration and weekly checks of lubricant levels in the gearbox and bearing reservoirs should be customary. Complete oil change schedules are discussed under **LUBRICATION**.

Driver lubrication practices should be in accordance with the manufacturer's instructions. If direct connected to the blower through a lubricated type coupling, the coupling should be checked and greased each time blower oil is changed. This will help reduce wear and prevent unnecessary vibration. In a belted drive system, check belt tension periodically and inspect for frayed or cracked belts.

In a new, and properly installed, unit there is no contact between the two impellers, or between the impellers and cylinder or headplates. Wear is confined to the bearings (which support and locate the shafts) the oil seals, and the timing gears. All are lubricated and wear should be minimal if clean oil of the correct grade is always used. Seals are subject to deterioration as well as wear, and may require replacement at varying periods.

Shaft bearings are designed for optimum life under average conditions with proper lubrication and are critical to the service life of the blower. Gradual bearing wear may allow a shaft position to change slightly, until rubbing develops between impeller and casing. This will cause spot heating, which can be detected by observing these surfaces. Sudden bearing failure is usually more serious. Since the shaft and impeller are no longer supported and properly located, extensive general damage to the blower casing and gears is likely to occur.

Oil seals should be considered expendable items, to be replaced whenever drainage from the headplate vent cavity becomes excessive or when the blower is disassembled for

any reason. Some oil seal leakage may occur since an oil film under the lip is required for proper operation. Periodically leaked oil should be wiped off from surfaces. Minor seal leakage should not be considered as indicating seal replacement.

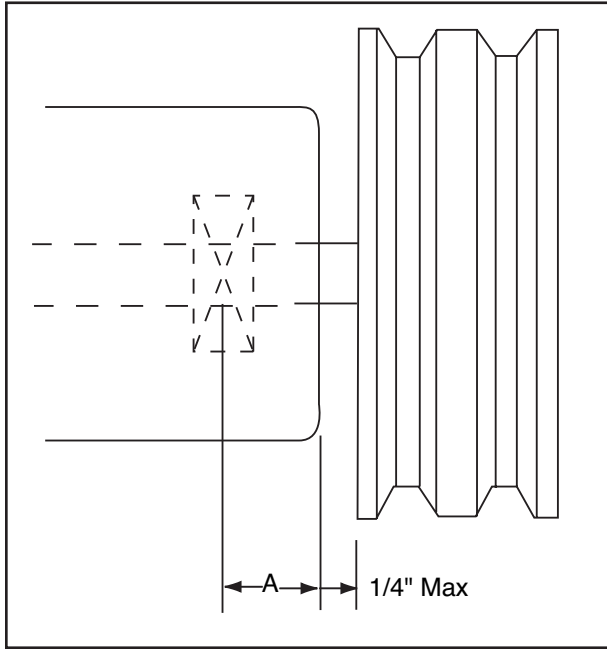
Timing gear wear, when correct lubrication is maintained, should be negligible. Gear teeth are cut to provide the correct amount of backlash, and gears correctly mounted on the shafts will accommodate a normal amount of tooth wear without permitting contact between lobes of the two impellers. However, too high an oil level will cause churning and excessive heating. This is indicated by unusually high temperature at the bottom of the gear housing. Consequent heating of the gears will result in loss of tooth-clearance, backlash and rapid wear of the gear teeth usually will develop. Continuation of this tooth wear will eventually produce impeller contacts (knocking), and from this point serious damage will be unavoidable if blower operation is continued. A similar situation can be produced suddenly by gear tooth fracture, which is usually brought on by sustained overloading or momentary shock loads.

Problems may also develop from causes other than internal parts failure. Operating clearances within a blower are only a few thousandths of an inch. This makes it possible for impeller interference or casing rubs to result from shifts in the blower mounting, or from changes in piping support. If this type of trouble is experienced, and the blower is found to be clean, try removing mounting strains. Loosen blower mounting bolts and reset the leveling and drive alignment. Then tighten mounting again, and make sure that all piping meets blower connections accurately and squarely. Foreign materials in the blower will also cause trouble, which can only be cured by disconnecting the piping and thoroughly cleaning the blower interior.

A wide range of causes & solutions for operating troubles are covered in the **TROUBLE SHOOTING CHECKLIST**. The remedies suggested should be performed by qualified mechanics with a good background. Major repairs generally are to be considered beyond the scope of maintenance, and should be referred to an authorized ROOTS distributor.

Warranty failures should not be repaired at all, unless specific approval has been obtained through ROOTS before starting work. Unauthorized disassembly within the warranty period may void the warranty.

Figure 2 - Allowable Overhung Loads for V-Belt Drives Universal RAI®/URAI®-J Units



$$\text{Belt Pull lbs} = \frac{252100 \cdot \text{Motor HP}}{\text{Blower RPM} \cdot \text{Sheave Diameter}}$$

$$\text{Shaft Load (lb.in)} = \text{Belt Pull} \cdot \left( A + \frac{1}{4} + \frac{\text{Sheave Width}}{2} \right)$$

Frame Size	Dimension "A"	Max Allowable Shaft Load (lb-in.)	Min Sheave Diameter
22, 24	0.61	150	4.00
32, 33, 36	0.80	400	5.00
42, 45, 47	1.02	650	5.00
53, 56, 59	1.13	1,325	6.00
65, 68, 615	1.36	2,250	8.00
76, 711, 718	1.16	2,300	9.50

**NOTE:**

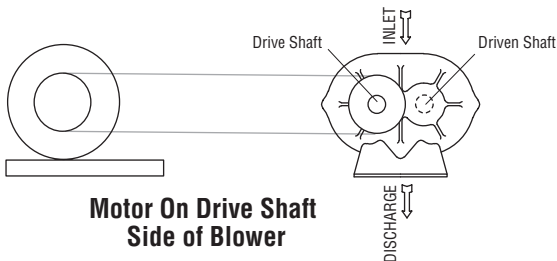
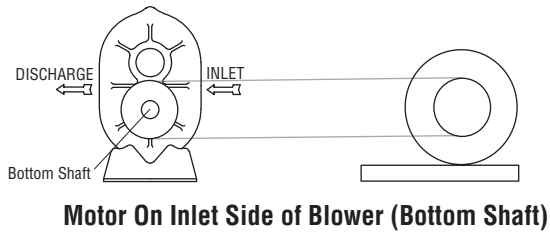
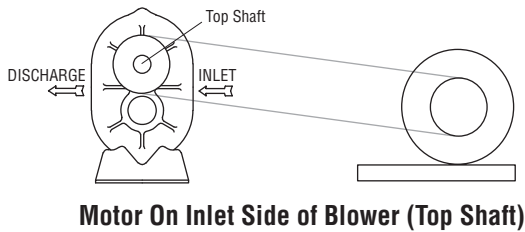
Arc of sheave belt contact on the smaller sheave not to be less than 170°

Driver to be installed on the inlet side for vertical units, and on the drive shaft side for horizontal units.

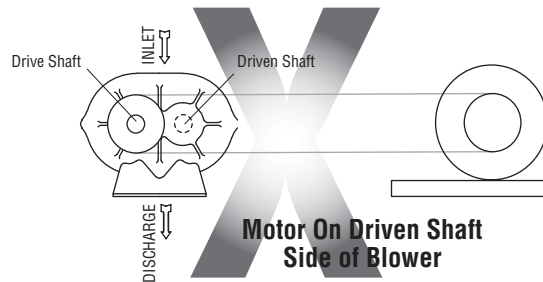
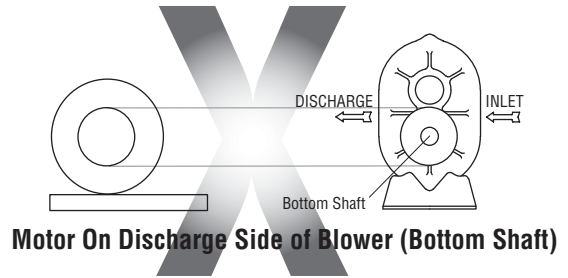
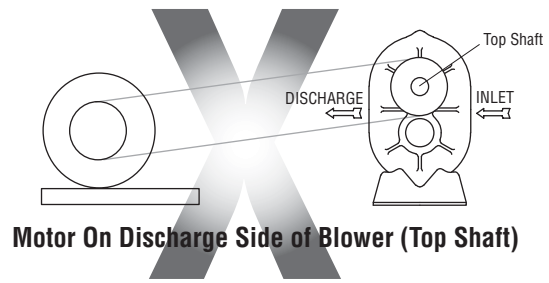
ROOTS recommends the use of two or more 3V, 5V or 8V belts and sheaves.

**Acceptable Blower Drive Arrangement Options**

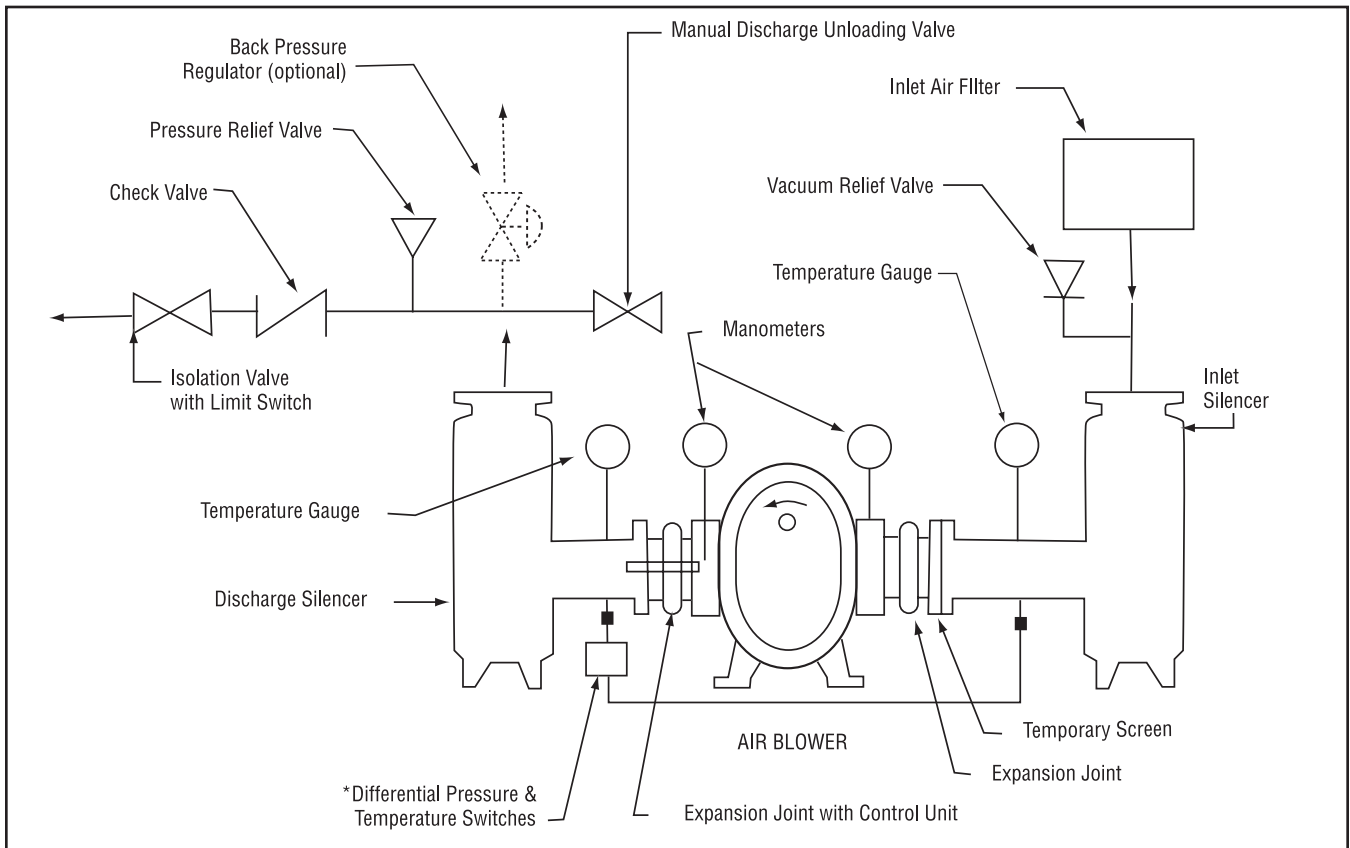
**ACCEPTABLE**



**UNACCEPTABLE**

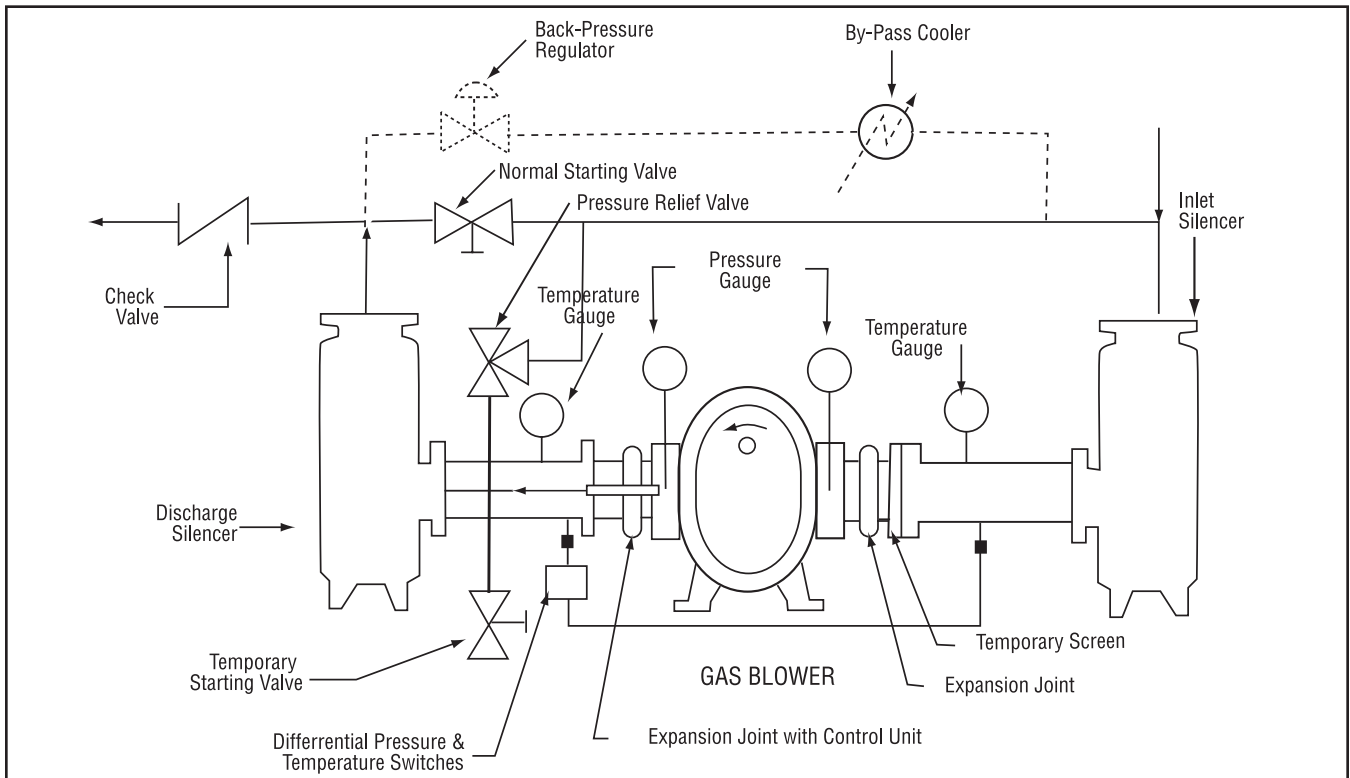


**Figure 3a - Air Blower Installation with Accessories**



Above are suggested locations for available accessories.

**Figure 3b - Gas Blower Installation with Accessories**



Above are suggested locations for available accessories.

Figure 4

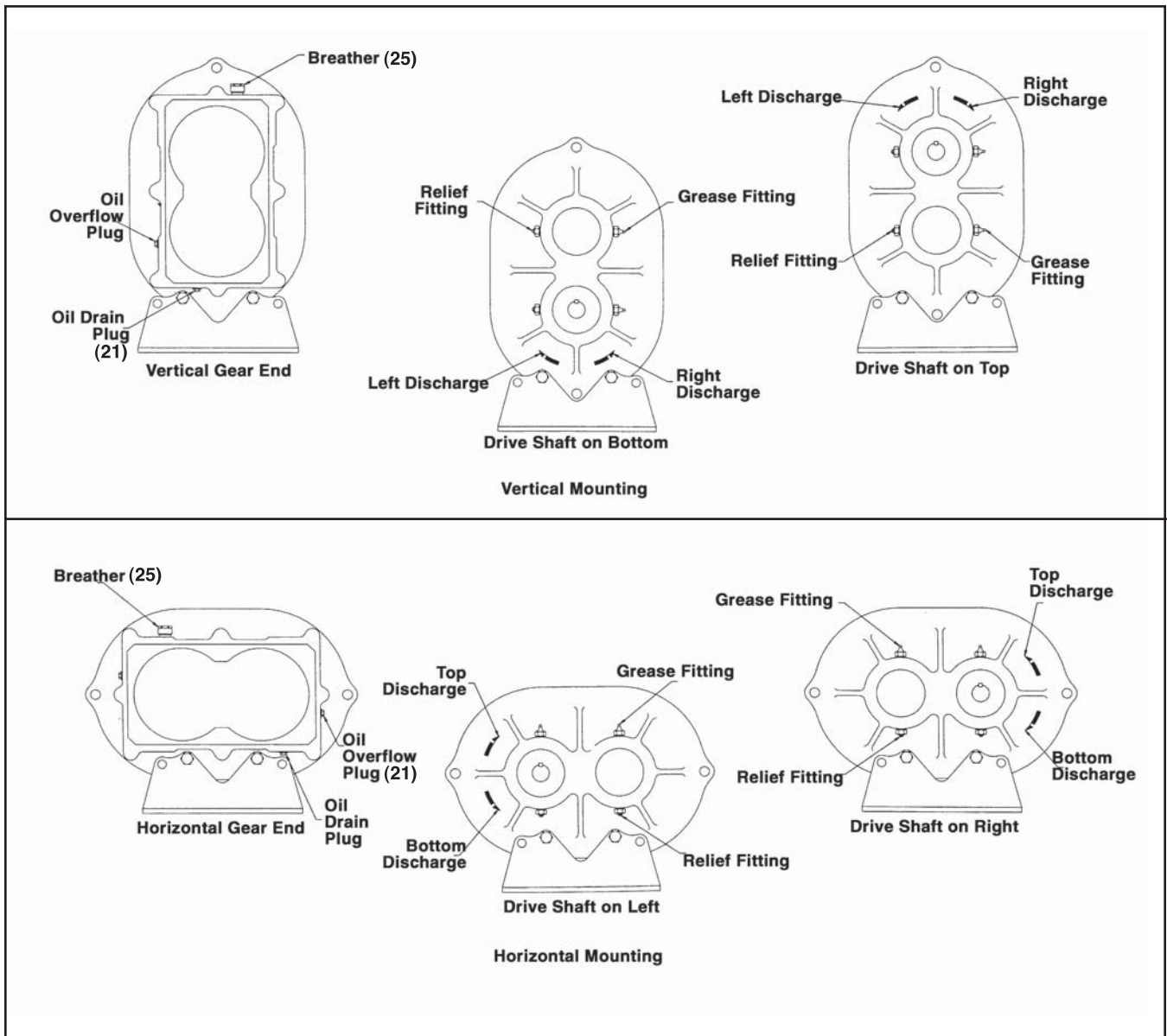
Blower Orientation Conversion

Model	Reversible Rotation	Whispair™ Design
Universal RAI	yes	no
URAI-J Whispair™	no	yes
URAI-G	yes	no

**Special Note:** WHISPAIR™ models are designed to operate with only one shaft rotation direction to take full advantage of the Whispair feature. Therefore, a WHISPAIR™ blower may be operated in the following combinations.

- CCW Rotation: Bottom Shaft; Right side discharge or a Left Shaft; Bottom discharge
  - CCW Rotation: Top Shaft; Left side discharge or a Right Shaft; Top discharge
- or
- CW Rotation: Bottom Shaft; Left side discharge or a Right Shaft Bottom discharge
  - CW Rotation: Top Shaft; Right side discharge or a Left Shaft Top discharge

Blower Orientation and Lubrication Points: Grease Lubricated Drive End  
Universal RAI series & URAI-G gas blowers



Drive End Breather Orientation for U-RAI series - DSL with Oil Lube

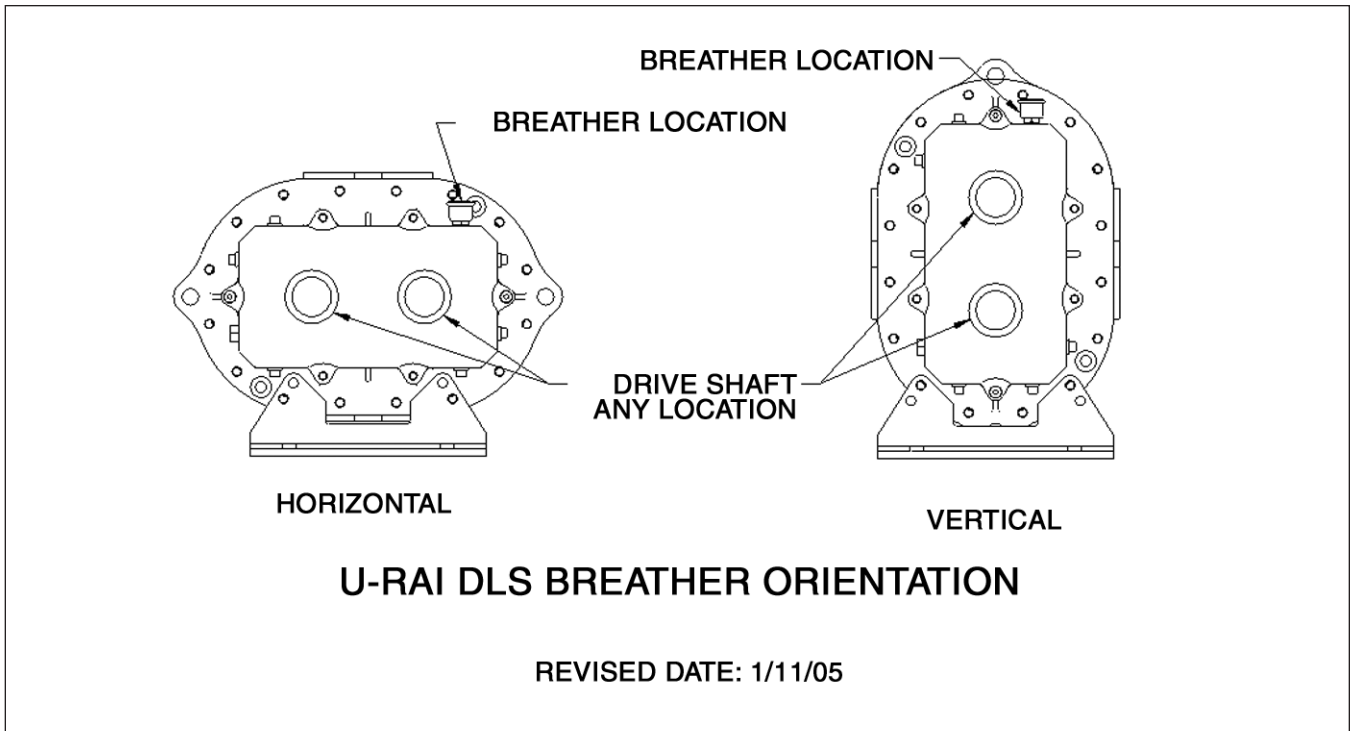


Table 1 - Universal RAI series, Universal URAI-DSI & URAI-G gas blower, Maximum Allowable Operating Conditions

Frame Size	Gear Diameter (Inch)	Speed RPM	Temp. Rise F° (C°)	Delta Pressure PSI (mbar)	Inlet Vacuum INHG (mbar)
22	2.5	5275	225 (125)	12 (827)	15 (500)
24	2.5	5275	210 (117)	7 (483)	15 (500)
32	3.5	3600	240 (133)	15 (1034)	16 (539)
33	3.5	3600	225 (125)	12 (827)	15 (500)
36	3.5	3600	225 (125)	7 (483)	15 (500)
42	4.0	3600	240 (133)	15 (1034)	16 (539)
45	4.0	3600	225 (125)	10 (690)	16 (539)
47	4.0	3600	225 (125)	7 (483)	15 (500)
53	5.0	2850	225 (125)	15 (1034)	16 (539)
56	5.0	2850	225 (125)	13 (896)	16 (539)
59	5.0	2850	225 (125)	7 (483)	15 (500)
65	6.0	2350	250 (130)	15 (1034)	16 (539)
68	6.0	2350	240 (133)	14 (965)	16 (539)
615	6.0	2350	130 (72)	7 (483)	14 (472)
76	7.0	2050	250 (139)	15 (1034)	16 (539)
711	7.0	2050	225 (125)	10 (690)	16 (539)
718	7.0	2050	130 (72)	6 (414)	12 (405)

**Table 2 - Recommended Oil Grades**

Ambient Temperature °F (°C)	ISO Viscosity No.
Above 90° (32°)	320
32° to 90° (0° to 32°)	220
0° to 32° (-18° to 0°)	150
Below 0° (-18°)	100

**URAI GAS Blower Oil and Grease Specifications**

The specified oil should be ROOTS synthetic P/N 813-106- of the proper viscosity.

**Table 3 - Approximate Oil Sump Capacities**

These capacities are provided to assist in stocking the correct amount of oil. Exact sump capacities may differ slightly. See “Lubrication” section for proper filling instructions.

**UNIVERSAL RAI, URAI-J, URAI-G**

Frame Size	Gear End Capacity Fl. Oz. (Liters)	
	Vertical	Horizontal
22	3.4 (.1)	6.1 (.18)
24	3.4 (.1)	6.1 (.18)
32	8.5 (.25)	16.0 (.47)
33	8.5 (.25)	16.0 (.47)
36	8.5 (.25)	16.0 (.47)
42	12.7 (.37)	14.5 (.43)
45	12.7 (.37)	14.5 (.43)
47	12.7 (.37)	14.5 (.43)
53	16.0 (.47)	27.6 (.82)
56	16.0 (.47)	27.6 (.82)
59	16.0 (.47)	27.6 (.82)
65	28.3 (.84)	52.1 (1.54)
68	28.3 (.84)	52.1 (1.54)
615	28.3 (.84)	52.1 (1.54)
76	32.3 (.96)	59.5 (1.76)
711	32.3 (.96)	59.5 (1.76)
718	32.3 (.96)	59.5 (1.76)

**UNIVERSAL URAI series-DSL Splash Lubricated Drive End**

Note that the gear end sump capacity is provided on the adjacent table.

Frame Size	Drive End Capacity Fl. Oz. (Liters)	
	Vertical	Horizontal
32	4.0 (.12)	6.5 (.19)
33	4.0 (.12)	6.5 (.19)
36	4.0 (.12)	6.5 (.19)
42	5.5 (.16)	10.8 (.32)
45	5.5 (.16)	10.8 (.32)
47	5.5 (.16)	10.8 (.32)
53	7.5 (.22)	14.8 (.44)
56	7.5 (.22)	14.8 (.44)
59	7.5 (.22)	14.8 (.44)
65	16 (0.47)	31 (0.91)
68	16 (0.47)	31 (0.91)
615	16 (0.47)	31 (0.91)

See page 14 and 15 for illustration of vertical and horizontal configurations.

**Table 4 - Universal URAI series with Grease Lubricated Drive End: Specified Bearing Greasing Intervals**

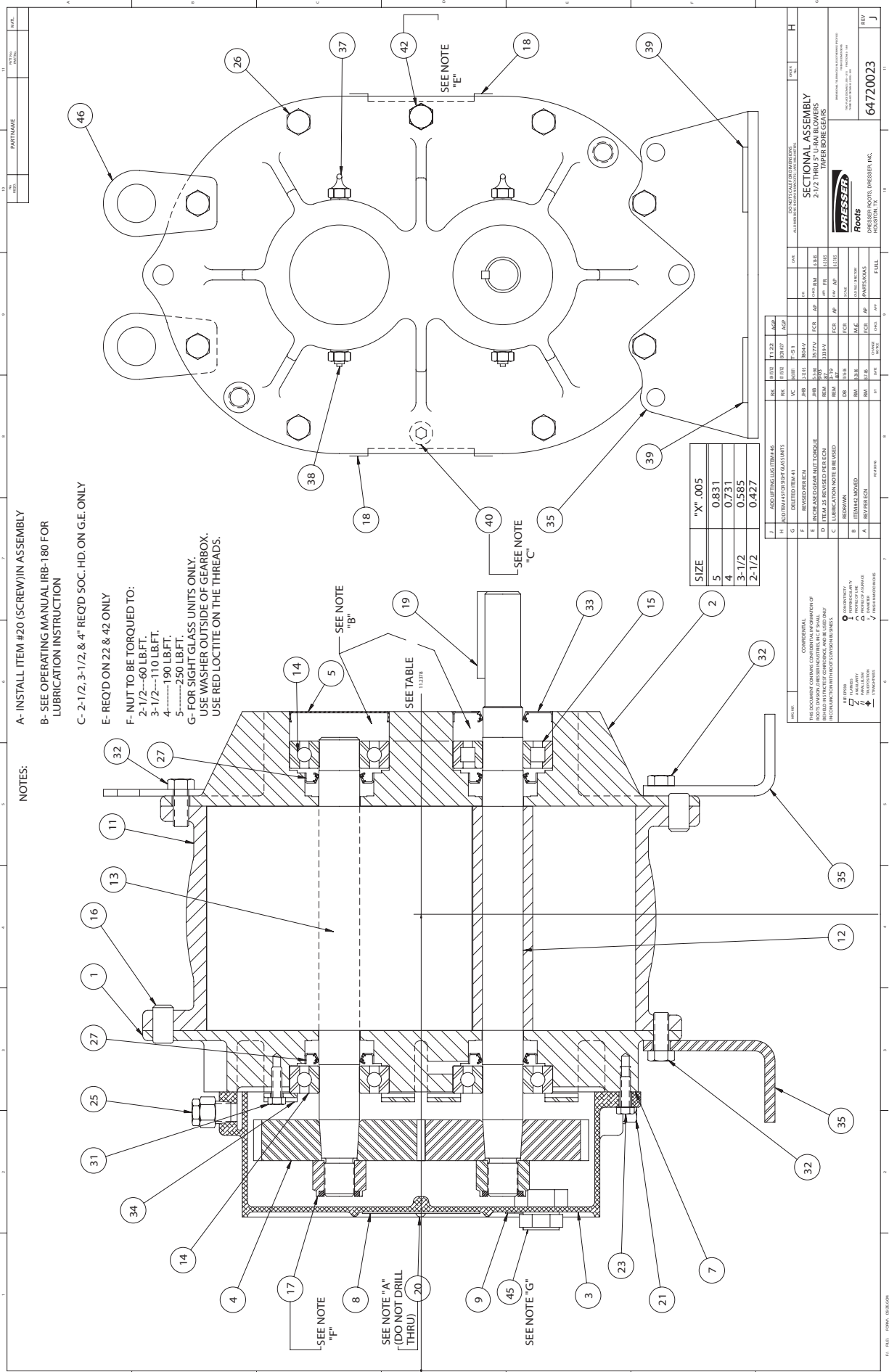
Speed In RPM	Operating Hours Per Day		
	8	16	24
	Greasing Intervals in Weeks		
750-1000	7	4	2
1000-1500	5	2	1
1500-2000	4	2	1
2000-2500	3	1	1
2500-3000	2	1	1
3000 and up	1	1	1

The specified grease for servicing drive end bearings of a Gas blower, use a NLGI #2 premium grade aluminum complex\* grease, ROOTS P/N T20019001 with 300°F (149°C) service temperature and moisture resistance and good mechanical stability.

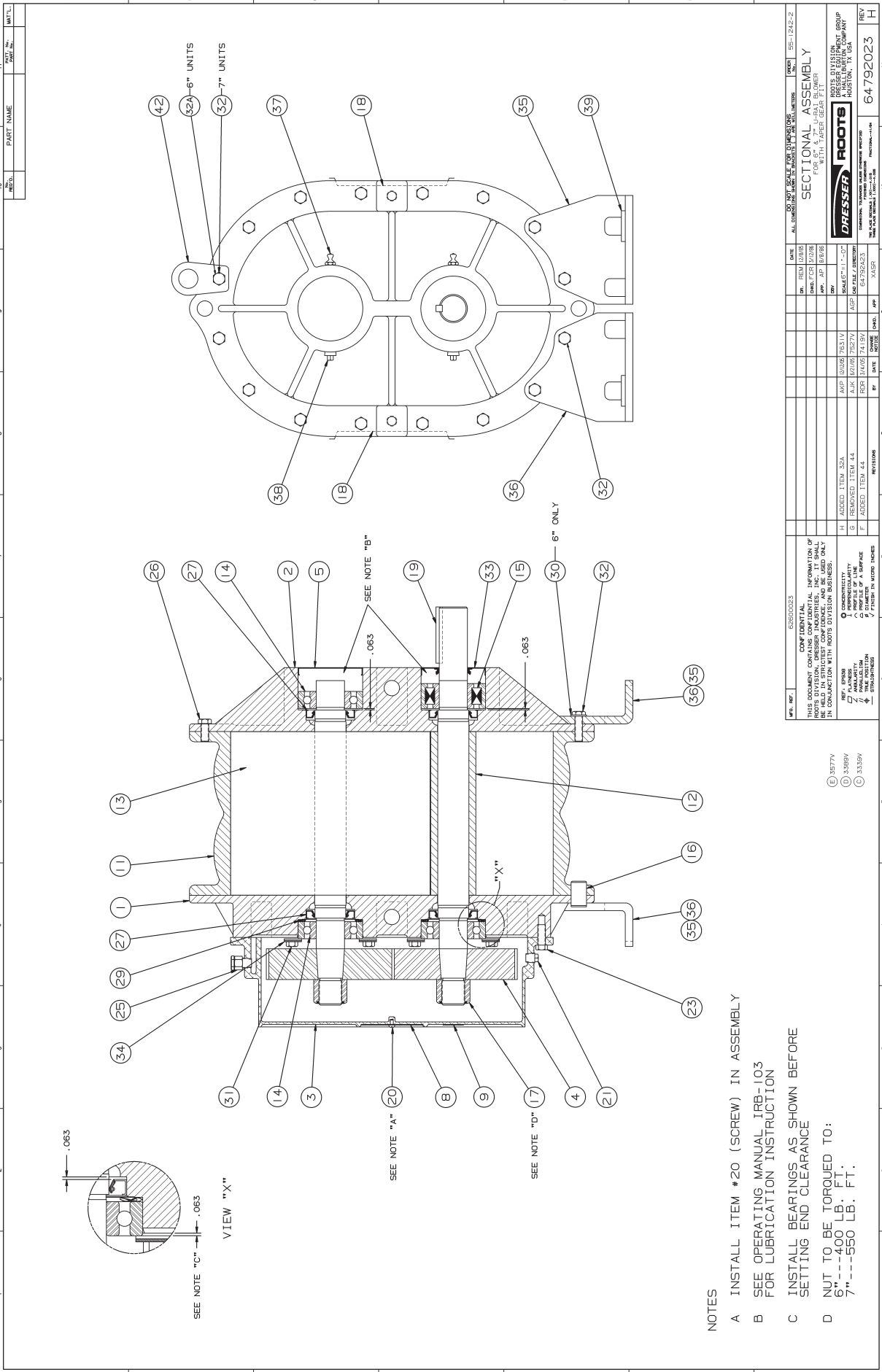
When servicing drive end bearings of Non Gas blower, use a NLGI #2 premium grade microgel grease with 250°F (121°C) service temperature and moisture resistance and good mechanical stability. ROOTS specifies Shell Darina EP NLGI Grade 2. Product Code 71522.

NOTE: Lithium based greases are not compatible with the ROOTS Synthetic grease used when assembling a Gas blower or the non-soap base grease used when assembling a standard URAI blower. Lithium based grease is not approved for any ROOTS blowers.





Assembly of UNIVERSAL RAI Series, Air Blowers, 2-1/2" Through 5" Gear Diameter



NOTES

- A INSTALL ITEM #20 (SCREW) IN ASSEMBLY
- B SEE OPERATING MANUAL IRB-103 FOR LUBRICATION INSTRUCTION
- C INSTALL BEARINGS AS SHOWN BEFORE SETTING END CLEARANCE
- D NUT TO BE TORQUED TO:  
6" ---400 LB. FT.  
7" ---550 LB. FT.

DATE	BY	CHKD.	APP.	REV.
03/01/00	WASER			1
05/12/00	WASER			2
07/27/00	WASER			3
08/23/00	WASER			4
09/11/00	WASER			5
10/27/00	WASER			6
11/09/00	WASER			7
12/07/00	WASER			8
01/09/01	WASER			9
02/09/01	WASER			10
03/09/01	WASER			11
04/09/01	WASER			12
05/09/01	WASER			13
06/09/01	WASER			14
07/09/01	WASER			15
08/09/01	WASER			16
09/09/01	WASER			17
10/09/01	WASER			18
11/09/01	WASER			19
12/09/01	WASER			20
01/10/02	WASER			21
02/10/02	WASER			22
03/10/02	WASER			23
04/10/02	WASER			24
05/10/02	WASER			25
06/10/02	WASER			26
07/10/02	WASER			27
08/10/02	WASER			28
09/10/02	WASER			29
10/10/02	WASER			30
11/10/02	WASER			31
12/10/02	WASER			32
01/11/03	WASER			33
02/11/03	WASER			34
03/11/03	WASER			35
04/11/03	WASER			36
05/11/03	WASER			37
06/11/03	WASER			38
07/11/03	WASER			39
08/11/03	WASER			40
09/11/03	WASER			41
10/11/03	WASER			42
11/11/03	WASER			43
12/11/03	WASER			44
01/12/04	WASER			45
02/12/04	WASER			46
03/12/04	WASER			47
04/12/04	WASER			48
05/12/04	WASER			49
06/12/04	WASER			50
07/12/04	WASER			51
08/12/04	WASER			52
09/12/04	WASER			53
10/12/04	WASER			54
11/12/04	WASER			55
12/12/04	WASER			56
01/13/05	WASER			57
02/13/05	WASER			58
03/13/05	WASER			59
04/13/05	WASER			60
05/13/05	WASER			61
06/13/05	WASER			62
07/13/05	WASER			63
08/13/05	WASER			64
09/13/05	WASER			65
10/13/05	WASER			66
11/13/05	WASER			67
12/13/05	WASER			68
01/14/06	WASER			69
02/14/06	WASER			70
03/14/06	WASER			71
04/14/06	WASER			72
05/14/06	WASER			73
06/14/06	WASER			74
07/14/06	WASER			75
08/14/06	WASER			76
09/14/06	WASER			77
10/14/06	WASER			78
11/14/06	WASER			79
12/14/06	WASER			80
01/15/07	WASER			81
02/15/07	WASER			82
03/15/07	WASER			83
04/15/07	WASER			84
05/15/07	WASER			85
06/15/07	WASER			86
07/15/07	WASER			87
08/15/07	WASER			88
09/15/07	WASER			89
10/15/07	WASER			90
11/15/07	WASER			91
12/15/07	WASER			92
01/16/08	WASER			93
02/16/08	WASER			94
03/16/08	WASER			95
04/16/08	WASER			96
05/16/08	WASER			97
06/16/08	WASER			98
07/16/08	WASER			99
08/16/08	WASER			100

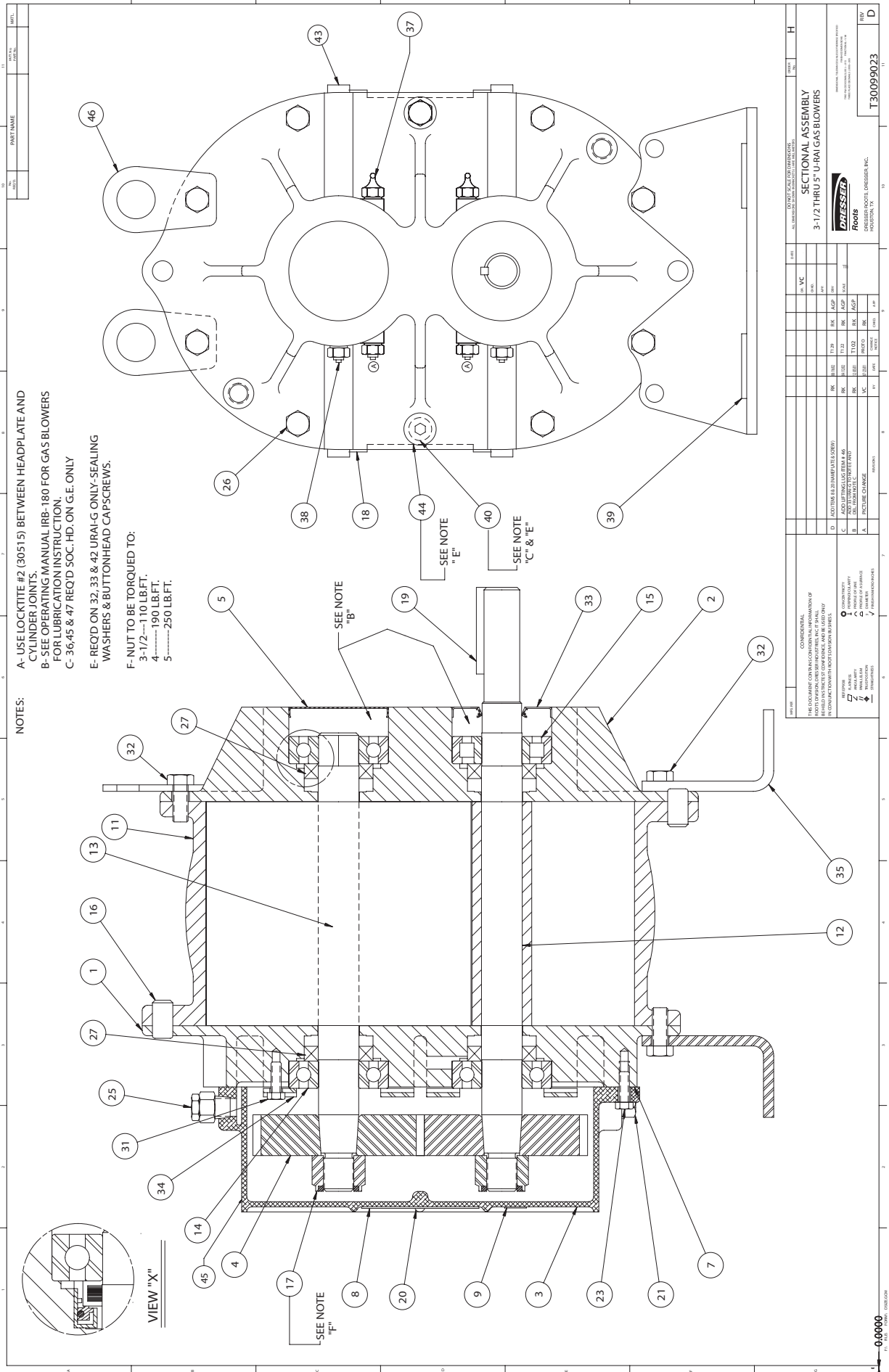
Assembly of UNIVERSAL RAI Blowers, 6" and 7" Diameter

FILE:VPMWBSZ6.SCH

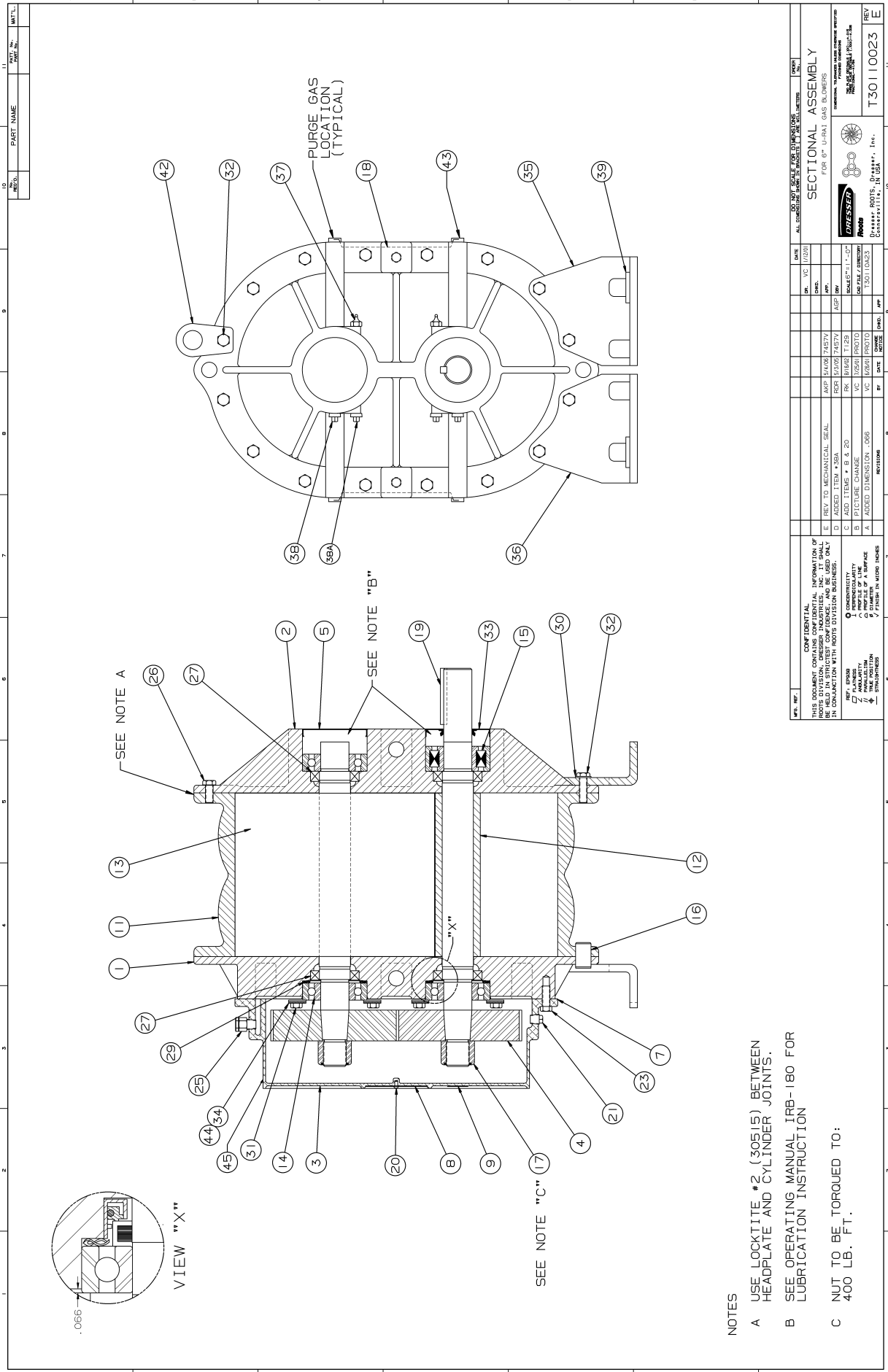
SECTIONAL ASSEMBLY  
 FOR 6" & 7" DIAMETER BLOWERS  
 WITH UPPER BEARING  
 SCALE 1:1 (ACTUAL)

DRESSER  
 DRESSER EQUIPMENT GROUP  
 HOUSTON, TX USA

64792023



Assembly of UNIVERSAL RAI-G Series Gas Blowers, 3-1/2" Through 5" Gear Diameter



NOTES

- A USE LOCKTITE #2 (30515) BETWEEN HEADPLATE AND CYLINDER JOINTS.
- B SEE OPERATING MANUAL IRB-180 FOR LUBRICATION INSTRUCTION
- C NUT TO BE TORQUED TO: 400 LB. FT.

REV.	DATE	BY	CHKD.	APP.	DESCRIPTION
E	11/2000	VC	VC	VC	REVISED TO ADD PURGE GAS LOCATION
D					REV TO MECHANICAL SEAL
C					ADDED ITEM #26A
B					ADDED ITEM #32
A					ADDED DIMENSION .096

REV.	DATE	BY	CHKD.	APP.	DESCRIPTION
E					REVISED TO ADD PURGE GAS LOCATION
D					REV TO MECHANICAL SEAL
C					ADDED ITEM #26A
B					ADDED ITEM #32
A					ADDED DIMENSION .096

REV.	DATE	BY	CHKD.	APP.	DESCRIPTION
E					REVISED TO ADD PURGE GAS LOCATION
D					REV TO MECHANICAL SEAL
C					ADDED ITEM #26A
B					ADDED ITEM #32
A					ADDED DIMENSION .096

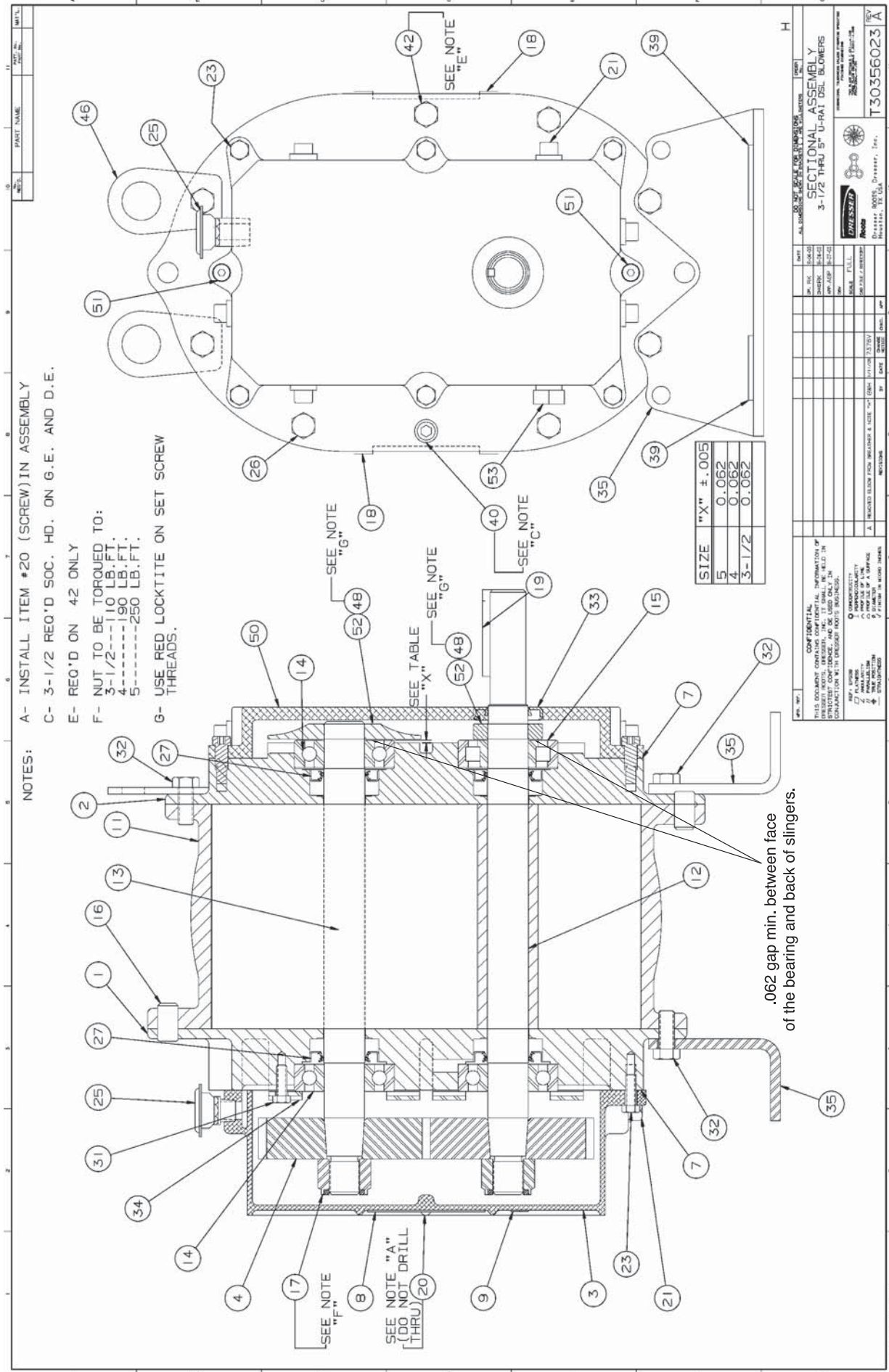
REV.	DATE	BY	CHKD.	APP.	DESCRIPTION
E					REVISED TO ADD PURGE GAS LOCATION
D					REV TO MECHANICAL SEAL
C					ADDED ITEM #26A
B					ADDED ITEM #32
A					ADDED DIMENSION .096

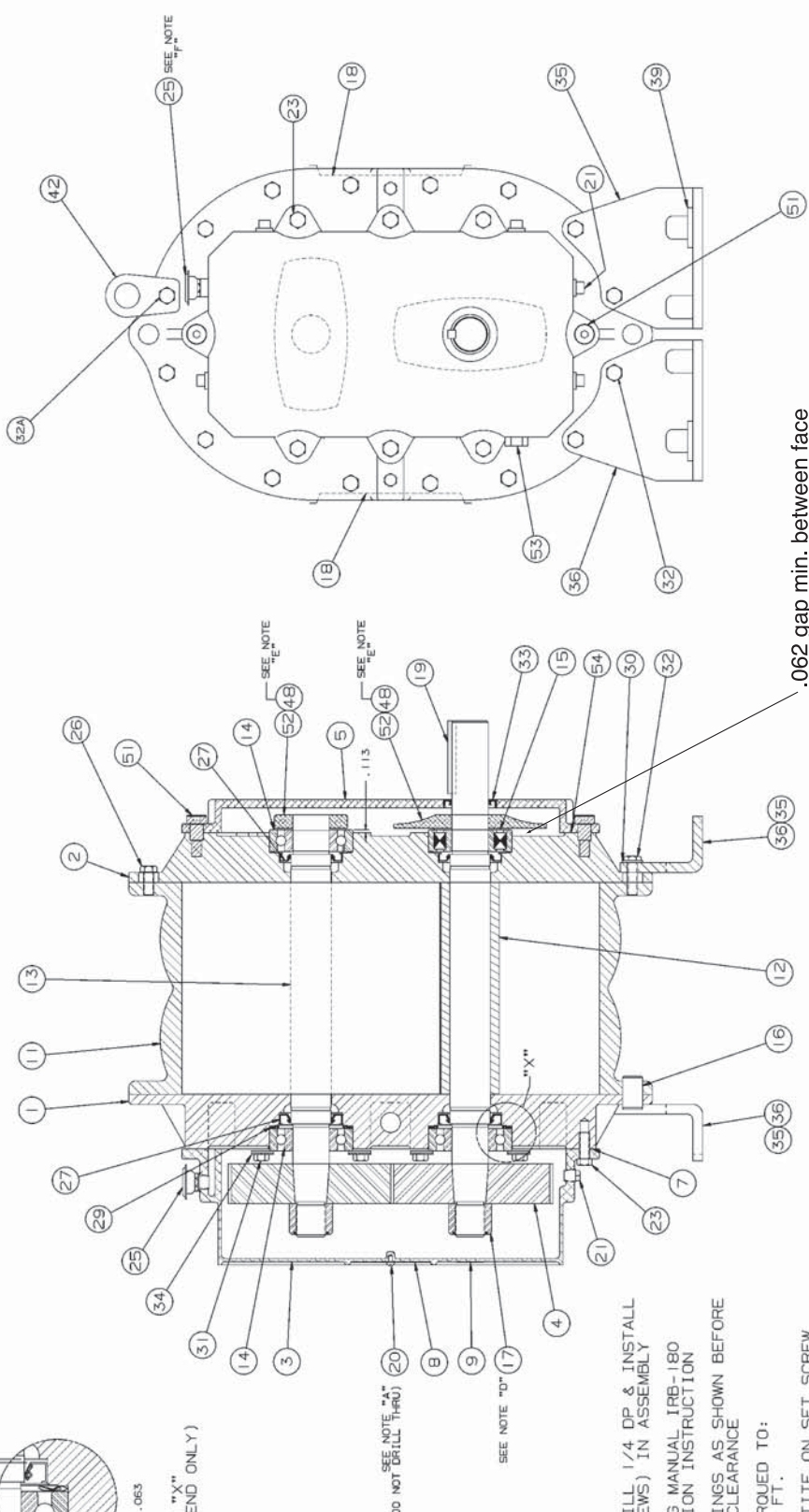
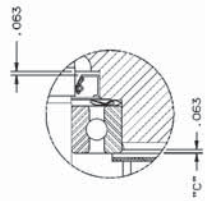
REV.	DATE	BY	CHKD.	APP.	DESCRIPTION
E					REVISED TO ADD PURGE GAS LOCATION
D					REV TO MECHANICAL SEAL
C					ADDED ITEM #26A
B					ADDED ITEM #32
A					ADDED DIMENSION .096

Assembly of UNIVERSAL RAI Series Gas Blowers, 6" Gear Diameter

P:\FILES\COMPANIES\RAI



Assembly of UNIVERSAL RAI Series - DSL with Splash Lubricated Drive End 3-5" Gear Diameter



NOTES

- A #25(.150) DRILL 1/4 DP & INSTALL ITEM 20 (SCREWS) IN ASSEMBLY
- B SEE OPERATING MANUAL IRB-180 FOR LUBRICATION INSTRUCTION
- C INSTALL BEARINGS AS SHOWN BEFORE SETTING END CLEARANCE
- D NUT TO BE TORQUED TO: 6"---400 LB. FT.
- E USE RED LOCKTITE ON SET SCREW THREADS. MUST HAVE .06" CLEARANCE BETWEEN SLINGER & BEARING
- F LOOKING AT THE DRIVE SHAFT END:
  - a) BREATHER MUST BE MOUNTED ON RIGHT SIDE FOR VERTICAL, LEFT OR RIGHT DISCHARGE UNIT
  - b) BREATHER MUST BE MOUNTED ON LEFT SIDE FOR HORIZONTAL, TOP DISCHARGE UNIT

REV. 1000  
 DATE 10/11/10  
 BY 1000  
 CHECKED BY 1000  
 APPROVED BY 1000  
 SECTIONAL ASSEMBLY  
 WITH TAPE  
 DRAWING

REV.	DATE	BY	CHKD.	APP'D.	DESCRIPTION
1000	10/11/10	1000	1000	1000	SECTIONAL ASSEMBLY WITH TAPE DRAWING
1000	10/11/10	1000	1000	1000	SECTIONAL ASSEMBLY WITH TAPE DRAWING
1000	10/11/10	1000	1000	1000	SECTIONAL ASSEMBLY WITH TAPE DRAWING
1000	10/11/10	1000	1000	1000	SECTIONAL ASSEMBLY WITH TAPE DRAWING
1000	10/11/10	1000	1000	1000	SECTIONAL ASSEMBLY WITH TAPE DRAWING

Assembly of UNIVERSAL RAI Series - DSL with Splash Lubricated Drive End 6" Gear Diameter

**Universal RAI Series Blowers Parts List**  
**2-1/2" – 5" Gear Diameter**

(Refer to drawing #64720023)

Item #	Part Name	Qty.
1	Headplate Gear End	1
2	Headplate Drive End	1
3	Gearbox	1
4	Timing Gears	2
5	Cover-Blind (Plug Opening)	1
7	Gasket, Gear Box	1
11	Cylinder	1
12	Impeller & Shaft Drive	1
13	Impeller & Shaft Driven	1
14	Bearing, Ball	3
15	Bearing, Roller	1
16	Pin, Dowel	4
17	Gear Nut	2
19	Key	1
21	Plug, Pipe	3
23	Screw Hex	6
25	Breather (Plug Vent)	1
26	Screw, Hex	*
27	Seal, Lip Bearing	4
31	Screw, Hex, Nylock	4
32	Screw, Hex	6
33	Seal Lip-Drive	1
34	Clamp Plate	2
35	Foot	2
37	Fitting, Grease	2
38	Fitting, Relief	2
39	Washer Mounting	4
40	Screw Socket	2
42	Screw Hex	2

\*Quantities vary by blower.

**Universal RAI Series Blowers Parts List**  
**6" & 7" Gear Diameter**

(Refer to drawing #64792023)

Item #	Part Name	Qty.
1	Headplate Gear End	1
2	Headplate Drive End	1
3	Gearbox	1
4	Timing Gears	2
5	Cover-Blind (Plug Opening)	1
7	Gasket, Gear Box	1
11	Cylinder	1
12	Impeller & Shaft Drive	1
13	Impeller & Shaft Driven	1
14	Bearing, Ball	3
15	Bearing, Roller	1
16	Pin, Dowel	4
17	Gear Nut	2
19	Key	1
21	Plug, Pipe	3
23	Screw Hex Nylock	8
25	Breather (Plug Vent)	1
26	Screw, Hex	*
27	Seal, Lip Bearing	4
29	Washer, Spring Wavy	2
31	Screw, Hex, Nylock	4
32	Screw, Hex	10
33	Seal Lip-Drive	1
34	Clamp Plate	2
35	Foot	2
37	Fitting, Grease	2
38	Fitting, Relief	2
39	Washer Mounting	4

\*Quantities vary by blower.

**Universal RAI-DSL Series Blowers Parts List**  
**3-1/2" – 5" Gear Diameter**

(Refer to drawing #T30356023)

Item #	Part Name	Qty.
1	Headplate Gear End	1
2	Headplate Drive End	1
3	Gearbox	1
4	Timing Gears	2
7	Gasket, Gear Box, DE Cover	1
11	Cylinder	1
12	Impeller & Shaft Drive	1
13	Impeller & Shaft Driven	1
14	Bearing, Ball	3
15	Bearing, Roller	1
16	Pin, Dowel	4
17	Gear Nut	2
19	Key	1
21	Plug, Pipe	3
23	Screw Hex	6
25	Breather (Plug Vent)	1
26	Screw, Hex	*
27	Seal, Lip Bearing	4
31	Screw, Hex, Nylock	4
32	Screw, Hex	6
33	Seal Lip-Drive	1
34	Clamp Plate	2
35	Foot	2
39	Washer Mounting	4
40	Screw Socket	2
42	Screw Hex	2
48	DE Oil Slinger Set Screw	4
50	Drive End Cover	1
52	Drive End Oil Slinger	2
53	Oil Sight Glass	2

\*Quantities vary by blower.

**Universal RAI®-DSL Series Blowers Parts List 6" Gear Diameter**

(Refer to drawing #T30382023)

Item #	Part Name	Qty.	Item #	Part Name	Qty.
1	Headplate Gear End	1	23	Screw Hex Nylock	8
2	Headplate Drive End	1	25	Breather (Plug Vent)	1
3	Gearbox	1	26	Screw, Hex	*
4	Timing Gears	2	27	Seal, Lip Bearing	4
7	Gasket, Gear Box	1	31	Screw, Hex, Nylock	4
11	Cylinder	1	32	Screw, Hex	10
12	Impeller & Shaft Drive	1	33	Seal Lip-Drive	1
13	Impeller & Shaft Driven	1	34	Clamp Plate	2
14	Bearing, Ball	3	35	Foot	2
15	Bearing, Roller	1	39	Washer Mounting	4
16	Pin, Dowel	4	48	DE Oil Slinger Set Screw	4
17	Gear Nut	2	50	Drive End Cover	1
19	Key	1	52	Drive End Oil Slinger	2
21	Plug, Pipe	3	53	Oil Sight Glass	2

\*Quantities vary by blower.

**Universal RAI Series Gas Blowers Parts List**  
**3-1/2" & 5" Gear Diameter**

(Refer to drawing #T30099023)

Item #	Part Name	Qty.
1	Headplate Gear End	1
2	Headplate Drive End	1
3	Gearbox	1
4	Timing Gears	2
5	Cover-Blind (Plug Opening)	1
7	Gasket, Gear Box	1
11	Cylinder	1
12	Impeller & Shaft Drive	1
13	Impeller & Shaft Driven	1
14	Bearing, Ball	3
15	Bearing, Roller	1
16	Pin, Dowel	4
17	Gear Nut	2
19	Key	1
21	Plug, Pipe	3
23	Screw Hex	8
25	Breather (Plug Vent)	1
26	Screw, Hex	14*
27	Seal, Bearing	4
31	Screw, Hex	4
32	Screw, Hex	4
33	Seal Lip-Drive	1
34	Clamp Plate	2
35	Foot	2
37	Fitting, Grease	2
38	Fitting, Relief	2
39	Washer Mounting	4
40	Screw Socket	2
42	Screw Hex	2

\*Quantities vary by blower.

**Universal RAI Series Gas Blowers Parts List**  
**6" Gear Diameter**

(Refer to drawing #T3011023)

Item #	Part Name	Qty.
1	Headplate Gear End	1
2	Headplate Drive End	1
3	Gearbox	1
4	Timing Gears	2
5	Cover-Blind (Plug Opening)	1
7	Gasket, Gear Box	1
7*	Gasket DE Cover	1
11	Cylinder	1
12	Impeller & Shaft Drive	1
13	Impeller & Shaft Driven	1
14	Bearing, Ball	3
15	Bearing, Roller	1
16	Pin, Dowel	4
17	Gear Nut	2
19	Key	1
21	Plug, Pipe	3
23	Screw Hex Nylock	8
25	Breather (Plug Vent)	1
26	Screw, Hex	14**
27	Seal, Bearing	4
31	Screw, Hex	4
32	Screw, Hex	10
33	Seal Lip-Drive	1
34	Clamp Plate	2
35	Foot	2
37	Fitting, Grease	2
38	Fitting, Relief	2
39	Washer Mounting	4
40	Screw Socket	2
42	Screw Hex	2
43	Plug	8
51	Shoulder Bolt	2
53	Oil Sight Glass	2

\*DE cover gasket is not the same as the gasket used on the GE. You must specify the gasket required when ordering.

\*\*Quantities vary by blower.

**Specified Lubricants**

**ROOTS Synthetic Oil: ISO-VG-220 Grade**

	Part Number
Quart	813-106-001
Gallon	813-106-002
Case (12 qts)	813-106-008

**ROOTS Synthetic Oil: ISO-VG-320 Grade**

	Part Number
Quart	813-106-004
Gallon	813-106-005
Case (12 qts)	813-106-007

**ROOTS Synthetic Grease: NLGI #2**

	Part Number
14.5 oz. Tube	T200019-001
5 Gallon Pail	T200019-003
Case (30 tubes)	T200019-002



## Basic Connection & Drive Shaft Information

### UNIVERSAL RAI (URAI) AIR BLOWERS

#### URAI AIR BLOWERS (with Grease Lubricated Drive End)

BOM # *	FRAME SIZE	INLET/DISCH CONN.	SHAFT DIAMETER	BARE WEIGHT
65102020	22	1" NPT	0.625"	32
65103020	24	2" NPT	0.625"	43
71048020	32	1.25" NPT	0.750"	69
65105020	33	2" NPT	0.750"	74
65106020	36	2.5" NPT	0.750"	102
65108020	42	1.5" NPT	0.875"	88
65109020	45	2.5" NPT	0.875"	109
65110020	47	3" NPT	0.875"	128
65112020	53	2.5" NPT	1.125"	143
65113020	56	4" NPT	1.125"	170
65114020	59	4" NPT	1.125"	204
65116020	65	3" NPT	1.375"	245
65117020	68	5" NPT	1.375"	285
65118020	615	6" Flange	1.375"	425
65120020	76	4" NPT	1.562"	400
65121020	711	6" Flange	1.562"	530
65122020	718	8" Flange	1.562"	650

Refer to Specification Sheet S-12K84

#### URAI-DSL AIR BLOWERS (with Dual Splash Lubrication DSL)

BOM # *	FRAME SIZE	INLET/DISCH CONN.	SHAFT DIAMETER	BARE WEIGHT
T30378020	32	1.25" NPT	0.750"	72
T30379020	33	2" NPT	0.750"	77
T30380020	36	2.5" NPT	0.750"	105
T30352020	42	1.5" NPT	0.875"	92
T30353020	45	2.5" NPT	0.875"	113
T30354020	47	3" NPT	0.875"	132
T30359020	53	2.5" NPT	1.125"	148
T30360020	56	4" NPT	1.125"	175
T30361020	59	4" NPT	1.125"	209
T30384020	65	3" NPT	1.375"	250
T30385020	68	5" NPT	1.375"	290
T30386020	615	6" Flange	1.375"	430

Refer to Specification Sheet S-27S03

**Universal RAI** air blowers include detachable mounting feet which permit vertical or horizontal installation. The units are center timed for rotation in either direction. The bearings on the URAI are grease lubricated on the drive end and splash lubricated on the gear end. The URAI-DSL is splash lubricated on BOTH ends.

### UNIVERSAL RAI (URAI) GAS BLOWERS

#### URAI-G™ GAS BLOWERS (with Grease Lubricated Drive End)

BOM # *	FRAME SIZE	INLET/DISCH CONN.	SHAFT DIAMETER	BARE WEIGHT
710480G0	32	1.25" NPT	0.750"	69
651050G0	33	2" NPT	0.750"	74
651060G0	36	2.5" NPT	0.750"	102
651080G0	42	1.5" NPT	0.875"	88
651090G0	45	2.5" NPT	0.875"	109
651100G0	47	3" NPT	0.875"	128
651120G0	53	2.5" NPT	1.125"	143
651130G0	56	4" NPT	1.125"	170
651140G0	59	4" NPT	1.125"	204
651160G0	65	3" NPT	1.375"	245
651170G0	68	5" NPT	1.375"	285
651180G0	615	6" NPT	1.375"	425

Refer to Specification Sheet S-60A01

**Universal RAI-G™** gas blowers include detachable mounting feet which permit vertical or horizontal installation. **Feet are different for vertical and horizontal mounting.**

The units are center timed for rotation in either direction. The bearings on the Universal RAI-GTM are grease lubricated on the drive end and splash lubricated on the gear end. ROOTS Synthetic lubricant is recommended.

**Basic Connection & Drive Shaft Information**

**UNIVERSAL RAI (URAI-J) WHISPAIR AIR BLOWERS**

**URAI-J WHISPAIR AIR BLOWERS (with Grease Lubed Drive End)**

<b>BOM # *</b>	<b>FRAME SIZE</b>	<b>INLET/DISCH CONN.</b>	<b>SHAFT DIAMETER</b>	<b>BARE WEIGHT</b>
74065020	33J	2" NPT	0.750"	84
74086020	36J	2.5" NPT	0.750	112
74066020	45J	2.5" NPT	0.875"	119
74087020	47J	3" NPT	0.875	138
74067020	56J	4" NPT	1.125"	180

Refer to Specification Sheet S-33A93

**URAI-J-DSL WHISPAIR AIR BLOWERS (with Dual Splash Lubrication DSL)**

<b>BOM # *</b>	<b>FRAME SIZE</b>	<b>INLET/DISCH CONN.</b>	<b>SHAFT DIAMETER</b>	<b>BARE WEIGHT</b>
T30417020	33J	2" NPT	0.750"	87
T30418020	36J	2.5" NPT	0.750	115
T30410020	45J	2.5" NPT	0.875"	122
T30412020	47J	3" NPT	0.875	141
T30415020	56J	4" NPT	1.125"	185

Refer to Specification Sheet S-30S03

**URAI-J METRIC WHISPAIR AIR BLOWERS (with Grease Lubed Drive End)**

<b>BOM # *</b>	<b>FRAME SIZE</b>	<b>INLET/DISCH CONN.</b>	<b>SHAFT DIAMETER</b>	<b>BARE WEIGHT</b>
TBD	33J	2" BSP	19 mm	84
740860M0	36J	2.5" BSP	19 mm	112
TBD	45J	2.5" BSP	24 mm	119
TBD	47J	3" BSP	24 mm	138
TBD	56J	4" BSP	28 mm	180

**URAI-J-DSL METRIC WHISPAIR AIR BLOWERS (with Dual Splash Lubrication DSL)**

<b>BOM # *</b>	<b>FRAME SIZE</b>	<b>INLET/DISCH CONN.</b>	<b>SHAFT DIAMETER</b>	<b>BARE WEIGHT</b>
TBD	33J	2" BSP	19 mm	87
T304660M0	36J	2.5" BSP	19 mm	115
TBD	45J	2.5" BSP	24 mm	122
T304550M0	47J	3" BSP	24 mm	141
TBD	56J	4" BSP	28 mm	185

Universal RAI-J air blowers incorporate the patented Whispair™ design in addition to the same features as the original URAI blowers. The URAI-J's are center timed, however the Whispair™ benefits can only be realized when the jet is located in the discharge position.

## Basic Connection & Drive Shaft Information

### UNIVERSAL RAI METRIC (URAI-M) AIR BLOWERS

*NOTE: METRIC URAI product has metric shaft diameter and connection sizes*

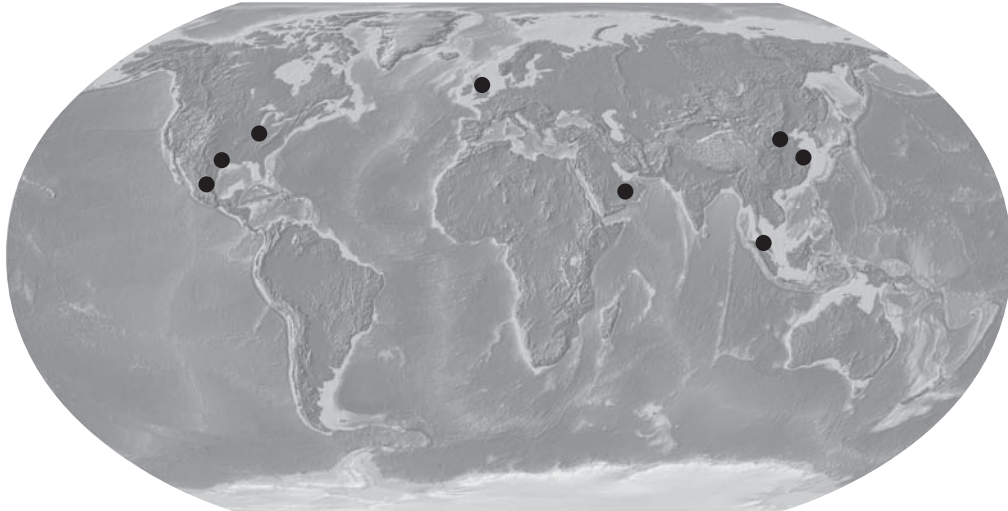
#### URAI-METRIC AIR BLOWERS (with Grease Lubricated Drive End)

BOM # *	FRAME SIZE	INLET/DISCH CONN.	SHAFT DIAMETER	BARE WEIGHT
651020M0	22	1" BSP	16 mm	32
651030M0	24	2" BSP	16 mm	43
710480M0	32	1 1/4" BSP	19 mm	69
651050M0	33	2" BSP	19 mm	74
651060M0	36	2 1/2" BSP	19 mm	102
651080M0	42	1 1/2" BSP	24 mm	88
651090M0	45	2 1/2" BSP	24 mm	109
651100M0	47	3" BSP	24 mm	128
651120M0	53	2 1/2" BSP	28 mm	143
651130M0	56	4" BSP	28 mm	170
651140M0	59	4" BSP	28 mm	204
T30392060	65	3" BSP	32 mm	245
T30394060	68	5" BSP	32 mm	285
T30390060	615	150 NP10	32 mm	425
T30396060	76	4" BSP	38 mm	400
T30398060	711	150 NP10	38 mm	530
T30400060	718	200 NP10	38 mm	650

#### URAI-DSL-METRIC AIR BLOWERS (with Dual Splash Lubrication DSL)

BOM # *	FRAME SIZE	INLET/DISCH CONN.	SHAFT DIAMETER	BARE WEIGHT
T30463060	32	1 1/4" BSP	19 mm	72
T30464060	33	2" BSP	19 mm	77
T30465060	36	2 1/2" BSP	19 mm	105
T30451060	42	1 1/2" BSP	24 mm	92
T30452060	45	2 1/2" BSP	24 mm	113
T30453060	47	3" BSP	24 mm	132
T30459060	53	2 1/2" BSP	28 mm	148
T30460060	56	4" BSP	28 mm	175
T30461060	59	4" BSP	28 mm	209
T30472060	65	3" BSP	32 mm	250
T30473060	68	5" BSP	32 mm	290
T30474060	615	150 NP 10	32 mm	430

**Universal RAI** air blowers include detachable mounting feet which permit vertical or horizontal installation. The units are center timed for rotation in either direction. The bearings on the URAI are grease lubricated on the drive end and splash lubricated on the gear end. The URAI-DSL is splash lubricated on BOTH ends.



## **Dresser Roots Sales**

Houston, TX • Toll Free: 1-877-363-ROOT(S) (7668) • Direct: 832-590-2600

Connersville, IN • Toll Free: 1-877-442-7910 • Direct: 765-827-9305

Huddersfield, UK • Ph: +44 (0) 1484 422 222

Mexico City, Mexico • Ph: +52 55 5889 5811

Dubai, UAE • Ph: +971 4-8830831

Kuala Lumpur, Malaysia • Ph: +60 3 2163 0480

Beijing, China • Ph: +86 10 8486 2440

## **Dresser Roots Factory Service & Repair**

Houston, TX • Ph: 713-896-4810

Connersville, IN • Ph: 765-827-9200

Huddersfield, UK • Ph: +44 (0) 1484 487 669

Mexico City, Mexico • Ph: +52 55 5889 5811

Dubai, UAE • Ph: +971 4-8830831

Shanghai, China • Ph: +86 21 5858 7638



**Roots**

### **Headquarters**

16240 Port Northwest Drive  
Houston, TX 77041  
Toll Free (US): 1-877-363-7668  
Ph: 832-590-2305  
Toll Free Fax: 1-877-357-7238  
Fx: 832-590-2326

### **Connersville Operations**

900 West Mount Street  
Connersville, IN 47331  
Ph: 765-827-9200  
Fx: 765-827-9266

### **Huddersfield Operations**

PO Box B7  
Off St. Andrews Rd  
Turnbridge, Huddersfield  
England HD1 6RB  
Ph: +44 (0) 1484 422 222  
Fx: +44 (0) 1484 423 429