

M
QP **MPPARTS**
MIXER & PLANT PARTS MFG, LLC

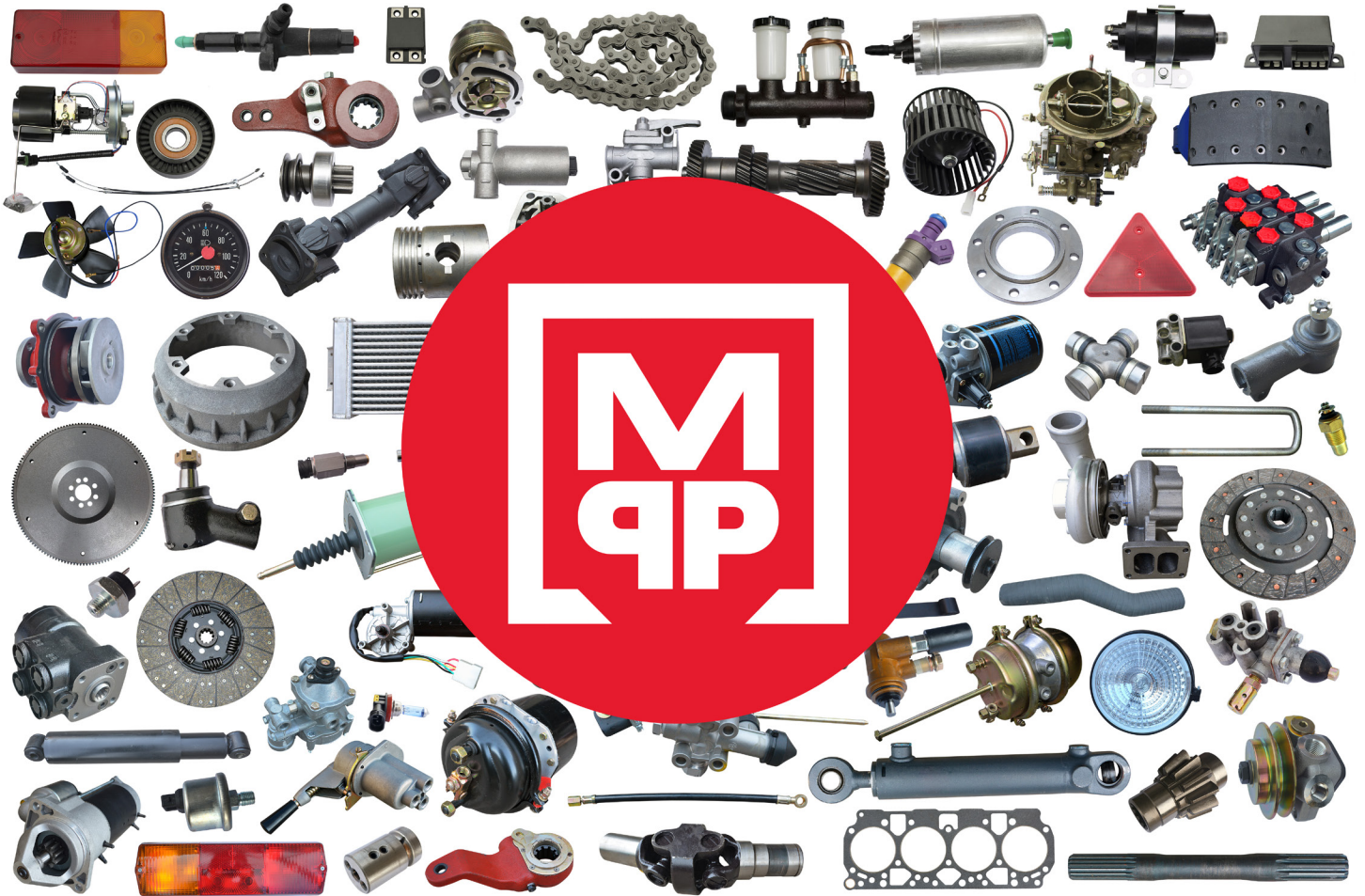

REAR DISCHARGE MIXER PARTS

2024



CALL (800) 607-9837
FAX (586) 601-1904



WWW.MPPARTS.COM



1843 TUCKER STREET
ROCK HILL, SC 29730





I know how frustrating it can be to have a mixer truck or a concrete plant down. As changes take place in the ready mix concrete industry, you have enough headaches finding mixer technicians and truck drivers. At Mixer & Plant Parts, we understand you want to speak with knowledgeable people who know concrete batch plants and front discharge concrete mixer trucks and how important it is for the right parts to show up at your operation on time every time.

You've probably tried to call and place orders with large corporations and wonder if the person on the other end of the phone even understands what you are asking for. You may have even wondered if they even care about you as a human being.

Well, we've built Mixer & Plant Parts to deliver the peace of mind you need and to stay "Ready Mix Tough" when customer service is weakening all around you. We've built a "Ready Mix Tough" team who is:

- For YOU
- For Each Other
- For the Community - AND -
- For Making a Difference in the World

Meet Jake, Marc, and John who manage the excellent teams in our distribution centers in Grand Rapids, MI, Arlington, TX, and Rock Hill, SC and ensure your parts are assembled, picked, packed and shipped with extraordinary care.

Meet Jamie, the manager of our amazing sales team who have years of experience in the ready mix concrete and heavy duty trucking industry and are here to guide you to the right parts and deliver the peace of mind you and your company deserves. These folks are phenomenal at guiding customers to the right parts for their front discharge mixers, rear discharge mixers, and heavy duty trucks

I'm also pleased to introduce Dan, leading a great team in our accounting department who work with your owners and bookkeepers to align our books and to deliver your invoices and statements on time every time.

Also please say hello to our operations, development, marketing, and information technology teams with Hannah, Mandy, Andrew, and myself - who are dedicated to leading our continually MProving organization with generosity and Love...yep...I said Love. Our goal is that in every interaction with MPParts, you'll feel a sense of belonging, recognition, peace of mind and receive an incredibly remarkable experience you can't wait to tell your friends and family about.

A handwritten signature in black ink that reads "Brandon Syler". The signature is fluid and cursive, with a large, sweeping initial 'B'.

Brandon Syler - CEO, MPParts
brandon@mpparts.com

WEIGHTS AND MEASURES

| UNIT | MAY BE SEEN AS |
|----------------|----------------|
| Feet | Foot, Ft, ‘ |
| Gallon | Gal |
| Gigabytes | Gigs, Gbs, GB |
| Holes | Hls, HL |
| Inches | In, “ |
| Inner Diameter | ID |
| Leafs | Lf |
| Length | L, lgth, Long |
| Liters | L, Ltrs |
| Millimeters | mm |
| Ounces | Oz |
| Outer Diameter | OD |
| Pieces | Pc, Pcs |
| Pounds | lbs |
| Quart | qt |
| Threads | Thrd |
| Tons | tonne |
| Voltage | V |
| Watts | W |

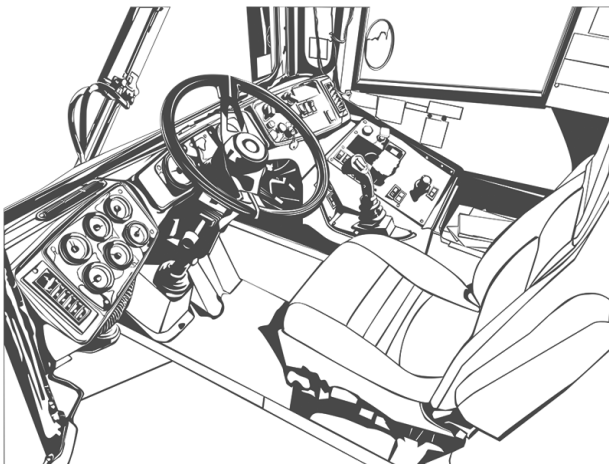

**LH/RH is always from driver perspective.
So LH = roadside and RH = curbside**

.....

**Left Side can be seen as:
Left Side, LS, Left Hand, LH, Roadside, RDSD**

.....

**Right Side can be seen as:
Right Side, RS, Right Hand, RH, Curbside, CBSD**

FRONT PEDESTAL ORDER SPEC SHEET

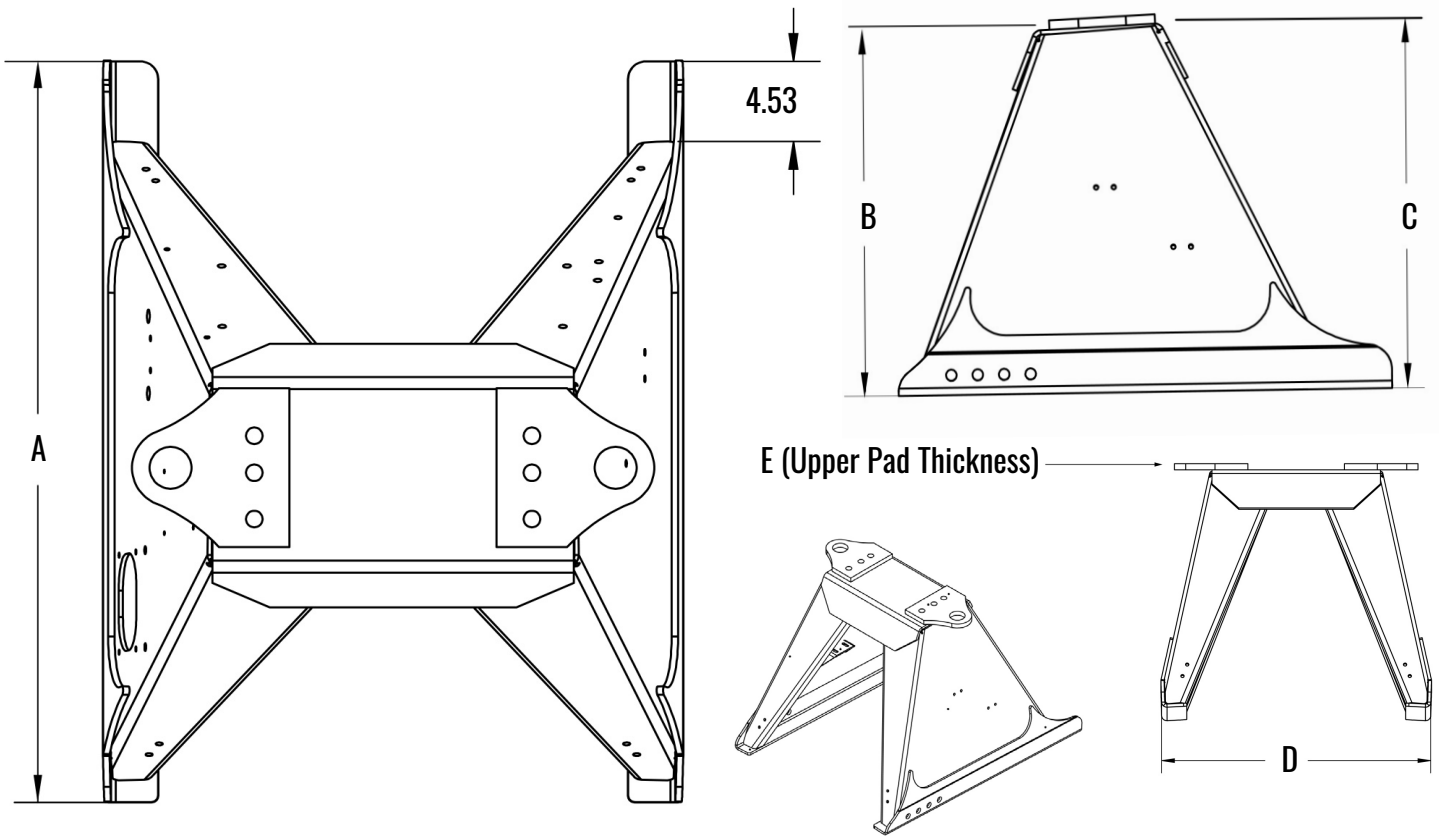

Part # _____

DIMENSIONS

A _____

B _____

C _____

D _____

E _____

Sales Person _____

Mixer Size _____

Unit # _____

Customer Name _____

Street Address _____

City _____

State _____

Zip Code _____

Contact Person _____

REAR PEDESTAL ORDER SPEC SHEET

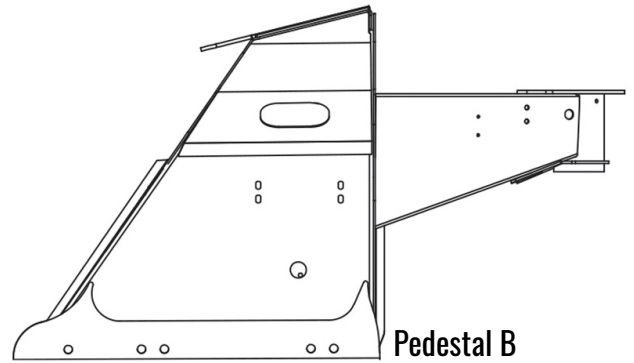
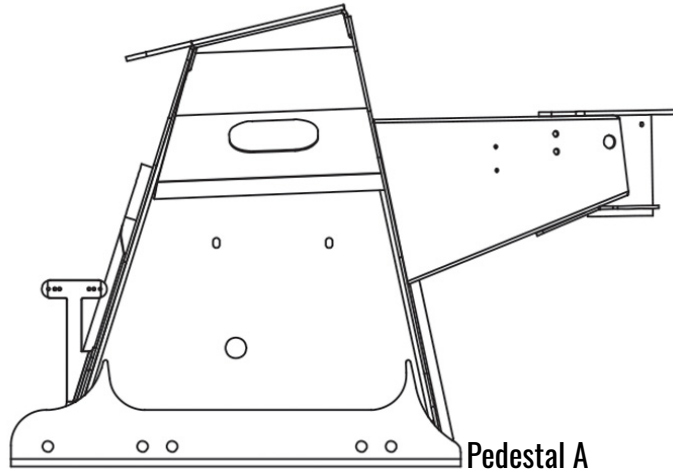
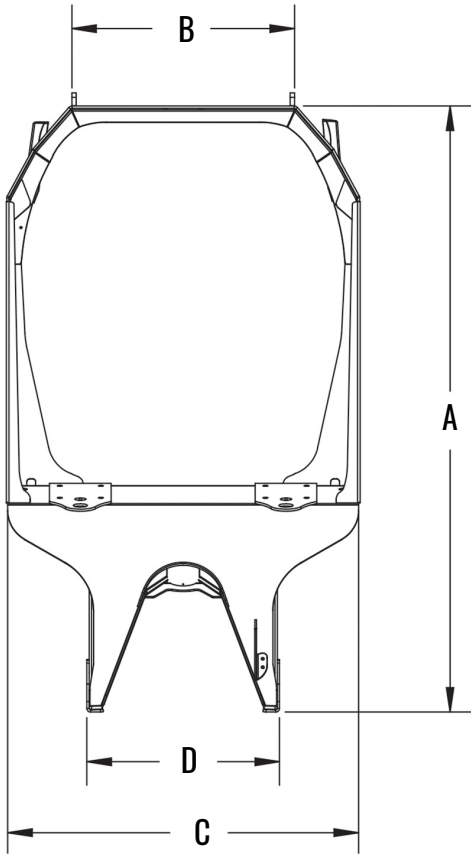

Part # _____

DIMENSIONS

A _____

B _____

C _____

D _____

Options:

Pedestal A:

Pedestal B:

Sales Person _____

Mixer Size _____

Unit # _____

Customer Name _____

Street Address _____

City _____

State _____

Zip Code _____

Contact Person _____



www.mpparts.com 1.800.881.1843

BECK MAIN CHUTES

| PART # | DESCRIPTION | LINK |
|--------|-------------|------|
|--------|-------------|------|

40300H Main Chute with Hydraulic Foldover [link](#)

40565



| PART # | DESCRIPTION | LINK |
|--------|-------------|------|
|--------|-------------|------|

40565 Main Chute Assembly [link](#)



67012

| PART # | DESCRIPTION | LINK |
|--------|-------------|------|
|--------|-------------|------|

67012 Hydraulic Fold-Over Chute Cylinder [link](#)



4056501L

| PART # | DESCRIPTION | LINK |
|--------|-------------|------|
|--------|-------------|------|

4056501L 59in x 32.75in Main Chute Liner [link](#)



67014

| PART # | DESCRIPTION | LINK |
|--------|-------------|------|
|--------|-------------|------|

67014 Hydraulic Assist Cylinder Connector Plate [link](#)



| PART # | DESCRIPTION | LINK |
|--------|-------------|------|
|--------|-------------|------|

67016 Hydraulic Assist Fold-over Crank Arm [link](#)

BECK FOLD-OVER CHUTES

| PART # | DESCRIPTION | LINK |
|--------|------------------------|----------------------|
| 41000 | Transitional Fold-Over | link |
| 41000L | Liner for 41000 | link |

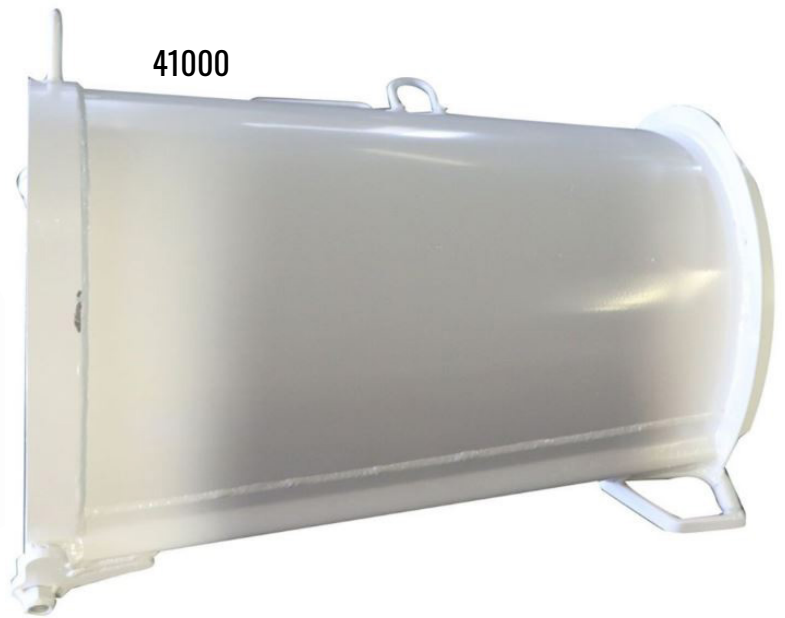
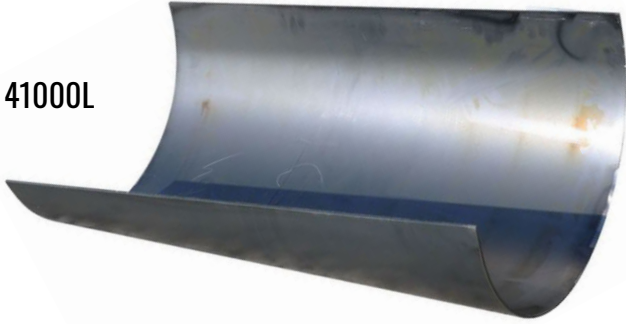

| PART # | DESCRIPTION | LINK |
|--------|-----------------------------------|----------------------|
| 41000H | Foldover Chute for Hydraulic Flip | link |

| PART # | DESCRIPTION | LINK |
|--------|----------------------|----------------------|
| 41300 | Foldback Chute-Paver | link |



| PART # | DESCRIPTION | LINK |
|--------|-----------------------------------|----------------------|
| 41319 | 19in Foldback Chute-Paver (Short) | link |

BECK FOLD-OVER CHUTES

| PART # | DESCRIPTION | LINK |
|--------|-------------|------|
|--------|-------------|------|

47660 Black Rock Blocker Assembly [link](#)



| PART # | DESCRIPTION | LINK |
|--------|-------------|------|
|--------|-------------|------|

47661 Black Rock Blocker Insert [link](#)

47671 Orange Rock Blocker Insert [link](#)

| PART # | DESCRIPTION | LINK |
|--------|-------------|------|
|--------|-------------|------|

47760 Chute Rock Blocking Kit with Lock [link](#)

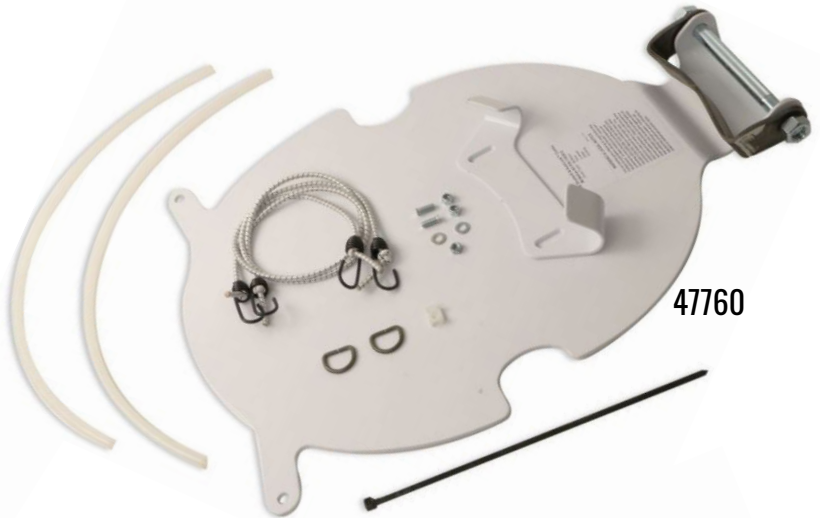

42000

| PART # | DESCRIPTION | LINK |
|--------|-------------|------|
|--------|-------------|------|

42000 4ft Steel Extension Chute [link](#)

42000L 4ft Steel Extension Chute Liner [link](#)

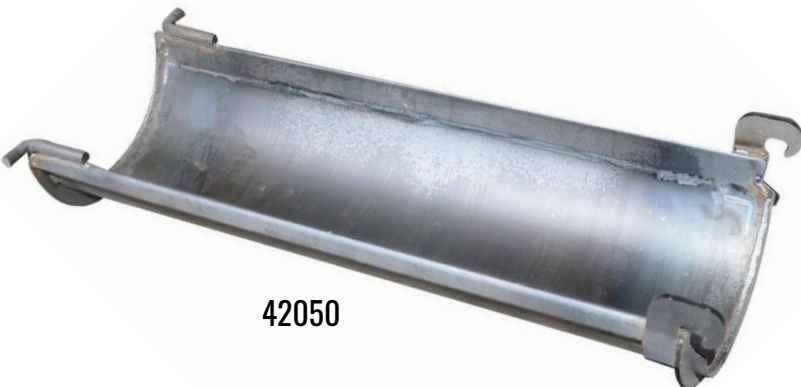

| PART # | DESCRIPTION | LINK |
|--------|-------------|------|
|--------|-------------|------|

42050 16 Gallon Lightweight Extension Chute [link](#)

BECK FOLD-OVER CHUTES

| PART # | DESCRIPTION | LINK |
|----------|--------------------------|----------------------|
| 42000ALH | Aluminum Extension Chute | link |
| 42000AL | Standard Aluminum Liners | link |

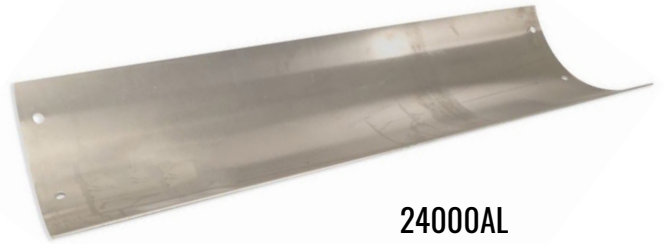

| PART # | DESCRIPTION | LINK |
|--------|-----------------------------------|----------------------|
| 42350 | 49in Transitional Extension Chute | link |



| PART # | DESCRIPTION | LINK |
|--------|-----------------------------------|----------------------|
| 42300 | 49in Transitional Extension Chute | link |

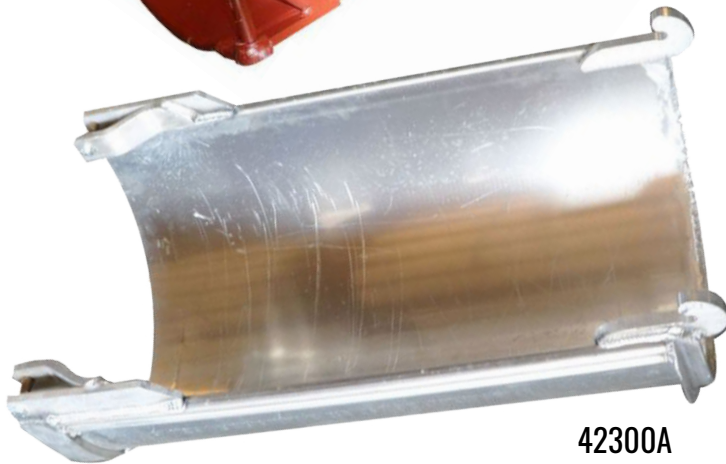

| PART # | DESCRIPTION | LINK |
|--------|--------------------------------|----------------------|
| 42300A | Aluminum Paver Extension Chute | link |



| PART # | DESCRIPTION | LINK |
|--------|-----------------------|----------------------|
| 46450 | Chute Hanger Weldment | link |

CONTINENTAL STANDARD CHUTES

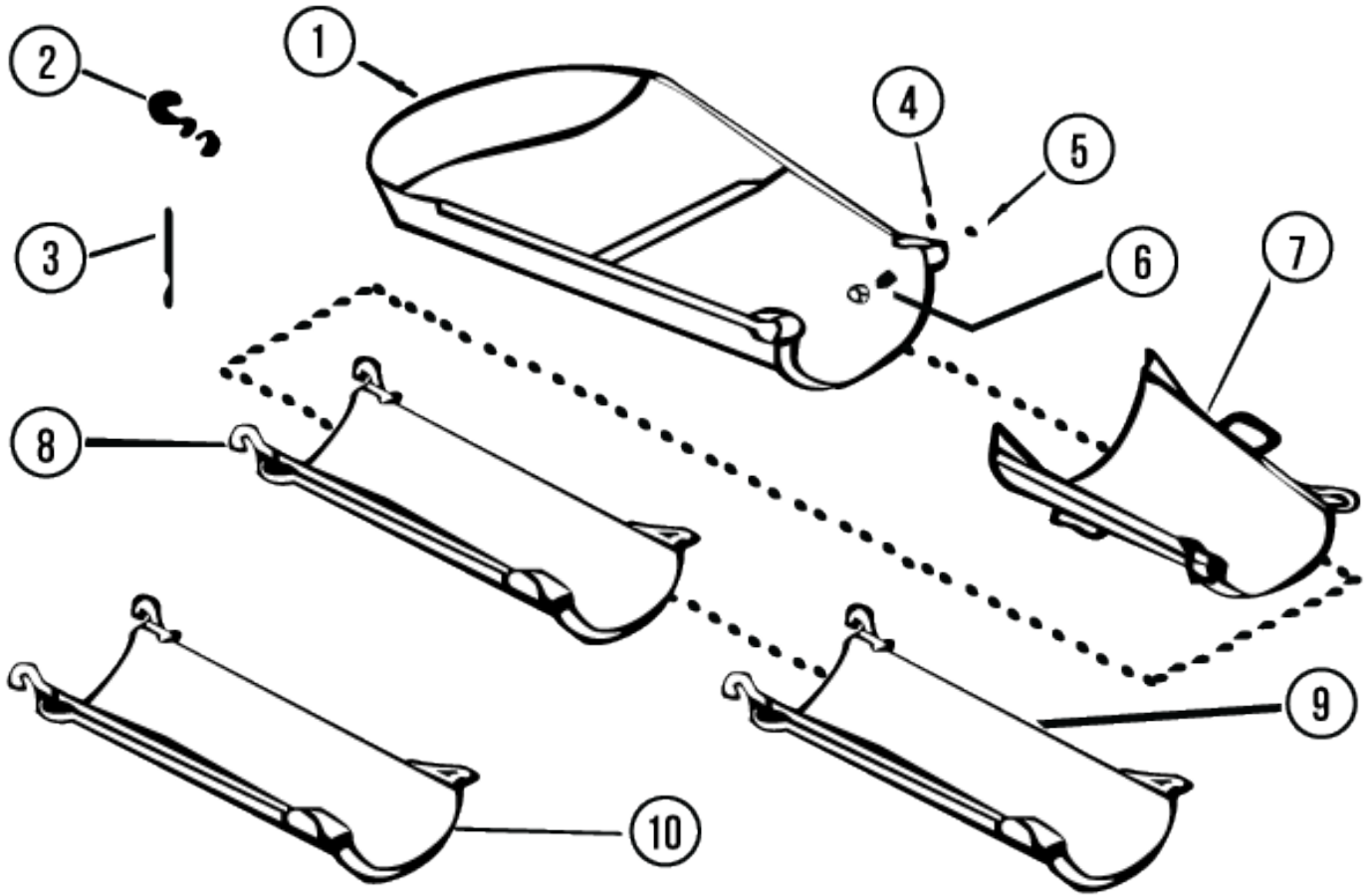

| ITEM | PART # | QTY. | DESCRIPTION | LINK |
|------|-----------|------|--|----------------------|
| 1 | 90512820 | 1 | Standard Main Chute | link |
| 3 | 10500010 | 1 | Main Chute Mounted Latch System | link |
| 5 | 37276 | 2 | 7/8in-9 UNC Nut | link |
| 6 | 15417 | 2 | 7/8in-9 x 3.5in UNC Grade 8 Bolt | link |
| 7 | 90522495 | 1 | Standard 30in Fold Over Chute | link |
| 7A | 90522595 | 1 | Standard 24in Fold Over Chute | link |
| 7B | 90522695 | 1 | Standard 36in Fold Over Chute | link |
| 8-10 | 10530092 | 2 | 14 Gage 48in Extension Standard Chute | link |
| -- | 10539216 | 2 | 16 Gage 48in Extension Standard Chute | link |
| -- | 10530192 | 2 | Standard Aluminum 48in Extension | link |
| -- | 10530092L | 1 | Universal Steel Extension Chute Liner | link |
| -- | 10530192L | 1 | Universal Aluminum Extension Chute Liner | link |

CONTINENTAL STANDARD CHUTES

| PART # | DESCRIPTION | LINK |
|----------|-----------------------------|----------------------|
| 90532300 | Steel Paver Extension Chute | link |



90532300



90520108

| PART # | DESCRIPTION | LINK |
|----------|---------------------------------------|----------------------|
| 90520108 | New Style Loop & Hook Paver Fold Back | link |

| PART # | DESCRIPTION | LINK |
|----------|------------------------------|----------------------|
| 90522595 | Standard 24in Foldback Chute | link |



90522595

| PART # | DESCRIPTION | LINK |
|----------|------------------------------|----------------------|
| 90522695 | Standard 36in Foldback Chute | link |



90522695

| PART # | DESCRIPTION | LINK |
|----------|----------------------------|----------------------|
| 90532392 | Transition Extension Chute | link |



90532392

CONTINENTAL ROCK BLOCKER

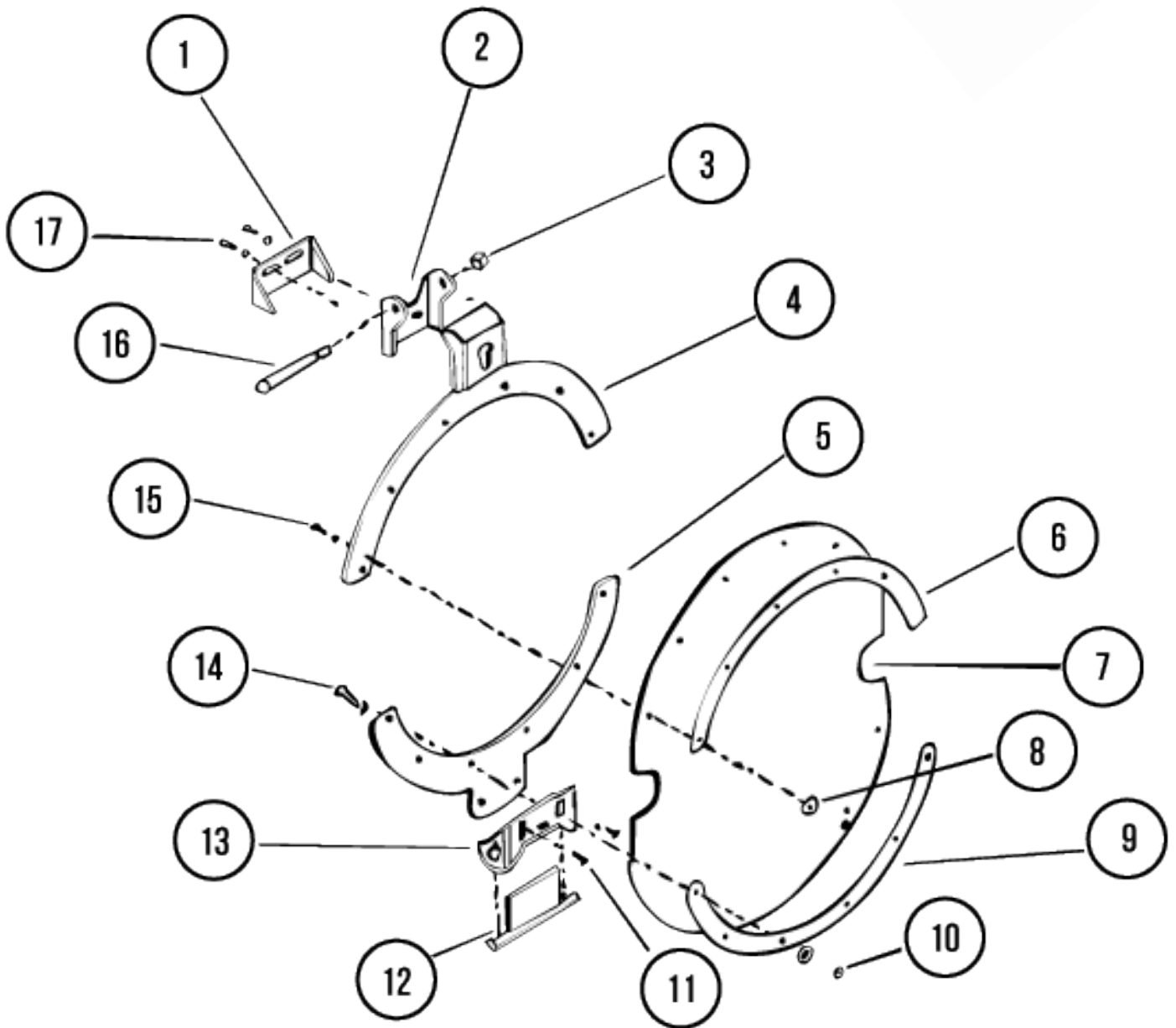

CONTINENTAL ROCK BLOCKER



90500261



80500261

| ITEM | PART # | DESCRIPTION | LINK |
|------|----------|--|----------------------|
| 1 | 90500281 | Rock Blocker Weldment Bracket Hinge | link |
| 2 | 90500282 | Rock Blocker Hinge Adjustment Bracket | link |
| 3 | 37030 | 1/2in x 13 Grade 2 Nylock Hex Lock Nut with Nylon Insert | link |
| 4 | 90500262 | Upper Rock Blocker Bracket | -- |
| 5 | 90500263 | Lower Rock Blocker Bracket | -- |
| 6 | 90500268 | Top Backing Plate | -- |
| 7 | 80500261 | MTM Version Rock Blocker Insert | link |
| 7A | 90500261 | Continental & Rex Version Rock Blocker Insert | link |
| 8 | 33813 | 1/4in SAE Flat Washer | link |
| 9 | 90500269 | Bottom Backing Plate | -- |
| 10 | 37183 | 1/4in 20 Nylock Nut | -- |
| 11 | 15105 | 3/8-16x1in Grade 8 Hex Head Cap Screw | -- |
| 12 | 90500264 | Rock Blocker Latch Pin | link |
| 13 | 90500267 | Rock Blocker Latch Hook | link |
| 14 | 33813 | 1/4in SAE Flat Washer | -- |
| 15 | 21802 | 1/4-20x1in Carriage Bolt | -- |
| 16 | 15223 | 1/2-30x5in Grade 8 Hex Head Cap Screw Bolt | -- |
| 17 | 15105 | 3/8-16x1in Grade 8 Hex Head Cap Screw Bolt | -- |

CON-TECH CHUTES



225001

| PART # | DESCRIPTION | LINK |
|---------|---------------------------|----------------------|
| 225001 | 4ft Steel Extension Chute | link |
| 225001L | Liner for 225001 | link |

| PART # | DESCRIPTION | LINK |
|---------|--------------------------|----------------------|
| 770067 | Aluminum Extension Chute | link |
| 770067L | Liner for 770067 | link |



770066

| PART # | DESCRIPTION | LINK |
|--------|-----------------------------|----------------------|
| 770066 | Lightweight Extension Chute | link |



225053

| PART # | DESCRIPTION | LINK |
|--------|-----------------------------------|----------------------|
| 225053 | 49in Transitional Extension Chute | link |



225051

| PART # | DESCRIPTION | LINK |
|--------|-----------------------------|----------------------|
| 225051 | Steel Paver Extension Chute | link |



225181

| PART # | DESCRIPTION | LINK |
|---------|---------------------|----------------------|
| 225181 | Main Chute Assembly | link |
| 225181L | Liner for 225181 | link |



225049

| PART # | DESCRIPTION | LINK |
|--------|----------------------|----------------------|
| 225049 | Foldback Chute-Paver | link |

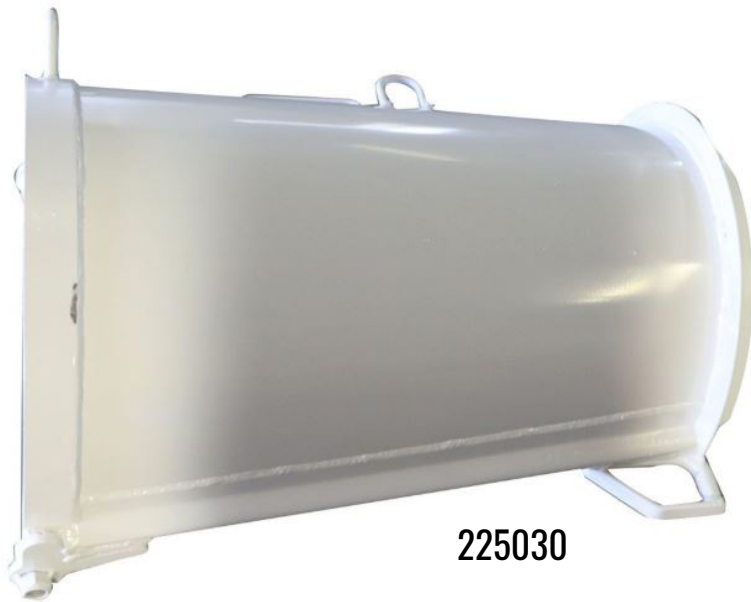

225030

| PART # | DESCRIPTION | LINK |
|---------|---------------------------|----------------------|
| 225030 | Fold Back Flip Over Chute | link |
| 225030L | Liner for 225030 | link |

| PART # | DESCRIPTION | LINK |
|--------|----------------------------|----------------------|
| 225076 | Short Foldback Chute-Paver | link |



CHUTE RACK CABLES

| PART # | DESCRIPTION | LINK |
|--------|-------------------------|----------------------|
| 780001 | 30in Chute Rack Cable | link |
| 780002 | 38.5in Chute Rack Cable | link |
| 780003 | 47.5in Chute Rack Cable | link |
| 780004 | 51in Chute Rack Cable | link |



215958

| PART # | DESCRIPTION | LINK |
|--------|---|----------------------|
| 215958 | 3 Chute Hanger for Aluminum Chutes on the Rear Pedestal | link |



215092

| PART # | DESCRIPTION | LINK |
|--------|-------------------------------------|----------------------|
| 215092 | Chute Stop for Rear Pedestal Hanger | link |



225176

| PART # | DESCRIPTION | LINK |
|--------|------------------------------|----------------------|
| 225176 | Rock Blocker - Stone Stopper | link |



225161

| PART # | DESCRIPTION | LINK |
|--------|---|----------------------|
| 225161 | Universal Rock Blocker Rubber Insert Cover - Orange | link |

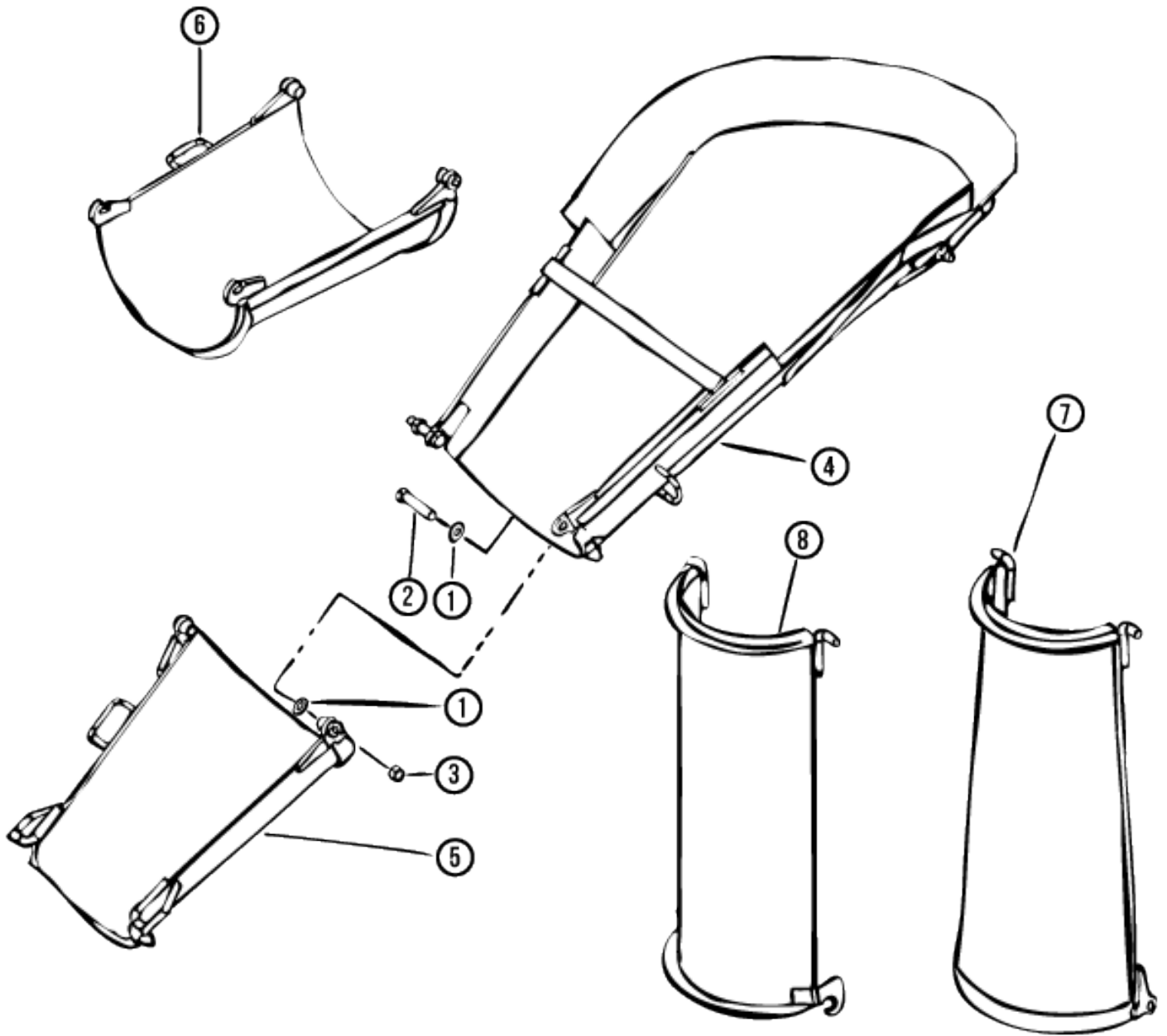

| ITEM | PART # | DESCRIPTION | LINK |
|------|--------|---------------------------------------|----------------------|
| 8 | 18821 | Standard Steel Extension Chute | link |
| -- | 18821L | Universal Steel Extension Chute Liner | link |
| -- | 27360 | Lightweight Extension Chute | link |
| -- | 28393 | Aluminum Extension Chute | link |
| -- | 28393L | Standard Aluminum Liners | link |

FRAME MOUNTED VERTICAL CHUTE RACK STANDARD CHUTES ONLY

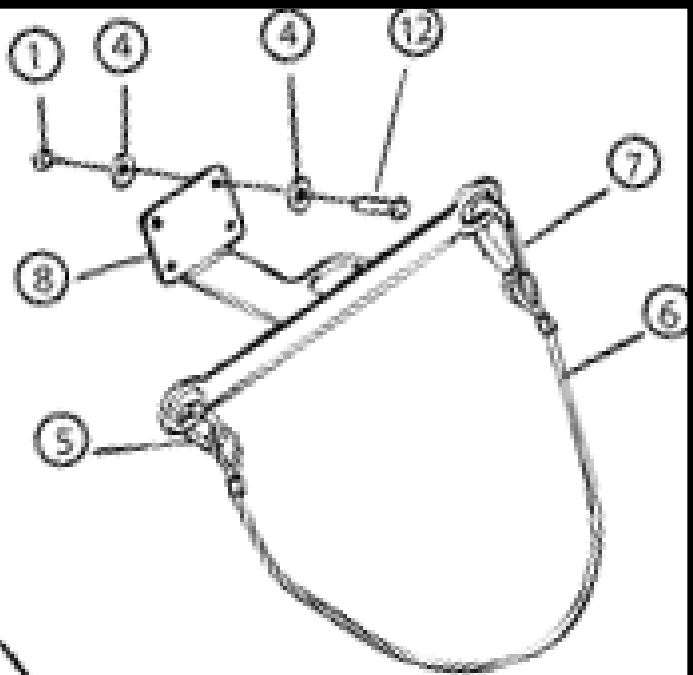
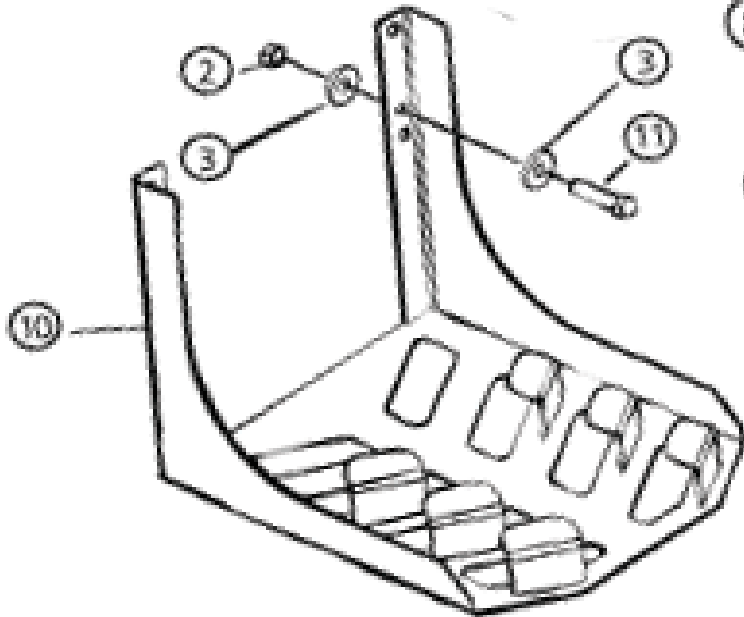

REAR PEDESTAL MOUNTED CHUTE HANGER

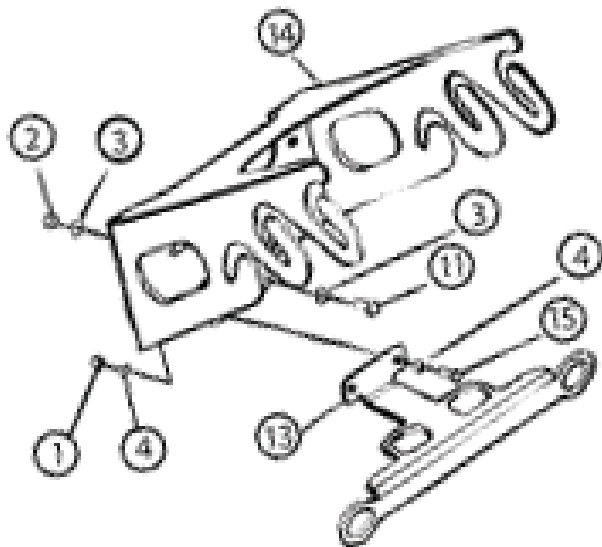
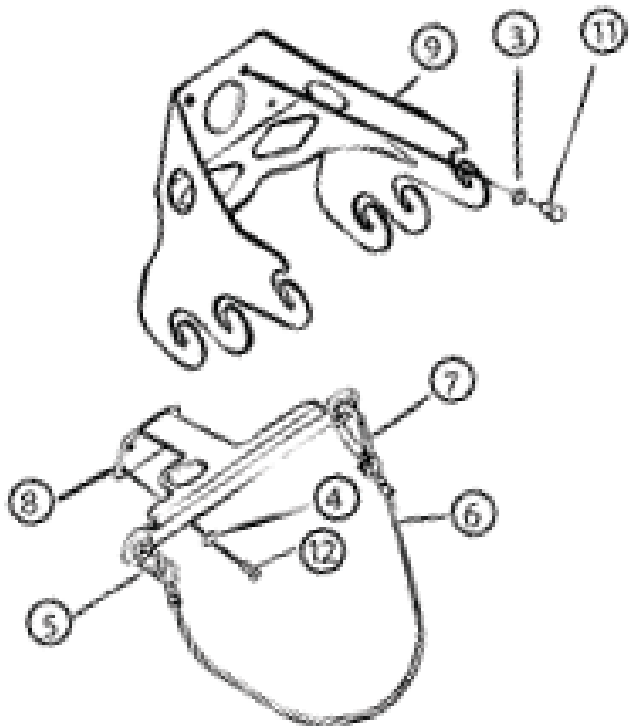

| ITEM | PART # | DESCRIPTION | LINK |
|------|--------|-------------|------|
|------|--------|-------------|------|

| | | | |
|---|-------|------------|----------------------|
| 8 | 21513 | Chute Rack | link |
|---|-------|------------|----------------------|

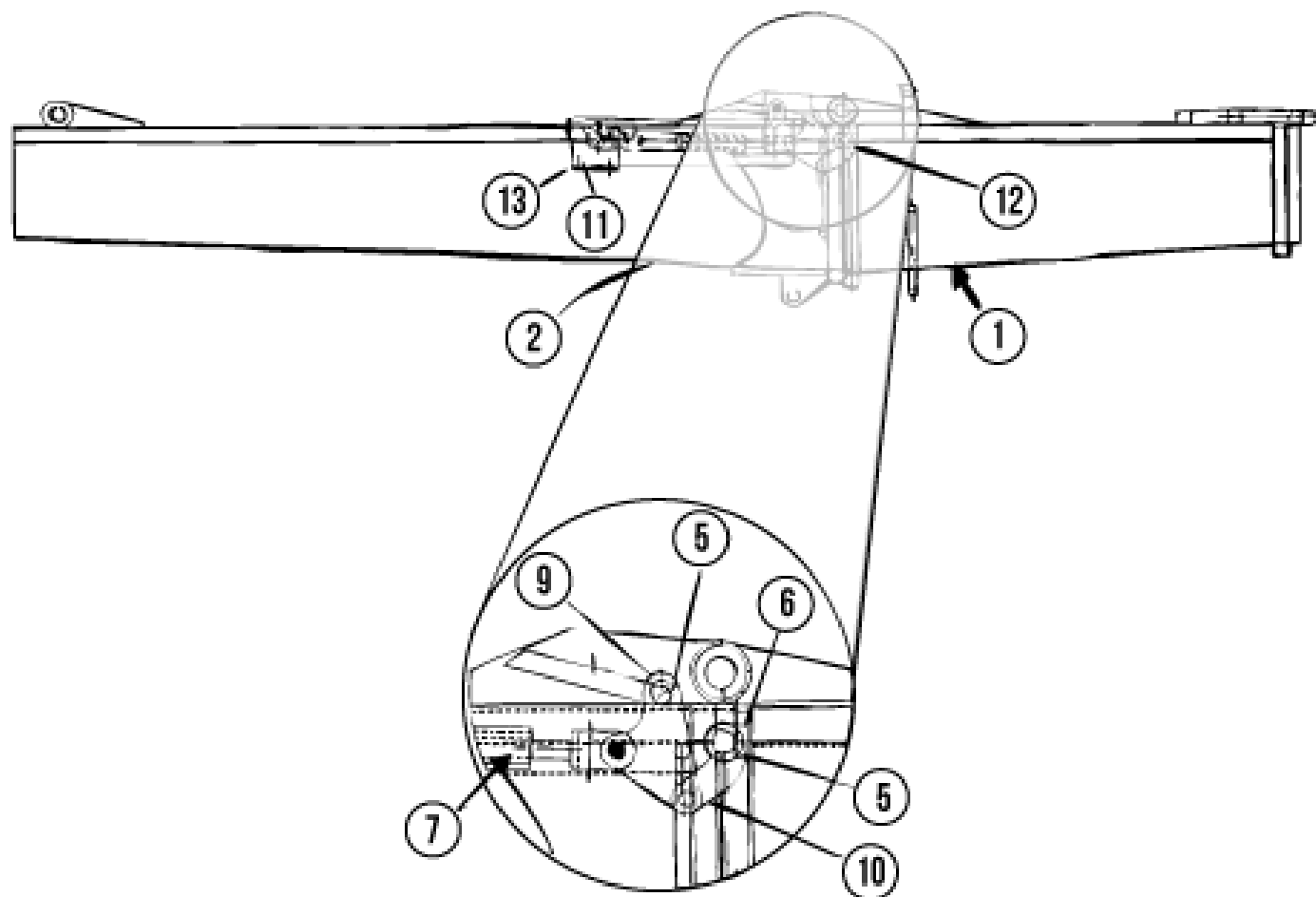

| ITEM | PART # | DESCRIPTION | LINK |
|------|------------|-------------------------------------|----------------------|
| 1 | S0200AA000 | Mixer Foldback Chute - Tapered Flip | link |
| 2 | S0100AB000 | Main Chute | link |

KIMBLE CHUTES

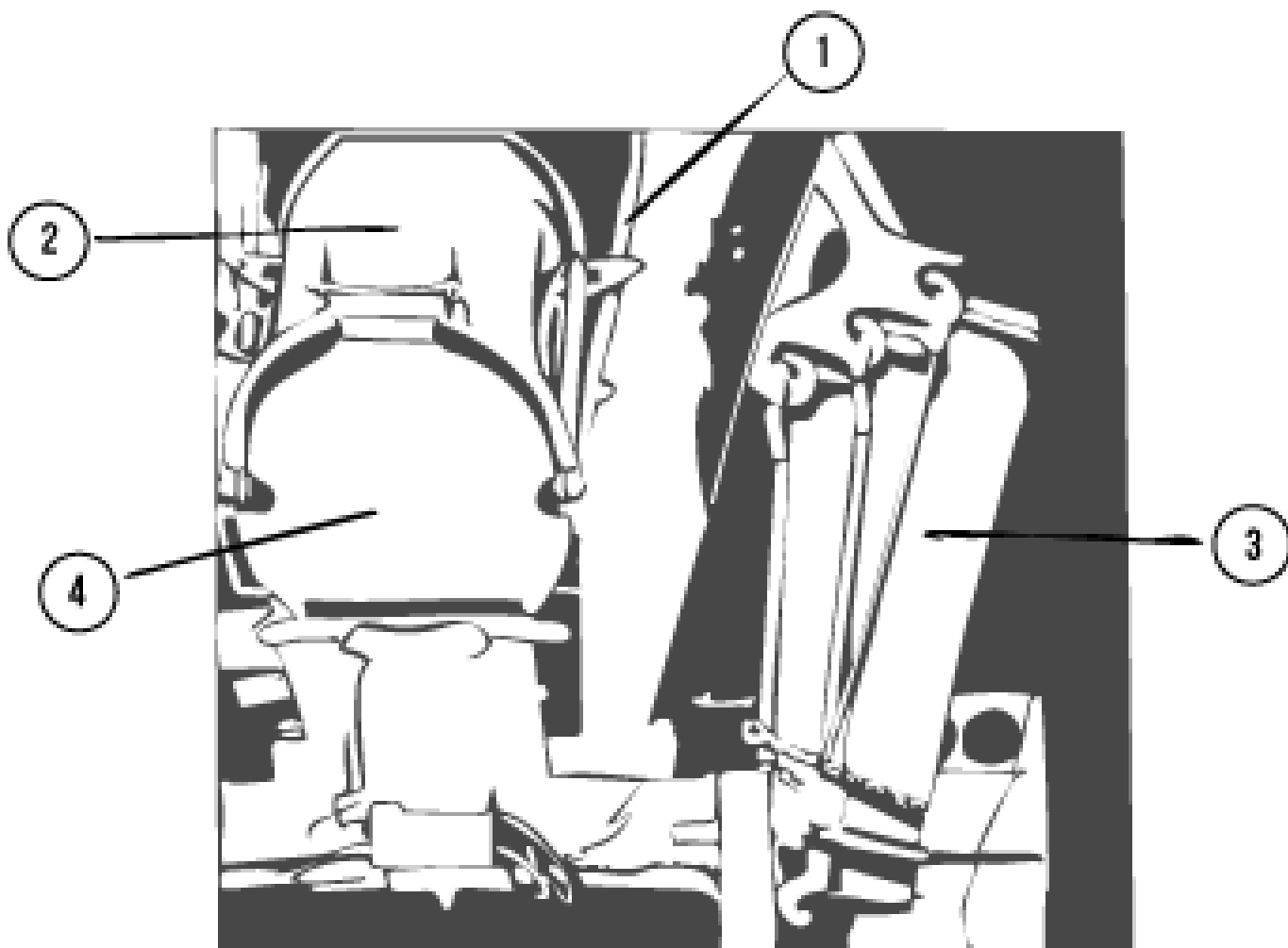

| ITEM | PART # | QTY | DESCRIPTION | LINK |
|------|-------------|-----|---------------------------------------|----------------------|
| Ref | S0100BH000 | | Main and Fold Over Chute Assembly | link |
| 1 | S0100AB000 | 1 | Main Chute | link |
| | S0200AA000 | AR | Mixer Foldback Chute | link |
| 3 | S022013800 | AR | Extension Chute | link |
| | S022013800L | AR | Universal Steel Extension Chute Liner | link |
| Ref | S022014000 | AR | Aluminum Extension Chute | link |
| Ref | S022014100 | AR | Aluminum Standard Extension Chute | link |
| | S022014100L | AR | Aluminum Extension Chute Liner | link |



MC37811

| PART # | DESCRIPTION | LINK |
|----------|--------------------------------|----------------------|
| MC37811 | Aluminum Extension Chute | link |
| MC37811L | Aluminum Extension Chute Liner | link |



MC22473

| PART # | DESCRIPTION | LINK |
|----------|-----------------------------|----------------------|
| MC22473 | Extension Chute | link |
| MC22473L | Steel Extension Chute Liner | link |



MC38974

| PART # | DESCRIPTION | LINK |
|---------|----------------------------|----------------------|
| MC38974 | Super Paver Foldback Chute | link |

| PART # | DESCRIPTION | LINK |
|---------|---------------------------|----------------------|
| MC38856 | Main Chute | link |
| MC24544 | Foldback/ Foldover Chute | link |
| MC37822 | Transition Foldback Chute | link |
| MC38839 | Super Paver Main Chute | link |

015625



| PART # | DESCRIPTION | LINK | PART # | DESCRIPTION | LINK |
|----------|---|----------------------|---------|------------------|----------------------|
| 0153585* | '93-'96 Main Chute *12in longer than 0152625 | link | 0152625 | Main Chute | link |
| | | | 0150594 | Liner for 015625 | link |



0152630



0151600

| PART # | DESCRIPTION | LINK | PART # | DESCRIPTION | LINK |
|---------|---------------------------|----------------------|---------|---------------------|----------------------|
| 0152630 | Fold Back Flip Over Chute | link | 0151600 | 36in Foldback Chute | link |
| 152630L | Liner for 0152630 | link | | | |



0082320

| PART # | DESCRIPTION | LINK |
|---------|-----------------------|----------------------|
| 0082320 | Foldback Chute/ Paver | link |

| PART # | DESCRIPTION | LINK |
|---------|-------------|----------------------|
| 0151690 | End Chute | link |



0151650



1225256

| PART # | DESCRIPTION | LINK |
|---------|----------------------------|----------------------|
| 0151650 | Std. Steel Extension Chute | link |
| 0005020 | Liner for 0151650 | link |

| PART # | DESCRIPTION | LINK |
|---------|---------------------|----------------------|
| 1225256 | 18in Foldback Chute | link |
| 1142700 | Liner for 1225256 | link |



0151665



0082300

| PART # | DESCRIPTION | LINK |
|---------|--------------------------|----------------------|
| 0151665 | Ltweight Extension Chute | link |
| 1107493 | 4ft Al. White Ext. Chute | link |

| PART # | DESCRIPTION | LINK |
|---------|----------------------------|----------------------|
| 0082300 | 48in Steel Extension Chute | link |



0151660



0082315

| PART # | DESCRIPTION | LINK |
|---------|-------------------------|----------------------|
| 0151660 | 49in Transitional Chute | link |

| PART # | DESCRIPTION | LINK |
|---------|--------------------------|----------------------|
| 0082315 | Aluminum Extension Chute | link |



0002063

| PART # | DESCRIPTION | LINK |
|---------|---------------------------|----------------------|
| 0002063 | 11in Orange Washout Brush | link |



1234335

| PART # | DESCRIPTION | LINK |
|---------|--------------------------|----------------------|
| 1234335 | 5ft Washout Brush Handle | link |



0002060

| PART # | DESCRIPTION | LINK |
|---------|--------------------------|----------------------|
| 0002060 | Chute Scraper w/o Handle | link |



0002064

| PART # | DESCRIPTION | LINK |
|---------|----------------------|----------------------|
| 0002064 | Chute Scraper Handle | link |



1327549

| PART # | DESCRIPTION | LINK |
|---------|-----------------------|----------------------|
| 1327549 | Main Chute Rock Guard | link |



1182512

| PART # | DESCRIPTION | LINK |
|---------|-------------------|----------------------|
| 1182512 | Shute Shutter Kit | link |

| | | |
|---------|----------------------------|----------------------|
| 1102920 | Shute Shutter Autolock Kit | link |
|---------|----------------------------|----------------------|

SCHWING CHUTES



60306863

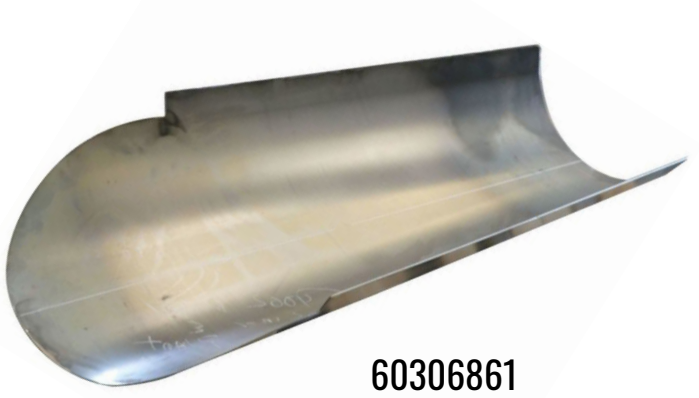

60306861

| PART # | DESCRIPTION | LINK |
|----------|-------------|----------------------|
| 60306863 | Main Chute | link |

| PART # | DESCRIPTION | LINK |
|----------|------------------|----------------------|
| 60306861 | Main Chute Liner | link |



98338569

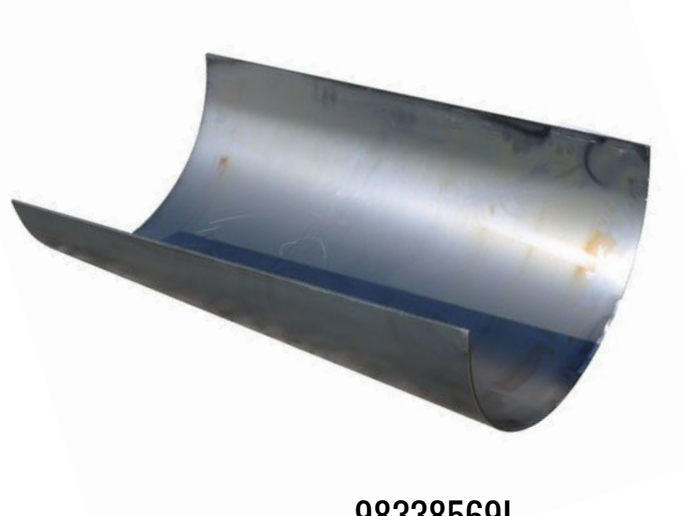

98338569L

| PART # | DESCRIPTION | LINK |
|----------|-----------------|----------------------|
| 98338569 | Fold Over Chute | link |

| PART # | DESCRIPTION | LINK |
|-----------|-----------------------|----------------------|
| 98338569L | Fold Over Chute Liner | link |



30389439

| PART # | DESCRIPTION | LINK |
|----------|------------------------|----------------------|
| 30389439 | Paving Folf Over Chute | link |

SCHWING CHUTES



98384255

| PART # | DESCRIPTION | LINK |
|----------|--------------------------|----------------------|
| 98384255 | 48in Al. Extension Chute | link |



98384255L

| PART # | DESCRIPTION | LINK |
|-----------|--------------------|----------------------|
| 98384255L | Liner for 98384255 | link |



60306114

| PART # | DESCRIPTION | LINK |
|----------|-------------------------|----------------------|
| 60306114 | 4ft St. Extension Chute | link |



60306114L

| PART # | DESCRIPTION | LINK |
|-----------|--------------------|----------------------|
| 60306114L | Liner for 60306114 | link |



30389440

| PART # | DESCRIPTION | LINK |
|----------|-----------------------|----------------------|
| 30389440 | Steel Extension Chute | link |



98389320

| PART # | DESCRIPTION | LINK |
|----------|---------------------|----------------------|
| 98389320 | Al. Extension Chute | link |

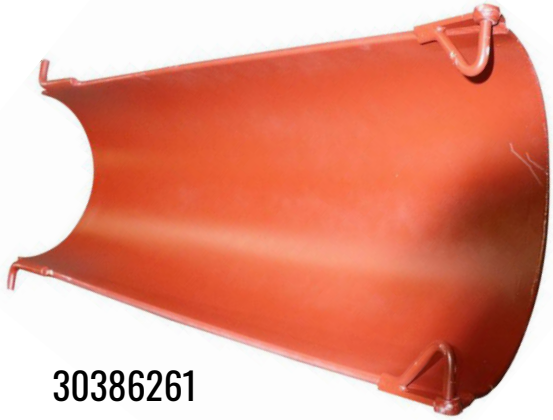

30386261

| PART # | DESCRIPTION | LINK |
|----------|-------------------------|----------------------|
| 30386261 | Tapered Extension Chute | link |



30386564

| PART # | DESCRIPTION | LINK |
|----------|--------------------|----------------------|
| 30386564 | Chute Rock Blocker | link |

| PART # | DESCRIPTION | LINK |
|----------|---------------------|----------------------|
| 30389988 | Al. Extension Chute | link |



30389352

| PART # | DESCRIPTION | LINK |
|----------|-------------------|----------------------|
| 30389352 | Shute Shutter Kit | link |



30389960

| PART # | DESCRIPTION | LINK |
|----------|--------------------|----------------------|
| 30389960 | Chute Finger Saver | link |

CHUTE ACCESSORIES



67215

| PART # | DESCRIPTION | LINK |
|--------|---------------------|----------------------|
| 67215 | Chute Lift Cylinder | link |



67012

| PART # | DESCRIPTION | LINK |
|--------|--------------------------|----------------------|
| 67012 | Fold Over Chute Cylinder | link |



67014

| PART # | DESCRIPTION | LINK |
|--------|----------------------|----------------------|
| 67014 | Cylinder Conn. Plate | link |



67016

| PART # | DESCRIPTION | LINK |
|--------|---------------------|----------------------|
| 67016 | Fold Over Crank Arm | link |



A128491

| PART # | DESCRIPTION | LINK |
|---------|---------------------|----------------------|
| A128491 | Chain and Hook Ass. | link |
| A1282C3 | Plated Snap Hook | link |



A1245B1

| PART # | DESCRIPTION | LINK |
|---------|-------------------------|----------------------|
| A1245B1 | Chute Hanger Cable Link | link |



A123FC8

| PART # | DESCRIPTION | LINK |
|---------|-----------------------|----------------------|
| A123FC8 | Finger Saver Assembly | link |



A12458F



A12726C

| PART # | DESCRIPTION | LINK |
|---------|---------------------|----------------------|
| A12458F | Aluminum Chute Clip | link |
| A12726C | Plastic Chute Clip | link |



A12A9F5

| PART # | DESCRIPTION | LINK |
|---------|--------------------|----------------------|
| A12A9F5 | 10in Hold Down Kit | link |



A128616

| PART # | DESCRIPTION | LINK |
|---------|--------------------|----------------------|
| A128616 | 15in Hold Down Kit | link |



A126D6F

| PART # | DESCRIPTION | LINK |
|---------|-------------------------|----------------------|
| A126D6F | 10in Rubber Chute Strap | link |



A125D26

| PART # | DESCRIPTION | LINK |
|---------|-------------------------|----------------------|
| A125D26 | 15in Rubber Chute Strap | link |

CHUTE ACCESSORIES



A128300

| PART # | DESCRIPTION | LINK |
|---------|---------------------|----------------------|
| A128300 | Chute Rack Assembly | link |



A127ABC

| PART # | DESCRIPTION | LINK |
|---------|---------------------|----------------------|
| A127ABC | Chute Mount Bracket | link |



A1284AD

| PART # | DESCRIPTION | LINK |
|---------|---------------------|----------------------|
| A1284AD | Chute Mount Bracket | link |

| PART # | DESCRIPTION | LINK |
|---------|-------------------------|----------------------|
| A129438 | Extension Chute Carrier | link |



A124C8C

| PART # | DESCRIPTION | LINK |
|---------|---------------------|----------------------|
| A124C8C | Scraper Handle ONLY | link |



A127606

| PART # | DESCRIPTION | LINK |
|---------|------------------------|----------------------|
| A127606 | Chute Scraper + Handle | link |



A124C8B

| PART # | DESCRIPTION | LINK |
|---------|--------------------|----------------------|
| A124C8B | Chute Scraper ONLY | link |



A12826E

| PART # | DESCRIPTION | LINK |
|---------|-----------------------|----------------------|
| A125270 | Vibrator - SandBuster | link |

| PART # | DESCRIPTION | LINK |
|---------|-----------------|----------------------|
| A1272EC | Piston Vibrator | link |

| PART # | DESCRIPTION | LINK |
|---------|---------------------|----------------------|
| A12826E | Main Chute Vibrator | link |



A12990A



A129903



A129902

| PART # | DESCRIPTION | LINK |
|---------|--|----------------------|
| A129903 | Keep Hands Away from Chute Pivot Points Decal | link |
| A12990A | Always Secure Foldover Chute with Safety Chain Decal | link |
| A129902 | Do Not Exceed Three Extension Chutes. Serious Injury Can Occur Decal | link |

| PART # | DESCRIPTION | LINK |
|--------|-------------------------|----------------------|
| 43150 | Post 2013 Charge Hopper | link |

| PART # | DESCRIPTION | LINK |
|--------|-------------------------|----------------------|
| 43018 | Charge Hopper Light Bar | link |



| PART # | DESCRIPTION | LINK |
|--------|---------------------------|----------------------|
| 43101 | Upper Charge Hopper Liner | link |

| PART # | DESCRIPTION | LINK |
|--------|---------------------|----------------------|
| 48010 | Air Hopper Cylinder | link |



| PART # | DESCRIPTION | LINK |
|--------|---------------------------|----------------------|
| 43102 | Lower Charge Hopper Liner | link |

CONTINENTAL HOPPERS

90540800



| PART # | DESCRIPTION | LINK |
|----------|-------------------------|----------------------|
| 90540800 | Low Profile Std. Hopper | link |

90540900



| PART # | DESCRIPTION | LINK |
|----------|---------------|----------------------|
| 90540900 | Charge Hopper | link |

90541100



| PART # | DESCRIPTION | LINK |
|----------|-----------------------|----------------------|
| 90541100 | Express Charge Hopper | link |

90540904



| PART # | DESCRIPTION | LINK |
|----------|---------------------------|----------------------|
| 90540904 | Charge Hopper Lower Liner | link |

| PART # | DESCRIPTION | LINK |
|----------|---------------------|----------------------|
| 90540901 | Charge Hopper Liner | link |



90540906

| PART # | DESCRIPTION | LINK |
|----------|--------------------|----------------------|
| 90540906 | 2in Hopper Cushion | link |



80151692

| PART # | DESCRIPTION | LINK |
|----------|---------------------|----------------------|
| 80151692 | Air Hopper Cylinder | link |



10101375

| PART # | DESCRIPTION | LINK |
|----------|------------------------|----------------------|
| 10101375 | 100ft Air Brake Tubing | link |



90150103

| PART # | DESCRIPTION | LINK |
|----------|----------------------|----------------------|
| 90150102 | Air Cylinder Bracket | link |

| PART # | DESCRIPTION | LINK |
|----------|---------------|----------------------|
| 90150103 | Swivel Clevis | link |



216261



215277

| PART # | DESCRIPTION | LINK |
|--------|-------------------|----------------------|
| 216261 | Drop Paver Hopper | link |

| PART # | DESCRIPTION | LINK |
|--------|--------------------|----------------------|
| 215277 | Std. Charge Hopper | link |



215289

| PART # | DESCRIPTION | LINK |
|--------|--------------------|----------------------|
| 215289 | Low Profile Hopper | link |



215346

| PART # | DESCRIPTION | LINK |
|--------|---------------|----------------------|
| 215346 | Charge Hopper | link |

| PART # | DESCRIPTION | LINK |
|--------|------------------|----------------------|
| 215074 | Hopper Pivot Lug | link |

| PART # | DESCRIPTION | LINK |
|--------|---------------|----------------------|
| 215178 | Charge Hopper | link |



215178

| PART # | DESCRIPTION | LINK |
|--------|-----------------------|----------------------|
| 215178 | Cylinder Mounting Eye | link |



215428

| PART # | DESCRIPTION | LINK |
|--------|-------------------|----------------------|
| 215428 | Hopper Body Liner | link |



730400

| PART # | DESCRIPTION | LINK |
|--------|-----------------------|----------------------|
| 730400 | Urethans Hopper Liner | link |

| PART # | DESCRIPTION | LINK |
|--------|----------------|----------------------|
| 215080 | Light Bar Tube | link |

| PART # | DESCRIPTION | LINK |
|--------|------------------|----------------------|
| 215077 | Hopper Light Bar | link |



750002

| PART # | DESCRIPTION | LINK |
|--------|---------------------|----------------------|
| 750002 | Air Hopper Cylinder | link |

| PART # | DESCRIPTION | LINK |
|--------|-------------|------|
|--------|-------------|------|

H34004 B3/F5 Standard Hopper [link](#)

| PART # | DESCRIPTION | LINK |
|--------|-------------|------|
|--------|-------------|------|

MD39753 Loading Hopper [link](#)

| PART # | DESCRIPTION | LINK |
|--------|-------------|------|
|--------|-------------|------|

MD40195 Charge Hopper w/ Liner [link](#)

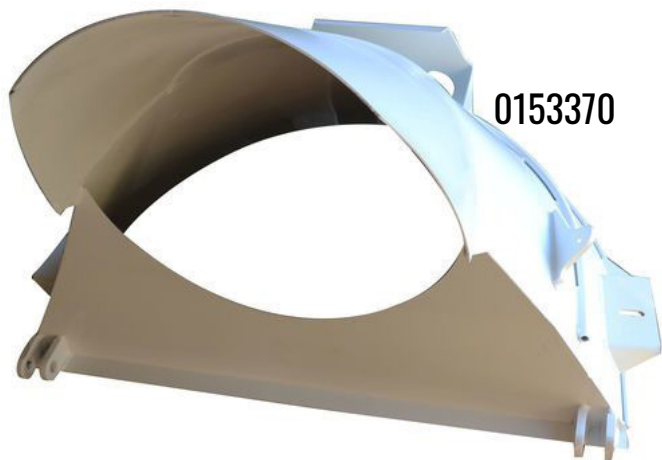

| PART # | DESCRIPTION | LINK |
|--------|-------------|------|
|--------|-------------|------|

0153370 Std./Flip Charge Hopper [link](#)



| PART # | DESCRIPTION | LINK |
|--------|-------------|------|
|--------|-------------|------|

0155130 Std./Flip Charge Hopper [link](#)

| PART # | DESCRIPTION | LINK |
|--------|-------------|------|
|--------|-------------|------|

18755 Hopper Cylinder [link](#)

| PART # | DESCRIPTION | LINK |
|--------|-------------|------|
|--------|-------------|------|

MD39666 Standard Air Hopper [link](#)



| PART # | DESCRIPTION | LINK |
|--------|-------------|------|
|--------|-------------|------|

0153605 Low Profile Hopper [link](#)



| PART # | DESCRIPTION | LINK |
|--------|-------------|------|
|--------|-------------|------|

0155140 Hopper Body Liner [link](#)



1105498

| PART # | DESCRIPTION | LINK |
|---------|-----------------|----------------------|
| 1105498 | 46in Paver Drop | link |



30386620

| PART # | DESCRIPTION | LINK |
|----------|------------------------|----------------------|
| 30386620 | Charge Tilt Air Hopper | link |

| PART # | DESCRIPTION | LINK |
|------------|-------------------------|----------------------|
| 60306041LL | Charge Hopper Lip Liner | link |

| PART # | DESCRIPTION | LINK |
|------------|-------------------------|----------------------|
| 60306041BL | Std./Flip Charge Hopper | link |

60306041



| PART # | DESCRIPTION | LINK |
|----------|-------------|----------------------|
| 60306041 | Hopper | link |

**PAGE
INTENTIONALLY
LEFT BLANK**

BECK AIR CONTROL VALVES & ACCESSORIES



36333

| PART # | DESCRIPTION | LINK |
|--------|-------------------------------|----------------------|
| 36333 | Chute Lock Air Valve Assembly | link |

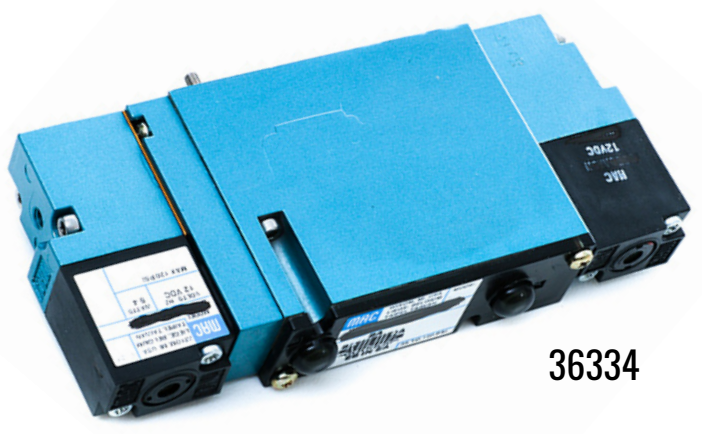

36334

| PART # | DESCRIPTION | LINK |
|--------|----------------------------------|----------------------|
| 36334 | Elec. Over Air Hopper Lift Valve | link |



36335

| PART # | DESCRIPTION | LINK |
|--------|---------------------|----------------------|
| 36335 | Auxiliary Air Valve | link |

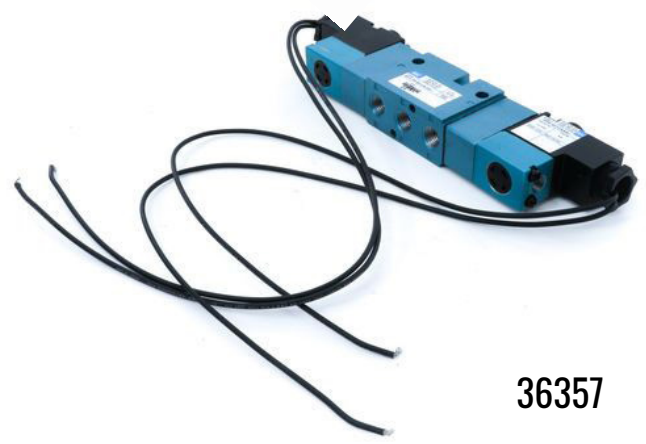

36357

| PART # | DESCRIPTION | LINK |
|--------|----------------|----------------------|
| 36357 | Axle Air Valve | link |



48030F

| PART # | DESCRIPTION | LINK |
|--------|----------------------------------|----------------------|
| 48030F | Elec. Over Air Hopper Lift Valve | link |



48030C

| PART # | DESCRIPTION | LINK |
|--------|---|----------------------|
| 48030C | Chute Lock Electric Over Air Valve Assembly | link |



75000



70118

| PART # | DESCRIPTION | LINK |
|--------|-------------------------------|----------------------|
| 75000 | .25in 0-125 PSI Air Regulator | link |

| PART # | DESCRIPTION | LINK |
|--------|---------------------------|----------------------|
| 70118 | .25in 0-100 PSI Air Gauge | link |



75600



75610

| PART # | DESCRIPTION | LINK |
|--------|------------------------------|----------------------|
| 75600 | Coalescing Filter Metal Bowl | link |

| PART # | DESCRIPTION | LINK |
|--------|----------------------|----------------------|
| 75610 | Metal Bowl for 75600 | link |



75615



48010

| PART # | DESCRIPTION | LINK |
|--------|---------------------------|----------------------|
| 75615 | Coalescing Filter Element | link |

| PART # | DESCRIPTION | LINK |
|--------|---------------------------------|----------------------|
| 48010 | 2.5in x 8in Air Hopper Cylinder | link |

BECK AIR CONTROL VALVES & ACCESSORIES

47510



| PART # | DESCRIPTION | LINK |
|--------|--------------------------|----------------------|
| 47510 | Service Chamber Assembly | link |

47070



| PART # | DESCRIPTION | LINK |
|--------|-------------------------|----------------------|
| 47070 | Type 16 Service Chamber | link |

47008

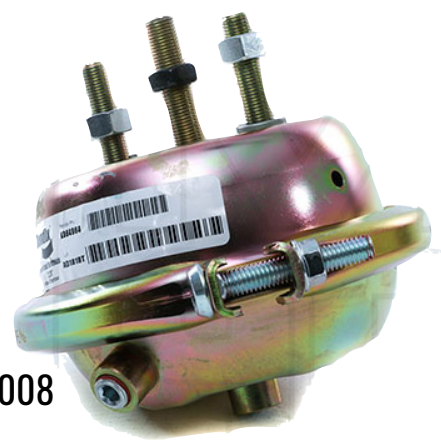

| PART # | DESCRIPTION | LINK |
|--------|--------------------------|----------------------|
| 47008 | Chute Lock Brake Chamber | link |

47012



| PART # | DESCRIPTION | LINK |
|--------|-------------------------|----------------------|
| 47012 | Brake Chamber Diaphragm | link |

70112



| PART # | DESCRIPTION | LINK |
|--------|-----------------|----------------------|
| 70112 | 3-Way Air Valve | link |

70215



| PART # | DESCRIPTION | LINK |
|--------|--------------------------------|----------------------|
| 70215 | Air Pressure Valve Block Assy. | link |



78000



78100

| PART # | DESCRIPTION | LINK |
|--------|-------------|------|
|--------|-------------|------|

| | | |
|-------|-------------------------|----------------------|
| 78000 | 55 PSI Air Safety Valve | link |
|-------|-------------------------|----------------------|

| PART # | DESCRIPTION | LINK |
|--------|-------------|------|
|--------|-------------|------|

| | | |
|-------|-------------------------------|----------------------|
| 78100 | 1/2in Air Safety Relief Valve | link |
|-------|-------------------------------|----------------------|

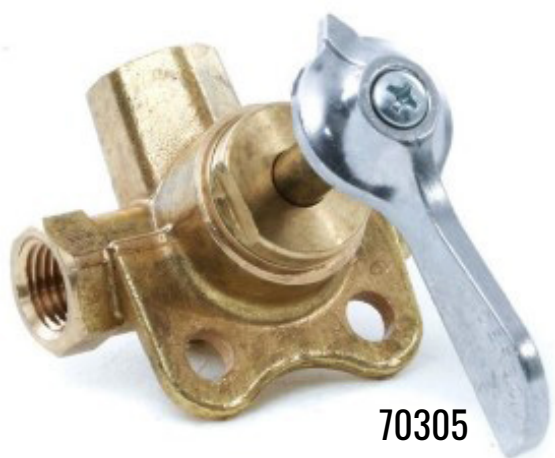

70305

| PART # | DESCRIPTION | LINK |
|--------|-------------|------|
|--------|-------------|------|

| | | |
|-------|--------------------------------|----------------------|
| 70305 | Three-Way Water Tank Air Valve | link |
|-------|--------------------------------|----------------------|

CONTINENTAL CONTROL VALVES & ACCESSORIES

80105734



80105735



| PART # | DESCRIPTION | LINK | PART # | DESCRIPTION | LINK |
|----------|-------------------------------------|----------------------|----------|---|----------------------|
| 80105734 | Electric Over Air Hopper Lift Valve | link | 80105735 | Chute Lock Electric Over Air Valve Assembly | link |

80100782



90100140



| PART # | DESCRIPTION | LINK | PART # | DESCRIPTION | LINK |
|----------|--|----------------------|----------|----------------------|----------------------|
| 80100782 | Hand Operated Charge Hopper Air Lift Valve | link | 90100140 | Air Chute Lock Valve | link |

90100050



10105734



| PART # | DESCRIPTION | LINK | PART # | DESCRIPTION | LINK |
|----------|---|----------------------|----------|--------------------------------|----------------------|
| 90100050 | Electric Over Air Valve for Hopper and Chute Lock | link | 10105734 | Air Pressure Valve Block Assy. | link |

90570019

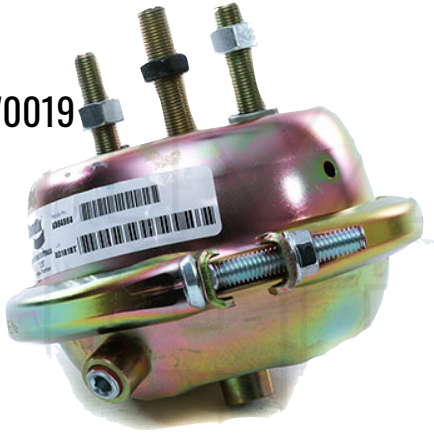

90570019D



| PART # | DESCRIPTION | LINK | PART # | DESCRIPTION | LINK |
|--------|-------------|------|--------|-------------|------|
|--------|-------------|------|--------|-------------|------|

90570019 Chute Lock Brake Chamber [link](#)

90570019D Type 16 Air Brake Chamber Diaphragm [link](#)



80151692



90150103

| PART # | DESCRIPTION | LINK | PART # | DESCRIPTION | LINK |
|--------|-------------|------|--------|-------------|------|
|--------|-------------|------|--------|-------------|------|

80151692 2.5in x 8in Air Hopper Cylinder [link](#)

90150103 Air Hopper Cylinder Swivel Clevis for 80151692 [link](#)

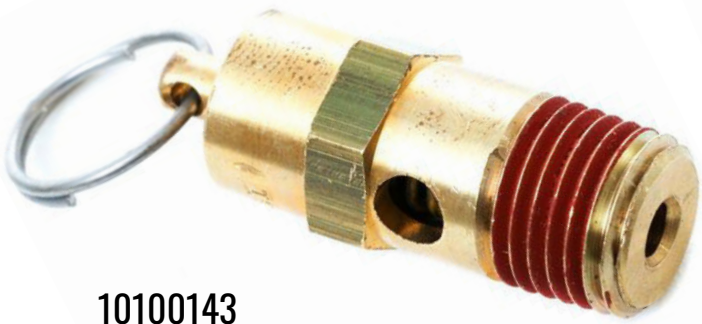

10100143

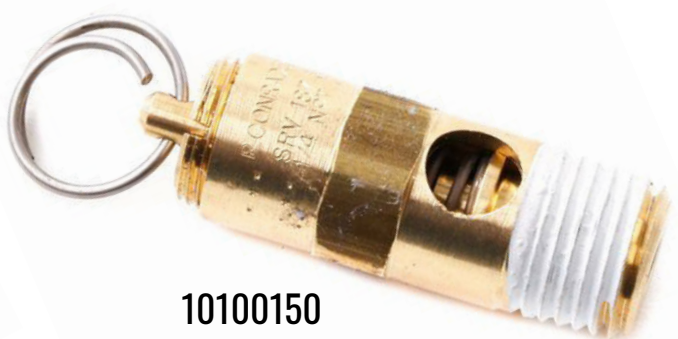

10100150

| PART # | DESCRIPTION | LINK | PART # | DESCRIPTION | LINK |
|--------|-------------|------|--------|-------------|------|
|--------|-------------|------|--------|-------------|------|

10100143 75 PSI Air Safety Valve [link](#)

10100150 55 PSI Air Safety Valve [link](#)

CONTINENTAL CONTROL VALVES & ACCESSORIES



80100466

| PART # | DESCRIPTION | LINK |
|----------|--|----------------------|
| 80100466 | 1/2in Bronze Air Safety Relief Valve - 60PSI | link |



10109080

| PART # | DESCRIPTION | LINK |
|----------|-------------------------------|----------------------|
| 10109080 | Air Pressure Protection Valve | link |



10100163

| PART # | DESCRIPTION | LINK |
|----------|--------------------------------|----------------------|
| 10100163 | .25in Adjustable Air Regulator | link |



10100167

| PART # | DESCRIPTION | LINK |
|----------|---------------------|----------------------|
| 10100167 | Watts Air Regulator | link |



10100835

| PART # | DESCRIPTION | LINK |
|----------|--------------------------------|----------------------|
| 10100835 | 50psi Non-Adjustable Regulator | link |



10100146

| PART # | DESCRIPTION | LINK |
|----------|--|----------------------|
| 10100146 | 1/4in Bottom Mount 2in Air Gauge 0-100 PSI | link |

10100147



10100945

| PART # | DESCRIPTION | LINK | PART # | DESCRIPTION | LINK |
|----------|---|----------------------|----------|--|----------------------|
| 10100147 | .25in Center Back Mount 2in Air Gauge 0-100 PSI | link | 10100945 | 2in Face 0-160 PSI 1/4in Center Back Mount | link |

10100152



10100154



| PART # | DESCRIPTION | LINK | PART # | DESCRIPTION | LINK |
|----------|-----------------|----------------------|----------|--------------------------------|----------------------|
| 10100152 | 3-Way Air Valve | link | 10100154 | Three-Way Water Tank Air Valve | link |

CON-TECH CONTROL VALVES & ACCESSORIES

760030



760079



| PART # | DESCRIPTION | LINK |
|--------|-------------|------|
|--------|-------------|------|

| | | |
|--------|--|----------------------|
| 760030 | 1/2in Bronze Air Safety Relief Valve - 60PSI | link |
|--------|--|----------------------|

| PART # | DESCRIPTION | LINK |
|--------|-------------|------|
|--------|-------------|------|

| | | |
|--------|---------------------------|----------------------|
| 760079 | 3/4in Quick Release Valve | link |
|--------|---------------------------|----------------------|

760020



760023



| PART # | DESCRIPTION | LINK |
|--------|-------------|------|
|--------|-------------|------|

| | | |
|--------|-----------------------------------|----------------------|
| 760020 | Adjustable Air Regulator 0-60 PSI | link |
|--------|-----------------------------------|----------------------|

| PART # | DESCRIPTION | LINK |
|--------|-------------|------|
|--------|-------------|------|

| | | |
|--------|---|----------------------|
| 760023 | 1/4in NPT Air Pressure Protection Valve | link |
|--------|---|----------------------|

760052



760053

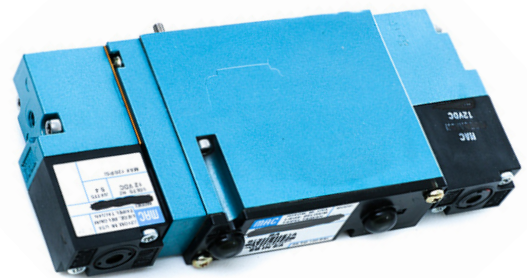

| PART # | DESCRIPTION | LINK |
|--------|-------------|------|
|--------|-------------|------|

| | | |
|--------|-------------------------------|----------------------|
| 760052 | Chute Lock Air Valve Assembly | link |
|--------|-------------------------------|----------------------|

| PART # | DESCRIPTION | LINK |
|--------|-------------|------|
|--------|-------------|------|

| | | |
|--------|-------------------------------------|----------------------|
| 760053 | Electric over Air Hopper Lift Valve | link |
|--------|-------------------------------------|----------------------|

760054



760055

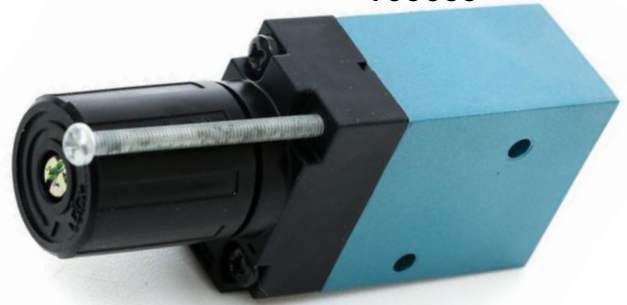

| PART # | DESCRIPTION | LINK | PART # | DESCRIPTION | LINK |
|--------|--------------------------|----------------------|--------|--------------------|----------------------|
| 760054 | Auxiliary Axle Air Valve | link | 760055 | Manifold Regulator | link |



760056

| PART # | DESCRIPTION | LINK |
|--------|-----------------------------|----------------------|
| 760056 | 160 PSI Air Regulator Gauge | link |

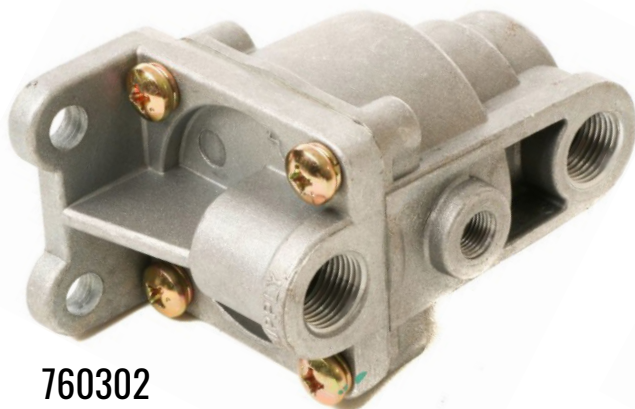

760302



760040

| PART # | DESCRIPTION | LINK | PART # | DESCRIPTION | LINK |
|--------|-----------------------------|----------------------|--------|-------------|----------------------|
| 760302 | Brake Limiting Valve - LQ-5 | link | 760040 | Drain Valve | link |

CON-TECH CONTROL VALVES & ACCESSORIES



785100

| PART # | DESCRIPTION | LINK |
|--------|--------------------------------|----------------------|
| 785100 | Wet Tank - Old Style Ears Down | link |



760032

| PART # | DESCRIPTION | LINK |
|--------|---|----------------------|
| 760032 | Chute Lock Electric Over Air Valve Assembly | link |



760033

| PART # | DESCRIPTION | LINK |
|--------|-------------------------------------|----------------------|
| 760033 | Electric Over Air Hopper Lift Valve | link |

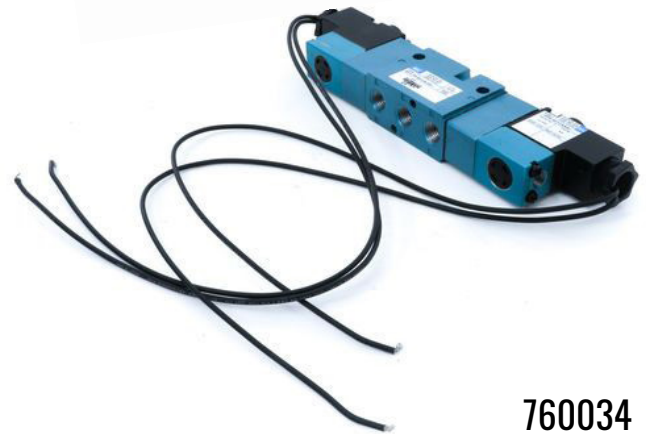

760034

| PART # | DESCRIPTION | LINK |
|--------|---|----------------------|
| 760034 | Axle Air Valve for Pusher Axle Override | link |



760035

| PART # | DESCRIPTION | LINK |
|--------|-------------------------------------|----------------------|
| 760035 | Air Regulator - 0-125 psi 1/4in NPT | link |

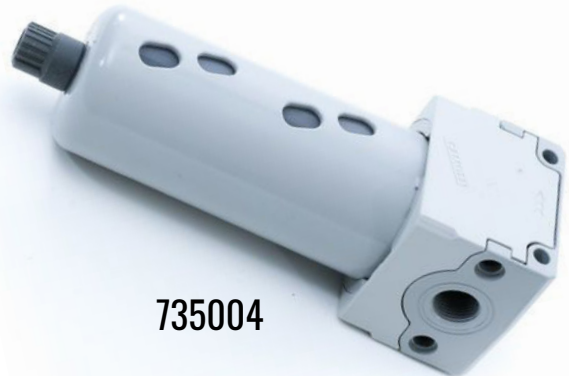

735004

| PART # | DESCRIPTION | LINK |
|--------|---------------------------------------|----------------------|
| 735004 | Coalescing Filter Assembly with Drain | link |



735014



735015

| PART # | DESCRIPTION | LINK |
|--------|---------------------------------|----------------------|
| 735014 | Poly Coalescing Air Filter Bowl | link |

| PART # | DESCRIPTION | LINK |
|--------|----------------------------|----------------------|
| 735015 | Coalescing Filter Assembly | link |



735016



735017

| PART # | DESCRIPTION | LINK |
|--------|--------------------------|----------------------|
| 735016 | Coalescing Aluminum Bowl | link |

| PART # | DESCRIPTION | LINK |
|--------|---------------------------------|----------------------|
| 735017 | Air Filter Element - Coalescing | link |

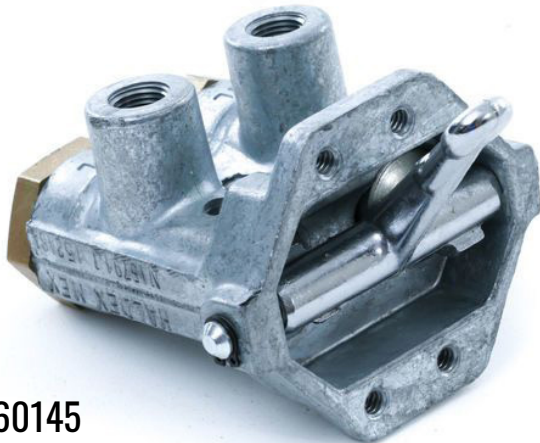

760145



750002

| PART # | DESCRIPTION | LINK |
|--------|--|----------------------|
| 760145 | Hand Operated Charge Hopper Air Lift Valve | link |

| PART # | DESCRIPTION | LINK |
|--------|---------------------------------|----------------------|
| 750002 | 2.5in x 8in Air Hopper Cylinder | link |

CON-TECH CONTROL VALVES & ACCESSORIES

730250



730251



| PART # | DESCRIPTION | LINK |
|--------|---------------------------|----------------------|
| 730250 | 1/2 Inch Black DOT Tubing | link |

| PART # | DESCRIPTION | LINK |
|--------|---------------------------|----------------------|
| 730251 | 5/8 Inch Black DOT Tubing | link |

760031

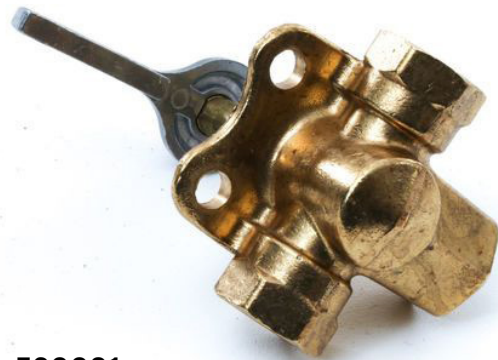

760021

| PART # | DESCRIPTION | LINK |
|--------|---------------------|----------------------|
| 760031 | Watts Air Regulator | link |

| PART # | DESCRIPTION | LINK |
|--------|-----------------|----------------------|
| 760021 | 3-Way Air Valve | link |

760022



| PART # | DESCRIPTION | LINK |
|--------|---|----------------------|
| 760022 | .25in Center Back Mount 2in Air Gauge 0-100 PSI | link |

| PART # | DESCRIPTION | LINK |
|--------|-----------------|----------------------|
| 18755 | Hopper Cylinder | link |

Includes:

5/8 x 1.75in Clevis Pin

1/8in x 2-9/19 XZ Hair Pin

1/4 NPT x 3/8 DOT Fitting with Orifice

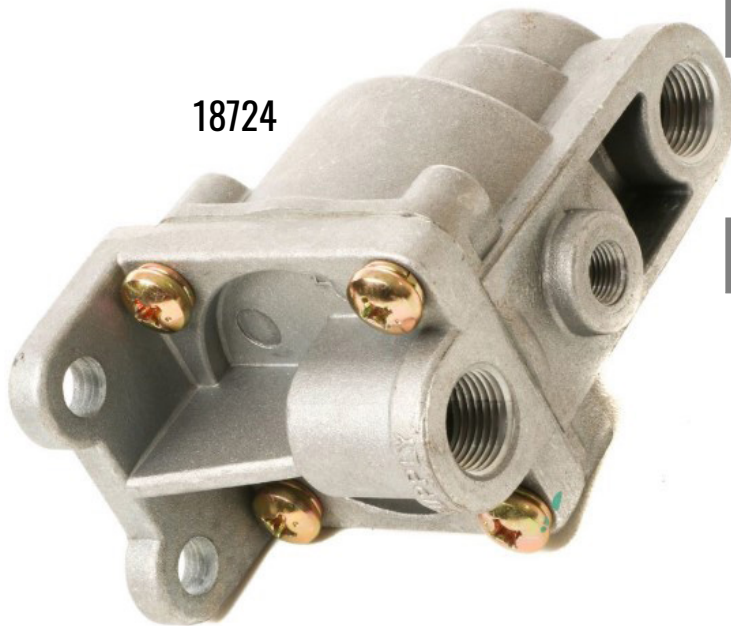

| PART # | DESCRIPTION | LINK |
|--------|---------------------------------|----------------------|
| 18754 | Charge Hopper Lift Valve for B3 | link |

| PART # | DESCRIPTION | LINK |
|--------|--------------------------------|----------------------|
| 18724 | Brake Proportional Valve - LQ5 | link |

KIMBLE CONTROL VALVES & ACCESSORIES

A130011100



C950010021



| PART # | DESCRIPTION | LINK |
|--------|-------------|------|
|--------|-------------|------|

A130011100 1/2in Bronze Air Safety Relief Valve - 60PSI [link](#)

| PART # | DESCRIPTION | LINK |
|--------|-------------|------|
|--------|-------------|------|

C950010021 Bottom Mount 2in Air Gauge 0-100 PSI [link](#)

A131010000



A110010100

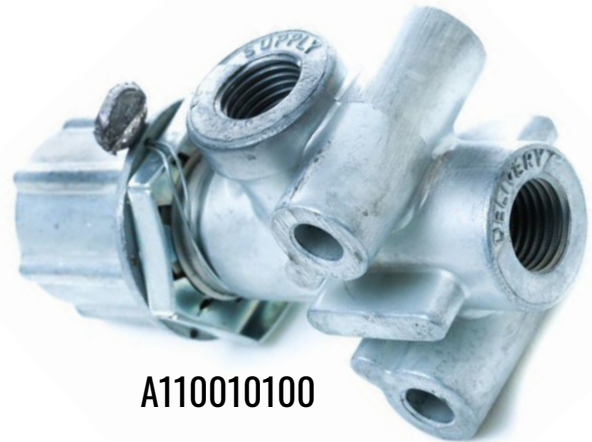

| PART # | DESCRIPTION | LINK |
|--------|-------------|------|
|--------|-------------|------|

A131010000 3-Way Air Valve [link](#)

| PART # | DESCRIPTION | LINK |
|--------|-------------|------|
|--------|-------------|------|

A110010100 Air Regulator [link](#)

| PART # | DESCRIPTION | LINK |
|--------|-------------|------|
|--------|-------------|------|

A121002500 4-Way Air Solenoid Valve - Hopper Cylinder - Chute Lock [link](#)

A121002500





0085288



0085283

| PART # | DESCRIPTION | LINK |
|--------|-------------|------|
|--------|-------------|------|

0085288 Electric Over Air Hopper Lift Valve [link](#)

| PART # | DESCRIPTION | LINK |
|--------|-------------|------|
|--------|-------------|------|

0085283 Air Hopper Monitor Switch [link](#)



0085284

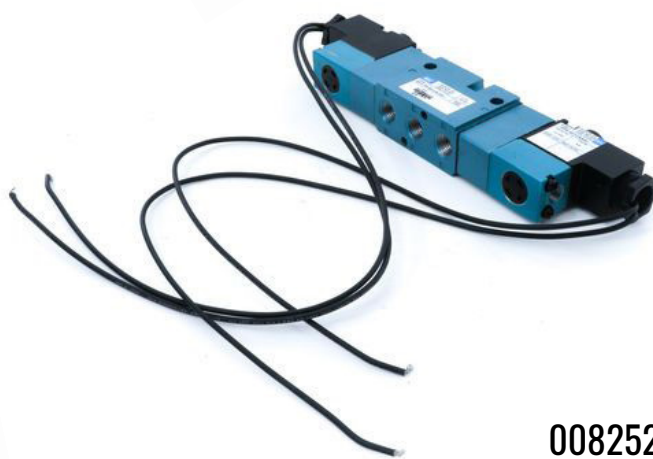

0082521

| PART # | DESCRIPTION | LINK |
|--------|-------------|------|
|--------|-------------|------|

0085284 Chute Lock Electric Over Air Valve Assembly [link](#)

| PART # | DESCRIPTION | LINK |
|--------|-------------|------|
|--------|-------------|------|

0082521 Axle Air Valve for Pusher Axle Override [link](#)



1358351

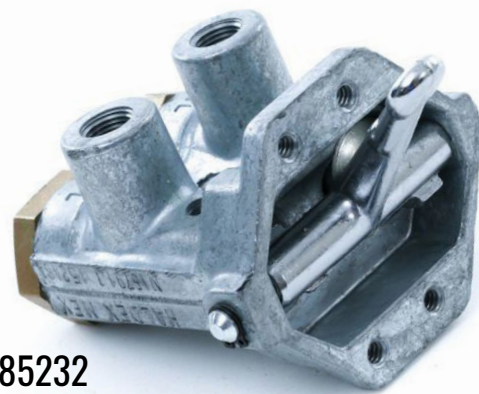

0085232

| PART # | DESCRIPTION | LINK |
|--------|-------------|------|
|--------|-------------|------|

1358351 Toggle Valve [link](#)

| PART # | DESCRIPTION | LINK |
|--------|-------------|------|
|--------|-------------|------|

0085232 Hand Operated Charge Hopper Air Lift Valve [link](#)

MCNEILUS CONTROL VALVES & ACCESSORIES

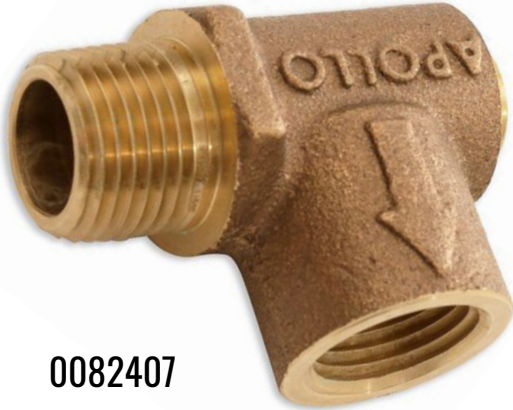

0082407



0087014

| PART # | DESCRIPTION | LINK |
|---------|--|----------------------|
| 0082407 | 1/2in Bronze Air Safety Relief Valve - 60PSI | link |

| PART # | DESCRIPTION | LINK |
|---------|---|----------------------|
| 0087014 | Single Air Pressure Gauge - 2 inch Face | link |



0110131



1113068

| PART # | DESCRIPTION | LINK |
|---------|---------------------------|----------------------|
| 0110131 | Pressure Gauge 1.5in Dial | link |

| PART # | DESCRIPTION | LINK |
|---------|--------------------------------|----------------------|
| 1113068 | Three-Way Water Tank Air Valve | link |



0082406



0150824

| PART # | DESCRIPTION | LINK |
|---------|---|----------------------|
| 0082406 | .25in Center Back Mount 2in Air Gauge 0-100 PSI | link |

| PART # | DESCRIPTION | LINK |
|---------|---|----------------------|
| 0150824 | Air Pressure 3-Way Valve Block Assembly | link |



1169462



0082403

| PART # | DESCRIPTION | LINK |
|---------|------------------------------|----------------------|
| 1169462 | Air Pressure Valve Cartridge | link |

| PART # | DESCRIPTION | LINK |
|---------|--------------------------|----------------------|
| 0082403 | Adjustable Air Regulator | link |

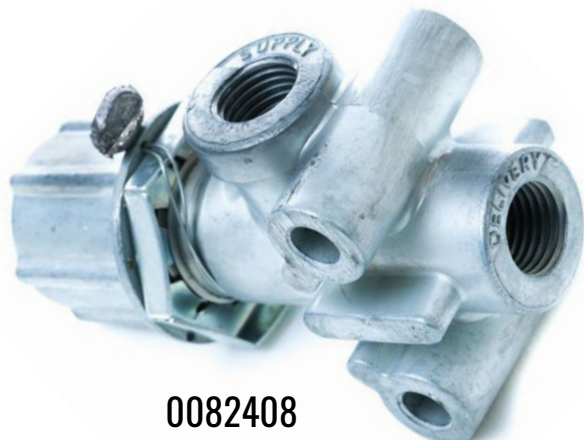

0082408



0087011

| PART # | DESCRIPTION | LINK |
|---------|---|----------------------|
| 0082408 | 1/4in NPT Air Pressure Protection Valve | link |

| PART # | DESCRIPTION | LINK |
|---------|-------------------------------------|----------------------|
| 0087011 | Air Regulator - 0-125 psi 1/4in NPT | link |



614111



1138149

| PART # | DESCRIPTION | LINK |
|--------|-------------------------|----------------------|
| 614111 | Quick Release Air Valve | link |

| PART # | DESCRIPTION | LINK |
|---------|-----------------------------|----------------------|
| 1138149 | 2 Place Manifold Valve Body | link |

MCNEILUS CONTROL VALVES & ACCESSORIES



1138152

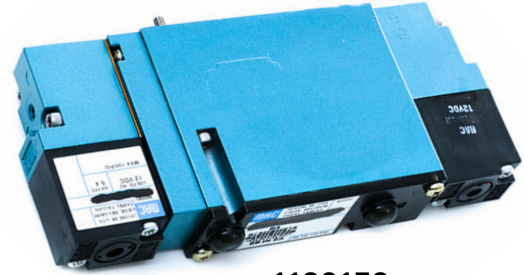

1138153

| PART # | DESCRIPTION | LINK | PART # | DESCRIPTION | LINK |
|---------|-------------------------------|----------------------|---------|-------------------------------------|----------------------|
| 1138152 | Chute Lock Air Valve Assembly | link | 1138153 | Electric over Air Hopper Lift Valve | link |



1138150



0620723

| PART # | DESCRIPTION | LINK | PART # | DESCRIPTION | LINK |
|---------|-----------------------------|----------------------|---------|-------------------------------|----------------------|
| 1138150 | 3 Place Manifold Valve Body | link | 0620723 | Air Regulator Gauge - 160 PSI | link |



1138154



1325247

| PART # | DESCRIPTION | LINK | PART # | DESCRIPTION | LINK |
|---------|--------------------------|----------------------|---------|--------------------------|----------------------|
| 1138154 | Auxiliary Axle Air Valve | link | 1325247 | Mounting Manifold Gasket | link |

MCNEILUS CONTROL VALVES & ACCESSORIES



0087036



0087015

| PART # | DESCRIPTION | LINK |
|--------|-------------|------|
|--------|-------------|------|

| | | |
|---------|-------------------------------------|----------------------|
| 0087036 | Pusher Axle Air Brake Exhaust Valve | link |
|---------|-------------------------------------|----------------------|

| PART # | DESCRIPTION | LINK |
|--------|-------------|------|
|--------|-------------|------|

| | | |
|---------|---------------------|----------------------|
| 0087015 | Quick Release Valve | link |
|---------|---------------------|----------------------|



0085860



0085290

| PART # | DESCRIPTION | LINK |
|--------|-------------|------|
|--------|-------------|------|

| | | |
|---------|-------------------|----------------------|
| 0085860 | Brake Relay Valve | link |
|---------|-------------------|----------------------|

| PART # | DESCRIPTION | LINK |
|--------|-------------|------|
|--------|-------------|------|

| | | |
|---------|-------------|----------------------|
| 0085290 | Relay Valve | link |
|---------|-------------|----------------------|

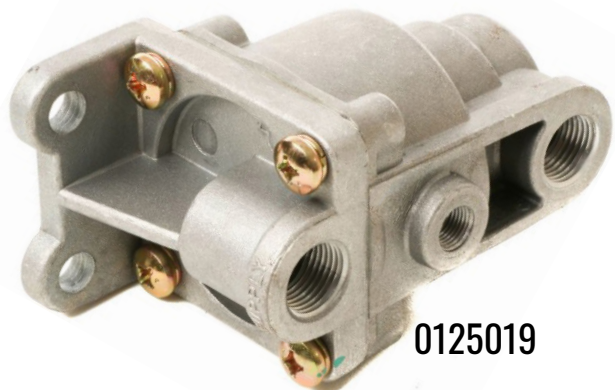

0125019

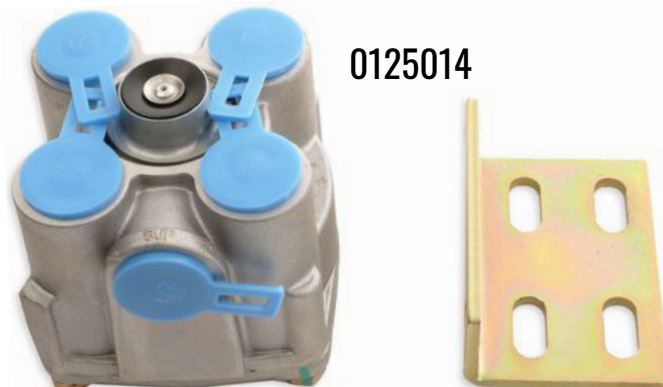

0125014

| PART # | DESCRIPTION | LINK |
|--------|-------------|------|
|--------|-------------|------|

| | | |
|---------|--------------------------------|----------------------|
| 0125019 | Brake Proportional Valve - LQ5 | link |
|---------|--------------------------------|----------------------|

| PART # | DESCRIPTION | LINK |
|--------|-------------|------|
|--------|-------------|------|

| | | |
|---------|-------------------|----------------------|
| 0125014 | Brake Relay Valve | link |
|---------|-------------------|----------------------|

MCNEILUS CONTROL VALVES & ACCESSORIES



1321745

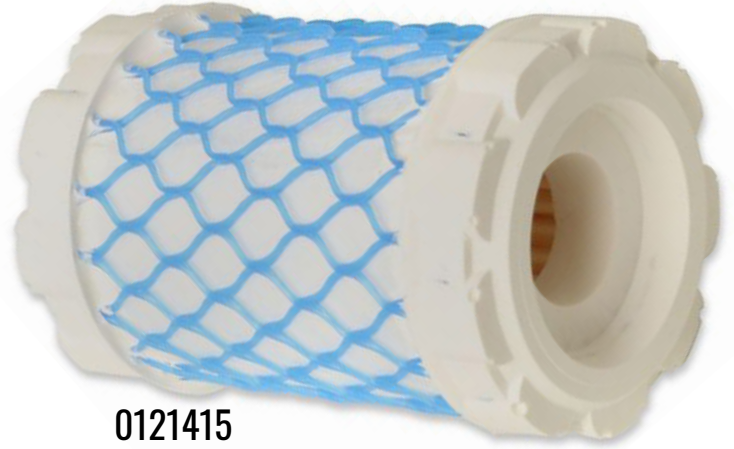

0121415

| PART # | DESCRIPTION | LINK |
|---------|----------------------------|----------------------|
| 1321745 | Coalescing Filter Assembly | link |

| PART # | DESCRIPTION | LINK |
|---------|-------------------------------|----------------------|
| 0121415 | Coalescing Air Filter Element | link |



0107616



1165683

| PART # | DESCRIPTION | LINK |
|---------|---------------------------------|----------------------|
| 0107616 | 2.5in x 8in Air Hopper Cylinder | link |

| PART # | DESCRIPTION | LINK |
|---------|---|----------------------|
| 1165683 | Air Hopper Cylinder Fitting for 107616 Cylinder | link |

| PART # | DESCRIPTION | LINK |
|---------|----------------------|----------------------|
| 0000004 | .25in Black Airline* | link |
| 0000006 | 3/8in Black Airline* | link |
| 0000007 | .5in Black Airline* | link |
| 0000009 | 5/8in Black Airline* | link |
| 1101218 | .75in Black Airline* | link |



* Specify Length. All Airline is Sold by the Foot.

SCHWING CONTROL VALVES & ACCESSORIES



30389272



30389288

| PART # | DESCRIPTION | LINK |
|--------|-------------|------|
|--------|-------------|------|

30389272 Three-Way Water Tank Air Valve [link](#)

| PART # | DESCRIPTION | LINK |
|--------|-------------|------|
|--------|-------------|------|

30389288 3 Way Valve Mounting Bracket [link](#)



98407873

| PART # | DESCRIPTION | LINK |
|--------|-------------|------|
|--------|-------------|------|

98407873 5-60 PSI 1/4in Pipe Regulator [link](#)



30314332

| PART # | DESCRIPTION | LINK |
|--------|-------------|------|
|--------|-------------|------|

30314332 Water Tank Air Pressure Gauge [link](#)



30389273

| PART # | DESCRIPTION | LINK |
|--------|-------------|------|
|--------|-------------|------|

30389273 Safety Valve [link](#)



30315297

| PART # | DESCRIPTION | LINK |
|--------|-------------|------|
|--------|-------------|------|

30315297 Air Relay Valve [link](#)

PAGE INTENTIONALLY LEFT BLANK

BECK REBUILT EXCHANGE PUMPS AND MOTORS

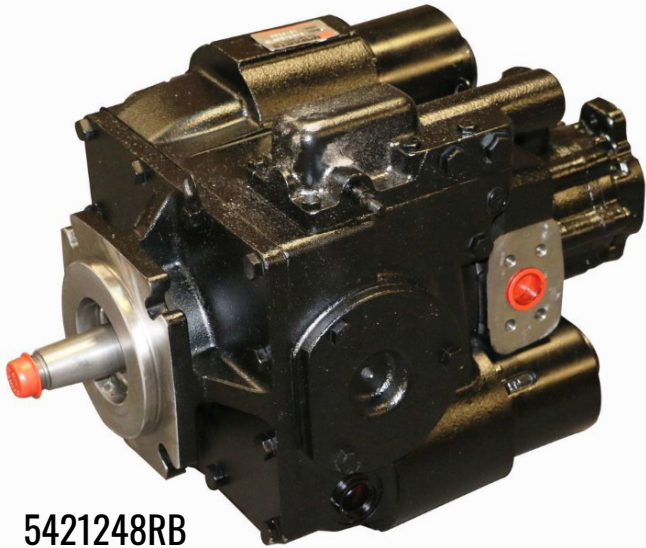

5421248RB

| PART # | DESCRIPTION | LINK |
|-----------|-------------------------------------|----------------------|
| 5421248RB | Rebuilt Eaton Pump Left Hand A-Pad | link |
| 5421247RB | Rebuilt Eaton Pump Right Hand A-Pad | link |



5423550

| PART # | DESCRIPTION | LINK |
|---------|---|----------------------|
| 5423550 | Rebuilt Eaton Pump Right Hand A-Pad 1.5in Shaft | link |
| 5423551 | Rebuilt Eaton Pump Left Hand A-Pad 1.5in Shaft | link |

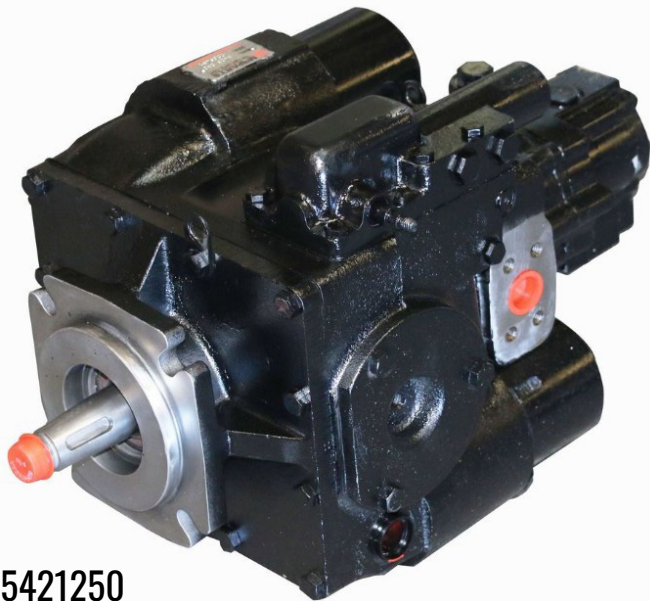

5421250

| PART # | DESCRIPTION | LINK |
|---------|-----------------------------------|----------------------|
| 5421250 | Rebuilt Eaton Pump Left Hand DECP | link |



5421552

| PART # | DESCRIPTION | LINK |
|---------|--|----------------------|
| 5421552 | Rebuilt Eaton Pump Dual Element Charge 1.5in Shaft | link |



5423554

| PART # | DESCRIPTION | LINK |
|---------|---|----------------------|
| 5423554 | Rebuilt Eaton Pump Left Hand Standard 1.5in Shaft | link |

CBMW HYDRAULIC REPLACEMENT PARTS

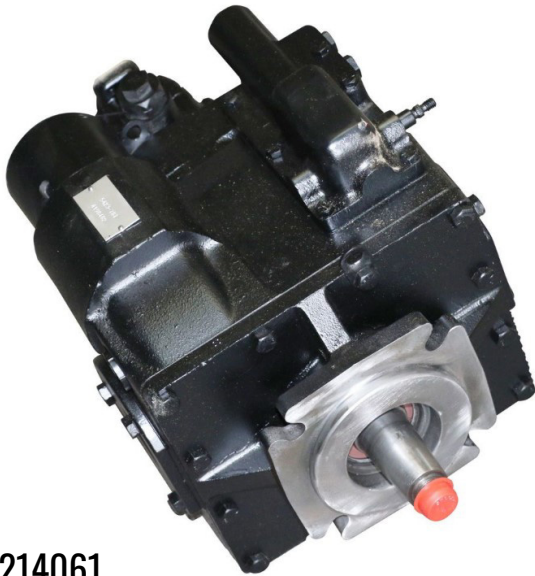

10214061

| PART # | DESCRIPTION | LINK |
|----------|--|----------------------|
| 10214061 | Hydraulic Pump - Right Hand with A-Pad Charge Pump | link |
| 10214062 | Hydraulic Pump - Left Hand with A-Pad Charge Pump | link |



10214063

| PART # | DESCRIPTION | LINK |
|----------|--|----------------------|
| 10214063 | Rebuilt Left Hand Hydrostatic Pump with RE Control | link |

CBMW HYDRAULIC REPLACEMENT PARTS



10214064

| PART # | DESCRIPTION | LINK |
|----------|---|----------------------|
| 10214064 | Rebuilt Right Hand Hydrostatic Pump with RE Control | link |



10230501

| PART # | DESCRIPTION | LINK |
|----------|---------------|----------------------|
| 10230501 | Control Valve | link |



10225029

| PART # | DESCRIPTION | LINK |
|----------|-----------------------------------|----------------------|
| 10225029 | Rebuilt 46 Series Hydraulic Motor | link |
| 10225030 | Rebuilt Hydraulic Motor | link |

CONTECH PUMPS AND MOTORS



745415

| PART # | DESCRIPTION | LINK |
|--------|--|----------------------|
| 745415 | NEW Right Hand A-Pad Hydrostatic Pump with RE Control (Electronic) | link |

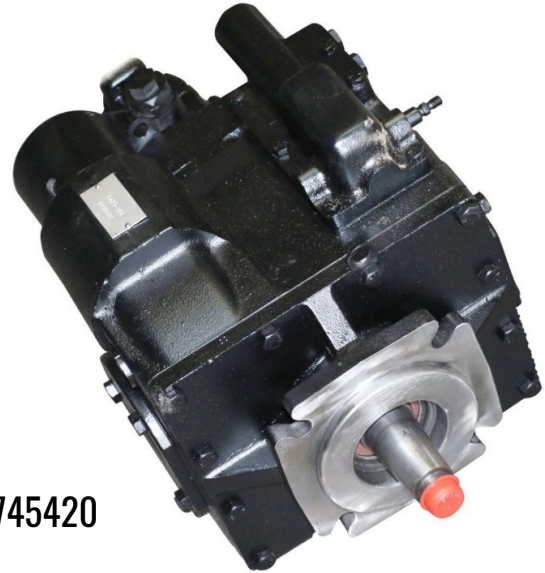

745420

| PART # | DESCRIPTION | LINK |
|--------|---|----------------------|
| 745420 | NEW Right Hand Manual A-Pad Pump (Manual) | link |

MCNEILUS PUMPS AND MOTORS



0003266

| PART # | DESCRIPTION | LINK |
|---------|---|----------------------|
| 0003266 | Reman Eaton Right Hand Standard 1.5in Shaft | link |



0003209

| PART # | DESCRIPTION | LINK |
|---------|--------------------------------------|----------------------|
| 0003209 | Reman Left Hand A-Pad Hydraulic Pump | link |



0003211

| PART # | DESCRIPTION | LINK |
|---------|--|----------------------|
| 0003211 | Rebuilt Counter Clockwise Hydrostatic Pump | link |



0003264

| PART # | DESCRIPTION | LINK |
|---------|------------------------------------|----------------------|
| 0003264 | Rebuilt Clockwise Hydrostatic Pump | link |



0003253

| PART # | DESCRIPTION | LINK |
|---------|------------------------------|----------------------|
| 0003253 | Hydraulic Motor without HPRV | link |



0003251

| PART # | DESCRIPTION | LINK |
|---------|---|----------------------|
| 0003251 | Reman Hydraulic Motor-21 Spline with HPRV Block | link |



61300

| PART # | DESCRIPTION | LINK |
|--------|-------------------------------------|----------------------|
| 61300 | .25in NPT Slump Gauge with Pointers | link |



61102

| PART # | DESCRIPTION | LINK |
|--------|--|----------------------|
| 61102 | 160 Degree Hydraulic Cooler Thermal Switch | link |



61103

| PART # | DESCRIPTION | LINK |
|--------|--|----------------------|
| 61103 | 180 Degree Hydraulic Cooler Upper Thermal Temperature Switch | link |



61110

| PART # | DESCRIPTION | LINK |
|--------|------------------------------------|----------------------|
| 61110 | Hydraulic Oil Cooler Fan and Motor | link |



61140

| PART # | DESCRIPTION | LINK |
|--------|---------------------------------------|----------------------|
| 61140 | Hydraulic Cooler Lower Thermal Switch | link |



61215

| PART # | DESCRIPTION | LINK |
|--------|------------------------------|----------------------|
| 61215 | Hydraulic Spin On Oil Filter | link |

BECK HYDRAULIC SYSTEM PARTS



63100

| PART # | DESCRIPTION | LINK |
|--------|------------------------|----------------------|
| 63100 | Hydraulic Motor Gasket | link |



60005

| PART # | DESCRIPTION | LINK |
|--------|-----------------------|----------------------|
| 60005 | .75in Oil Sight Gauge | link |



67010

| PART # | DESCRIPTION | LINK |
|--------|---|----------------------|
| 67010 | Mixer Double Acting Chute Lift Cylinder | link |



61210

| PART # | DESCRIPTION | LINK |
|--------|-----------------------|----------------------|
| 61210 | 0-30 PSI Vacuum Gauge | link |



64650

| PART # | DESCRIPTION | LINK |
|--------|---|----------------------|
| 64650 | Hydraulic Chute Block Assembly Manifold - Single Acting | link |

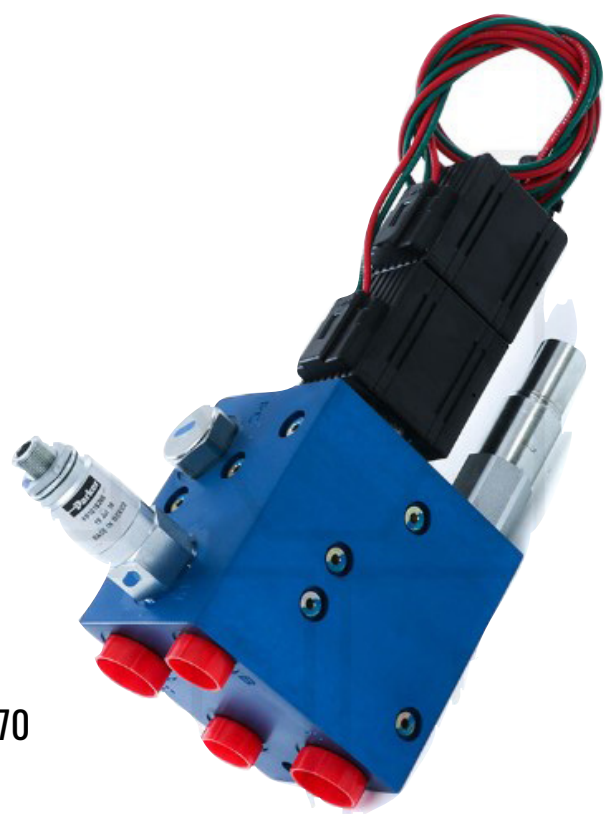

64770

| PART # | DESCRIPTION | LINK |
|--------|----------------------------|----------------------|
| 64770 | Chute Block Valve Assembly | link |

| PART # | DESCRIPTION | LINK |
|--------|---------------------------|----------------------|
| 64772 | Chute Block Solenoid Coil | link |



62025

| PART # | DESCRIPTION | LINK |
|--------|---------------------|----------------------|
| 62025 | 12 Volt DC Solenoid | link |



62000

| PART # | DESCRIPTION | LINK |
|--------|--------------------------------|----------------------|
| 62000 | Chute Power Unit - Push Button | link |

BECK HYDRAULIC SYSTEM PARTS



62725

| PART # | DESCRIPTION | LINK |
|--------|-----------------------|----------------------|
| 62725 | Start Switch Solenoid | link |



66000RB

| PART # | DESCRIPTION | LINK |
|---------|------------------------------|----------------------|
| 66000RB | Rebuilt Exchange Gearbox | link |
| 66000 | NEW Mixer Drum Drive Gearbox | link |

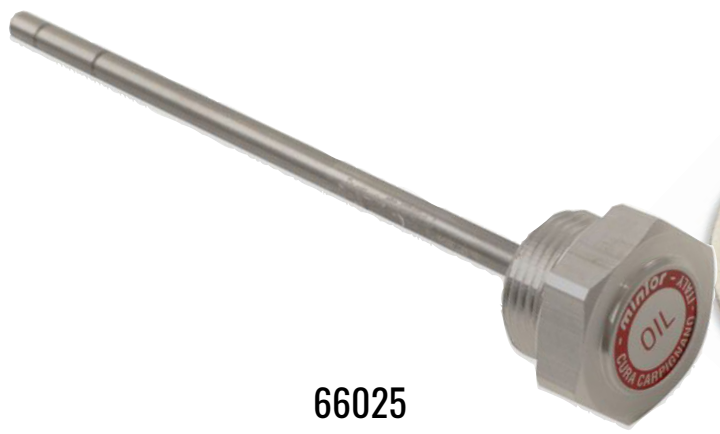

66025

| PART # | DESCRIPTION | LINK |
|--------|----------------------------|----------------------|
| 66025 | Drum Drive Vented Dipstick | link |



66030

| PART # | DESCRIPTION | LINK |
|--------|--------------------------------------|----------------------|
| 66030 | Mixer Drum Drive Gearbox Sight Gauge | link |



66040

| PART # | DESCRIPTION | LINK |
|--------|----------------------|----------------------|
| 66040 | Gearbox Main Bearing | link |



66045

| PART # | DESCRIPTION | LINK |
|--------|-------------|----------------------|
| 66045 | Shaft Seal | link |

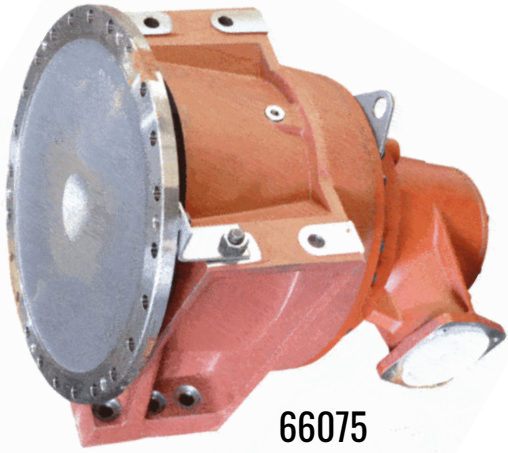

66075

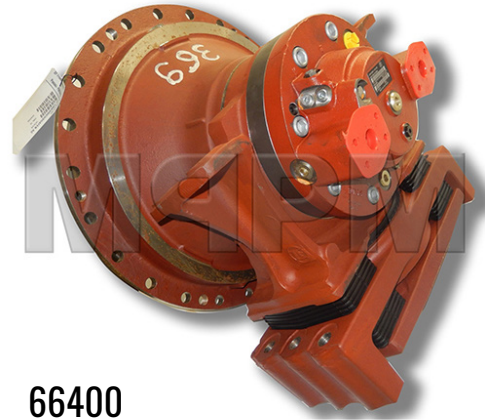

66400

| PART # | DESCRIPTION | LINK |
|--------|------------------------------|----------------------|
| 66075 | NEW Mixer Drum Drive Gearbox | link |

| PART # | DESCRIPTION | LINK |
|--------|--|----------------------|
| 66400 | CML 12 Gear Box Drum Drive - Ecomix II | link |

| | | |
|---------|--------------------------|----------------------|
| 66075RB | Rebuilt Exchange Gearbox | link |
|---------|--------------------------|----------------------|

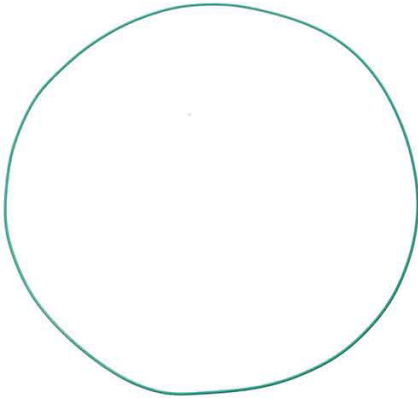

66401

| PART # | DESCRIPTION | LINK |
|--------|---------------------------|----------------------|
| 66401 | CML12 Output Cover O-ring | link |

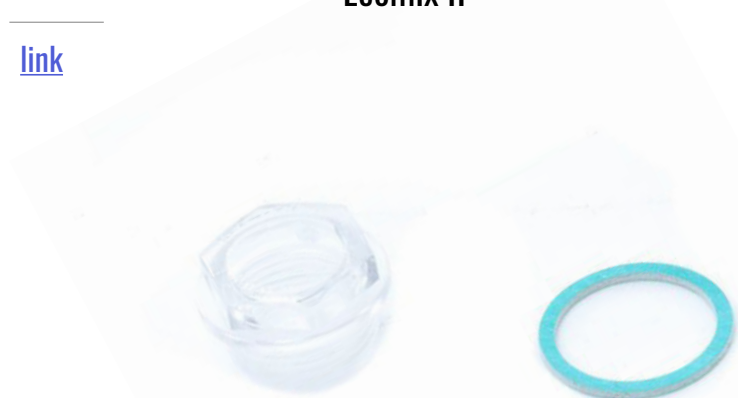

66403

| PART # | DESCRIPTION | LINK |
|--------|-----------------|----------------------|
| 66403 | Oil Level Gauge | link |



66405

| PART # | DESCRIPTION | LINK |
|--------|--------------------|----------------------|
| 66405 | CML12 Output Cover | link |



63000

| PART # | DESCRIPTION | LINK |
|--------|----------------------------------|----------------------|
| 63000 | Hydraulic Motor With Sensor Port | link |



64005

| PART # | DESCRIPTION | LINK |
|--------|-------------------------------|----------------------|
| 64005 | Start/Stop Drum Control Valve | link |

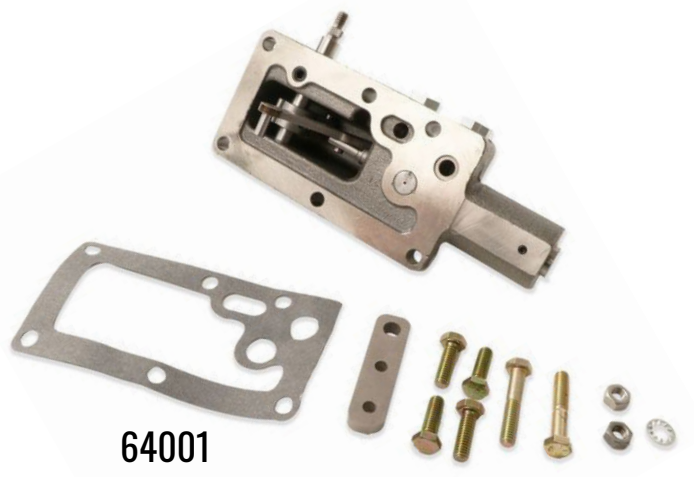

64001

| PART # | DESCRIPTION | LINK |
|---------|------------------------------|----------------------|
| 64001 | Manual Control Valve | link |
| 64001RB | Rebuilt Manual Control Valve | link |



64010P

| PART # | DESCRIPTION | LINK |
|--------|------------------------------------|----------------------|
| 64010P | Control Valve Lever Arm - 4in Bent | link |



64017

| PART # | DESCRIPTION | LINK |
|--------|-------------------------------|----------------------|
| 64017 | Eaton RE Control Valve Gasket | link |



64018

| PART # | DESCRIPTION | LINK |
|--------|--------------------------|----------------------|
| 64018 | Charge Pump Gasket A-Pad | link |



64022

| PART # | DESCRIPTION | LINK |
|--------|--------------------|----------------------|
| 64022 | Charge Pump Gasket | link |



64325



64400

| PART # | DESCRIPTION | LINK |
|--------|-------------|------|
|--------|-------------|------|

64325 Pressure Compensator Chute Pump [link](#)

| PART # | DESCRIPTION | LINK |
|--------|-------------|------|
|--------|-------------|------|

64400 Counter Clockwise Hydraulic Gear Pump [link](#)



64401

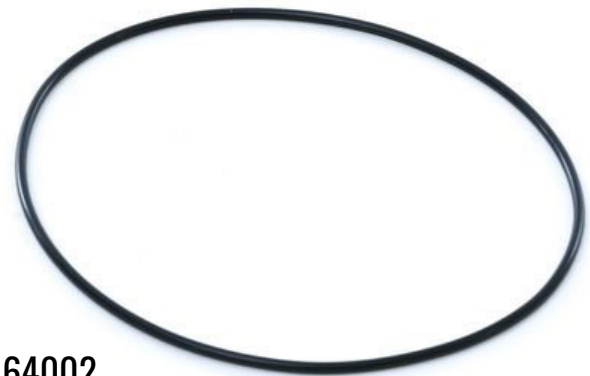

64002

| PART # | DESCRIPTION | LINK |
|--------|-------------|------|
|--------|-------------|------|

64401 Clockwise Hydraulic Gear Pump [link](#)

| PART # | DESCRIPTION | LINK |
|--------|-------------|------|
|--------|-------------|------|

64002 Pony Pump Oring [link](#)



64500



64520

| PART # | DESCRIPTION | LINK |
|--------|-------------|------|
|--------|-------------|------|

64500 Control Valve Gasket and Seal Kit [link](#)

| PART # | DESCRIPTION | LINK |
|--------|-------------|------|
|--------|-------------|------|

64520 Pump and Motor Shaft Seal Kit [link](#)

BECK HYDRAULIC SYSTEM PARTS

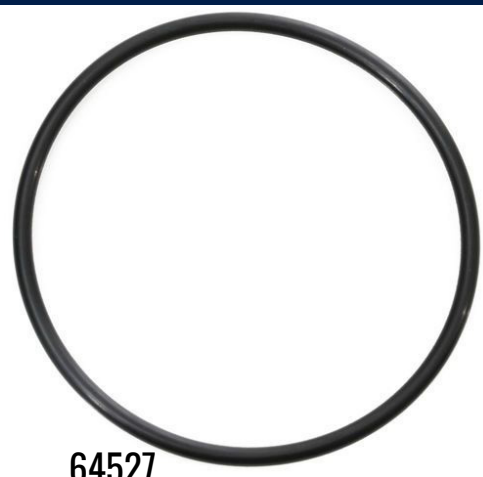

64527



64528

| PART # | DESCRIPTION | LINK |
|--------|-------------|------|
|--------|-------------|------|

| | | |
|-------|--------------------|----------------------|
| 64527 | Eaton Servo O-Ring | link |
|-------|--------------------|----------------------|

| PART # | DESCRIPTION | LINK |
|--------|-------------|------|
|--------|-------------|------|

| | | |
|-------|-------------------------|----------------------|
| 64528 | Eaton Pump Servo O-Ring | link |
|-------|-------------------------|----------------------|



64530



67010

| PART # | DESCRIPTION | LINK |
|--------|-------------|------|
|--------|-------------|------|

| | | |
|-------|------------------------------------|----------------------|
| 64530 | Hydraulic Pump Seal and Gasket Kit | link |
|-------|------------------------------------|----------------------|

| PART # | DESCRIPTION | LINK |
|--------|-------------|------|
|--------|-------------|------|

| | | |
|-------|---|----------------------|
| 67010 | Mixer Double Acting Chute Lift Cylinder | link |
|-------|---|----------------------|

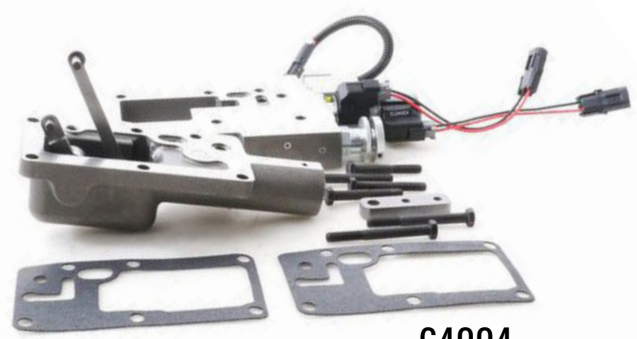

64004



64008

| PART # | DESCRIPTION | LINK |
|--------|-------------|------|
|--------|-------------|------|

| | | |
|-------|------------------------------------|----------------------|
| 64004 | RE Control with Manual Control Kit | link |
|-------|------------------------------------|----------------------|

| PART # | DESCRIPTION | LINK |
|--------|-------------|------|
|--------|-------------|------|

| | | |
|-------|---|----------------------|
| 64008 | Eaton RE Control Valve Cartridge - Charge-Discharge | link |
|-------|---|----------------------|



64009



64007

| PART # | DESCRIPTION | LINK |
|--------|-------------|------|
|--------|-------------|------|

64009 Charge Discharge Solenoid Coil [link](#)

| PART # | DESCRIPTION | LINK |
|--------|-------------|------|
|--------|-------------|------|

64007 Eaton RE Control Valve Cartridge - Start/Stop [link](#)

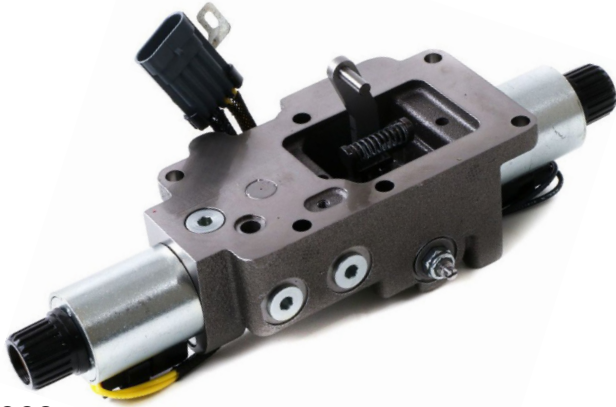

64003



65014

| PART # | DESCRIPTION | LINK |
|--------|-------------|------|
|--------|-------------|------|

64003 Eaton RE Control Valve [link](#)

| PART # | DESCRIPTION | LINK |
|--------|-------------|------|
|--------|-------------|------|

65014 U-Joint [link](#)



65028

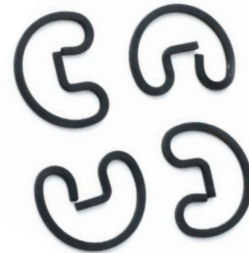

65029

| PART # | DESCRIPTION | LINK |
|--------|-------------|------|
|--------|-------------|------|

65028 Universal Joint [link](#)

| PART # | DESCRIPTION | LINK |
|--------|-------------|------|
|--------|-------------|------|

65029 U-Joint [link](#)

BECK HYDRAULIC SYSTEM PARTS



65205

| PART # | DESCRIPTION | LINK |
|--------|-------------|------|
|--------|-------------|------|

| | | |
|-------|------------------|----------------------|
| 65205 | Tapered End Yoke | link |
|-------|------------------|----------------------|



65210

| PART # | DESCRIPTION | LINK |
|--------|-------------|------|
|--------|-------------|------|

| | | |
|-------|---|----------------------|
| 65210 | Tapered End Yoke-1310 for 1-3/8in Tapered Shaft | link |
|-------|---|----------------------|



65310

| PART # | DESCRIPTION | LINK |
|--------|-------------|------|
|--------|-------------|------|

| | | |
|-------|-----------------------|----------------------|
| 65310 | U-Joint Bolt Kit 1350 | link |
|-------|-----------------------|----------------------|



65315

| PART # | DESCRIPTION | LINK |
|--------|-------------|------|
|--------|-------------|------|

| | | |
|-------|-----------------|----------------------|
| 65315 | U-Bolt Kit 1310 | link |
|-------|-----------------|----------------------|



90232100



90232300

| PART # | DESCRIPTION | LINK |
|--------|-------------|------|
|--------|-------------|------|

90232100 Single Acting Hydraulic Chute Block Assembly Manifold [link](#)

| PART # | DESCRIPTION | LINK |
|--------|-------------|------|
|--------|-------------|------|

90232300 Double Acting Chute Valve Block Assembly [link](#)



90232150

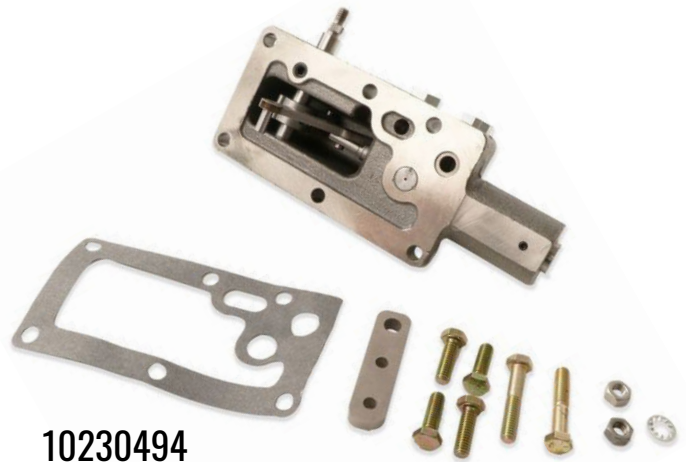

10230494

| PART # | DESCRIPTION | LINK |
|--------|-------------|------|
|--------|-------------|------|

90232150 Hydraulic Chute Block Seal Kit [link](#)

| PART # | DESCRIPTION | LINK |
|--------|-------------|------|
|--------|-------------|------|

10230494 NEW Pump Control Valve [link](#)



10230495

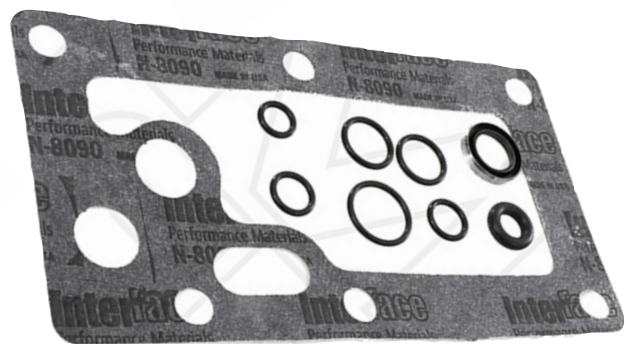

10230500

| PART # | DESCRIPTION | LINK |
|--------|-------------|------|
|--------|-------------|------|

10230495 Refurb Pump Control Valve [link](#)

| PART # | DESCRIPTION | LINK |
|--------|-------------|------|
|--------|-------------|------|

10230500 Gasket Seal Kit for Manual Eaton Control Valves [link](#)

CBMW HYDRAULIC SYSTEM PARTS

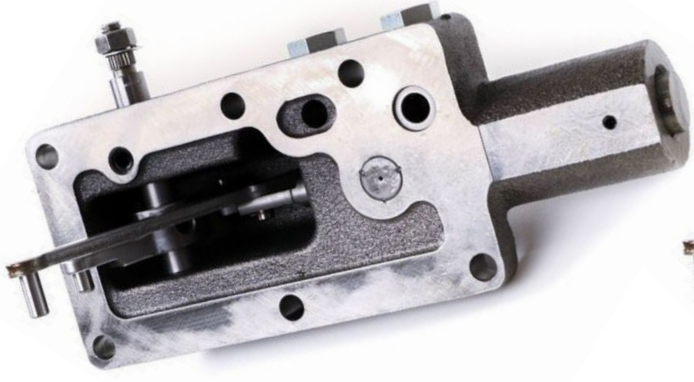

10230701

| PART # | DESCRIPTION | LINK |
|--------|-------------|------|
|--------|-------------|------|

| | | |
|----------|-------------------------------|----------------------|
| 10230701 | NEW Double Link Control Valve | link |
|----------|-------------------------------|----------------------|

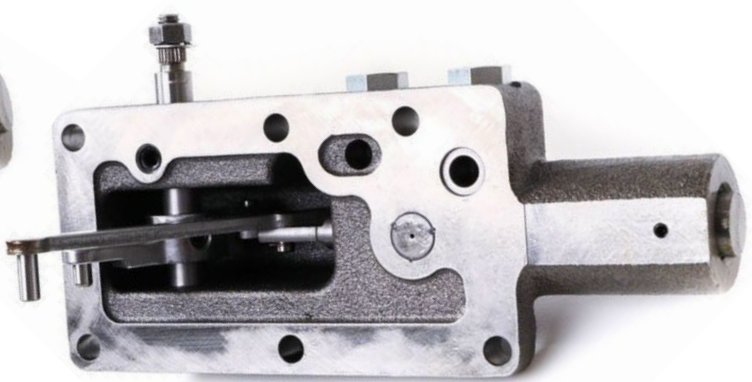

10230702

| PART # | DESCRIPTION | LINK |
|--------|-------------|------|
|--------|-------------|------|

| | | |
|----------|---------------------------------|----------------------|
| 10230702 | Reman Double Link Control Valve | link |
|----------|---------------------------------|----------------------|



10234912

| PART # | DESCRIPTION | LINK |
|--------|-------------|------|
|--------|-------------|------|

| | | |
|----------|-------------------------------|----------------------|
| 10234912 | Control Valve Shaft Dust Seal | link |
|----------|-------------------------------|----------------------|



90200200

| PART # | DESCRIPTION | LINK |
|--------|-------------|------|
|--------|-------------|------|

| | | |
|----------|-------------------------------|----------------------|
| 90200200 | Start/Stop Drum Control Valve | link |
|----------|-------------------------------|----------------------|

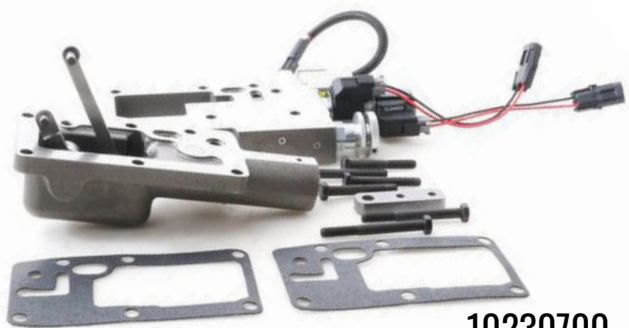

10230700

| PART # | DESCRIPTION | LINK |
|--------|-------------|------|
|--------|-------------|------|

| | | |
|----------|------------------------------------|----------------------|
| 10230700 | RE Control with Manual Control Kit | link |
|----------|------------------------------------|----------------------|

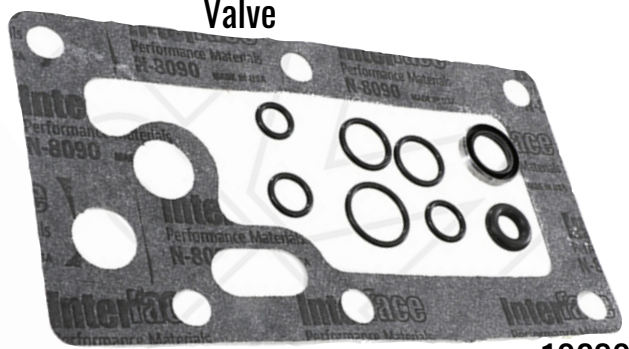

10230600

| PART # | DESCRIPTION | LINK |
|--------|-------------|------|
|--------|-------------|------|

| | | |
|----------|---|----------------------|
| 10230500 | Gasket Seal Kit for Manual Eaton Control Valves | link |
|----------|---|----------------------|



10230607

| PART # | DESCRIPTION | LINK |
|--------|-------------|------|
|--------|-------------|------|

10230607 RE Mixer Control Valve Charge Discharge Solenoid Coil [link](#)



10230608

| PART # | DESCRIPTION | LINK |
|--------|-------------|------|
|--------|-------------|------|

10230608 Chute Up/Down Solenoid Coil [link](#)

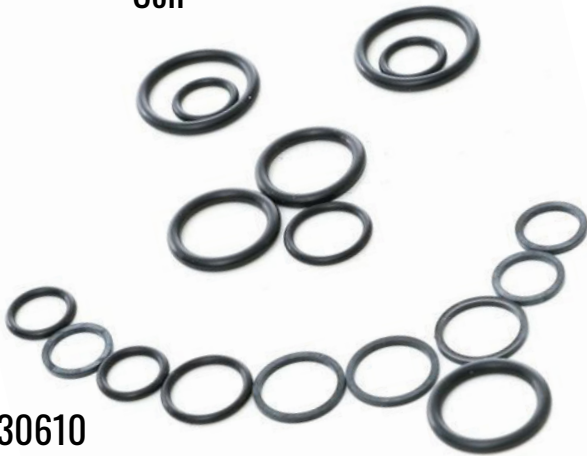

10230610

| PART # | DESCRIPTION | LINK |
|--------|-------------|------|
|--------|-------------|------|

90232150 Hydraulic Chute Block Seal Kit [link](#)



10230611

| PART # | DESCRIPTION | LINK |
|--------|-------------|------|
|--------|-------------|------|

10230611 RE Control Valve Cartridge [link](#)

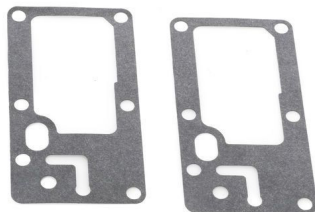

10230620

| PART # | DESCRIPTION | LINK |
|--------|-------------|------|
|--------|-------------|------|

10230620 Eaton RE Control Valve Gasket and Seal Kit** [link](#)



10230498

| PART # | DESCRIPTION | LINK |
|--------|-------------|------|
|--------|-------------|------|

10230498 Shaft Seal Kit for 33-54 Series Pumps [link](#)

**NOTE: Uses 1 EA 10230493 and 1 EA 10230601 Gasket

CBMW HYDRAULIC SYSTEM PARTS



10231498

| PART # | DESCRIPTION | LINK |
|--------|-------------|------|
|--------|-------------|------|

| | | |
|----------|-------------------------------|----------------------|
| 10231498 | Pump and Motor Shaft Seal Kit | link |
|----------|-------------------------------|----------------------|



10230505

| PART # | DESCRIPTION | LINK |
|--------|-------------|------|
|--------|-------------|------|

| | | |
|----------|------------------------------------|----------------------|
| 10230505 | Sundstrand Pump Seal Kit 23 Series | link |
|----------|------------------------------------|----------------------|



10230506

| PART # | DESCRIPTION | LINK |
|--------|-------------|------|
|--------|-------------|------|

| | | |
|----------|---|----------------------|
| 10230506 | Sundstrand Pump Seal Kit 21 & 22 Series | link |
|----------|---|----------------------|



10230233

| PART # | DESCRIPTION | LINK |
|--------|-------------|------|
|--------|-------------|------|

| | | |
|----------|--|----------------------|
| 10230233 | Sundstrand Control Valve Gasket and Seal Kit | link |
|----------|--|----------------------|

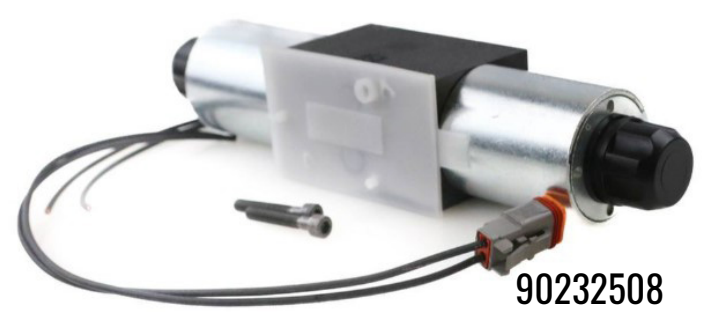

90232508

| PART # | DESCRIPTION | LINK |
|--------|-------------|------|
|--------|-------------|------|

| | | |
|----------|---|----------------------|
| 90232508 | Control Valve for Axle Up Down and Axle Stop Go | link |
|----------|---|----------------------|



90232509

| PART # | DESCRIPTION | LINK |
|--------|-------------|------|
|--------|-------------|------|

| | | |
|----------|--|----------------------|
| 90232509 | Control Valve for Chute Cylinder Up and Down | link |
|----------|--|----------------------|



80232102



80232201

| PART # | DESCRIPTION | LINK |
|--------|-------------|------|
|--------|-------------|------|

80232102 Hydraulic Chute Up Solenoid [link](#)

| PART # | DESCRIPTION | LINK |
|--------|-------------|------|
|--------|-------------|------|

80232201 Chute Solenoid Valve With Coil and Plug [link](#)



80232101



80232104

| PART # | DESCRIPTION | LINK |
|--------|-------------|------|
|--------|-------------|------|

80232101 Hydraulic Chute Solenoid Valve [link](#)

| PART # | DESCRIPTION | LINK |
|--------|-------------|------|
|--------|-------------|------|

80232104 Chute Flow Control Valve [link](#)



80233432

| PART # | DESCRIPTION | LINK |
|--------|-------------|------|
|--------|-------------|------|

80233432 Hydraulic Counter Balance Valve [link](#)



80232108

| PART # | DESCRIPTION | LINK |
|--------|-------------|------|
|--------|-------------|------|

80232108 Hyd Chute Block Check Valve - 5 psi [link](#)

CBMW HYDRAULIC SYSTEM PARTS

| PART # | DESCRIPTION | LINK |
|--------|-------------|------|
|--------|-------------|------|

80232109 200psi Hydraulic Chute Check Valve [link](#)



80232303

| PART # | DESCRIPTION | LINK |
|--------|-------------|------|
|--------|-------------|------|

80232303 Chute Flow Control Needle Valve - Up [link](#)

90232503

| PART # | DESCRIPTION | LINK |
|--------|-------------|------|
|--------|-------------|------|

90232503 Single Pilot Check Valve [link](#)



90232506

| PART # | DESCRIPTION | LINK |
|--------|-------------|------|
|--------|-------------|------|

90232506 2200 psi Relief Valve [link](#)

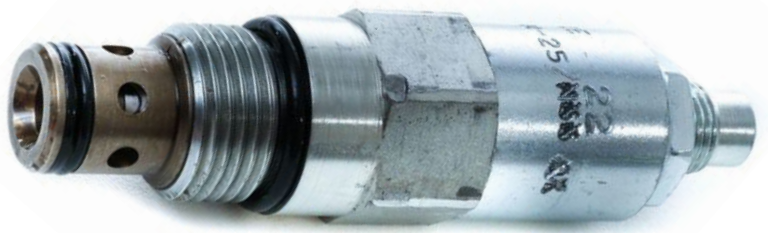

90232505

| PART # | DESCRIPTION | LINK |
|--------|-------------|------|
|--------|-------------|------|

90232505 Hydraforce Pressure Reducing Valve 90232511 Less Knob [link](#)

80230040

| PART # | DESCRIPTION | LINK |
|--------|-------------|------|
|--------|-------------|------|

80230040 Pressure Valve With Knob [link](#)



| PART # | DESCRIPTION | LINK |
|--------|-------------|------|
|--------|-------------|------|

80200722 Fuse Valve

[link](#)



80230021

| PART # | DESCRIPTION | LINK |
|--------|-------------|------|
|--------|-------------|------|

80230021 PTS Valve with Internal Drain [link](#)



80200200



90232510

| PART # | DESCRIPTION | LINK |
|--------|-------------|------|
|--------|-------------|------|

90232510 Pressure Reducing Valve Knob From 90232511 [link](#)

[link](#)



80200721

| PART # | DESCRIPTION | LINK |
|--------|-------------|------|
|--------|-------------|------|

80200721 2.5 inch Hydraulic Panel Mount Pressure Gauge [link](#)

[link](#)

| PART # | DESCRIPTION | LINK |
|--------|-------------|------|
|--------|-------------|------|

80200200 General Seal Kit [link](#)

[link](#)



10210200

| PART # | DESCRIPTION | LINK |
|--------|-------------|------|
|--------|-------------|------|

10210200 Hydraulic Gear Pump - CCW LH Rotation [link](#)

[link](#)

CBMW HYDRAULIC SYSTEM PARTS



10210300

| PART # | DESCRIPTION | LINK |
|----------|--------------------------------------|----------------------|
| 10210300 | Hydraulic Gear Pump - CW RH Rotation | link |

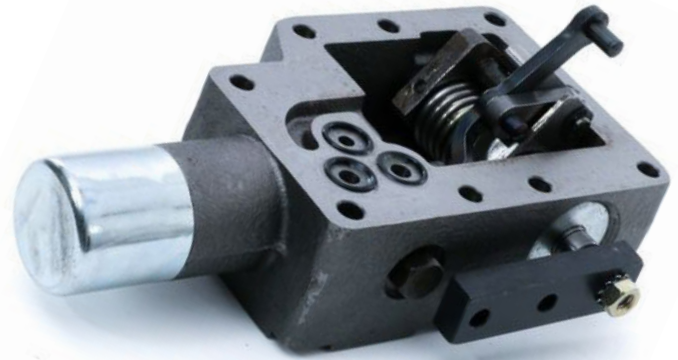

10230501

| PART # | DESCRIPTION | LINK |
|----------|--------------------------|----------------------|
| 10230501 | Sundstrand Control Valve | link |



10210400

| PART # | DESCRIPTION | LINK |
|----------|-------------------------------|----------------------|
| 10210400 | CCW Pressure Compensator Pump | link |



10210600

| PART # | DESCRIPTION | LINK |
|----------|------------------------------|----------------------|
| 10210600 | CW Pressure Compensator Pump | link |



10210020

| PART # | DESCRIPTION | LINK |
|----------|---------------------------|----------------------|
| 10210020 | CW Charge Pump With A-Pad | link |

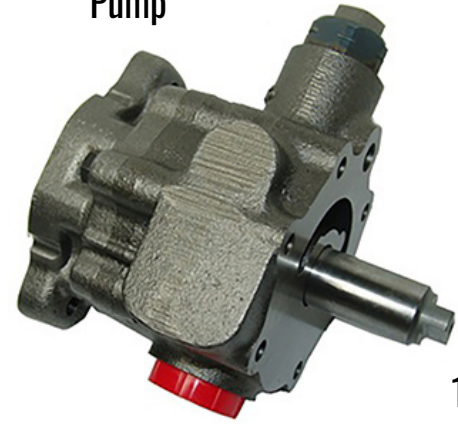

10210030

| PART # | DESCRIPTION | LINK |
|----------|--------------------------------|----------------------|
| 10210030 | CCW A-Pad Charge Pump Assembly | link |



10210201

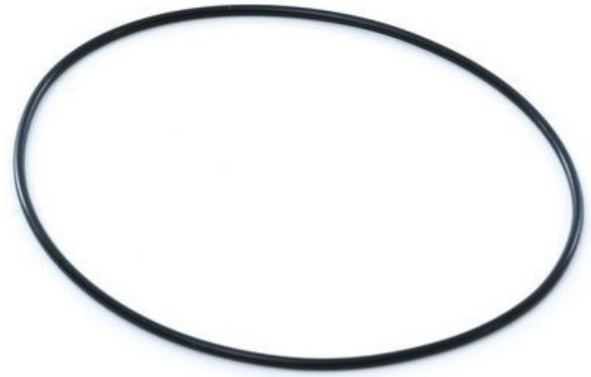

10210202

| PART # | DESCRIPTION | LINK |
|----------|------------------------------------|----------------------|
| 10210201 | Eaton APad Pony Charge Pump Gasket | link |

| PART # | DESCRIPTION | LINK |
|----------|--------------------------|----------------------|
| 10210202 | Buna N70 Pony Pump Oring | link |



10201442



90200125

| PART # | DESCRIPTION | LINK |
|----------|----------------|----------------------|
| 10201442 | Spin-on Filter | link |

| PART # | DESCRIPTION | LINK |
|----------|--|----------------------|
| 90200125 | 25 Micron In-Line High Pressure Filter | link |



10200501

| PART # | DESCRIPTION | LINK |
|----------|---|----------------------|
| 10200501 | Hydraulic HP Filter Element 15P Element | link |



10200565

| PART # | DESCRIPTION | LINK |
|----------|---------------------------------------|----------------------|
| 10210200 | Hydraulic Gear Pump - CCW LH Rotation | link |

CBMW HYDRAULIC SYSTEM PARTS



90200051



90251201

| PART # | DESCRIPTION | LINK |
|--------|-------------|------|
|--------|-------------|------|

90200051 Hydraulic HP Filter Element [link](#)

| PART # | DESCRIPTION | LINK |
|--------|-------------|------|
|--------|-------------|------|

90251201 Nitrogen Pressure Gauge [link](#)



90240041



90240001

| PART # | DESCRIPTION | LINK |
|--------|-------------|------|
|--------|-------------|------|

90240041 Sight Gauge for Round Hydraulic Tanks [link](#)

| PART # | DESCRIPTION | LINK |
|--------|-------------|------|
|--------|-------------|------|

90240001 Breather Cap - 3/4 inch NPT for Hydraulic Tanks [link](#)



10202502



10251510

| PART # | DESCRIPTION | LINK |
|--------|-------------|------|
|--------|-------------|------|

10202502 Hyd Chute Pressure Switch [link](#)

| PART # | DESCRIPTION | LINK |
|--------|-------------|------|
|--------|-------------|------|

10251510 Hydraulic Cylinder [link](#)



80254733

| PART # | DESCRIPTION | LINK |
|----------|------------------------------------|----------------------|
| 80254733 | Hydraulic Cylinder - Single Acting | link |



80256733

| PART # | DESCRIPTION | LINK |
|----------|---|----------------------|
| 80256733 | Mixer Double Acting Chute Lift Cylinder | link |



90252614

| PART # | DESCRIPTION | LINK |
|----------|--|----------------------|
| 90252614 | Single Acting Hydraulic Chute Cylinder | link |



90253214

| PART # | DESCRIPTION | LINK |
|----------|---|----------------------|
| 90253214 | Double Acting Hydraulic Chute Lift Cylinder | link |



80251150

| PART # | DESCRIPTION | LINK |
|----------|---|----------------------|
| 80251150 | BMV Hydraulic Cylinder Rebuild Exchange | link |



90251150

| PART # | DESCRIPTION | LINK |
|----------|--|----------------------|
| 90251150 | NEW 4.5in x 4.5in x 31.88in Bridgmaster Cylinder | link |

CBMW HYDRAULIC SYSTEM PARTS



90251200



10630642

| PART # | DESCRIPTION | LINK |
|--------|-------------|------|
|--------|-------------|------|

| | | |
|----------|-------------------------------|----------------------|
| 90251200 | BMIII Remanufactured Cylinder | link |
|----------|-------------------------------|----------------------|

| | | |
|----------|--------------------------------------|----------------------|
| 10251150 | Bridge Commander 2" Bearing Cylinder | link |
|----------|--------------------------------------|----------------------|

| PART # | DESCRIPTION | LINK |
|--------|-------------|------|
|--------|-------------|------|

| | | |
|----------|--------------------------|----------------------|
| 10630642 | Flange Yoke Adapter 1310 | link |
|----------|--------------------------|----------------------|



10630643



10630637

| PART # | DESCRIPTION | LINK |
|--------|-------------|------|
|--------|-------------|------|

| | | |
|----------|--------------------------|----------------------|
| 10630643 | Flange Yoke for PTO 1310 | link |
|----------|--------------------------|----------------------|

| PART # | DESCRIPTION | LINK |
|--------|-------------|------|
|--------|-------------|------|

| | | |
|----------|------------------------|----------------------|
| 10630637 | Universal Joint - 1350 | link |
|----------|------------------------|----------------------|



10630639



10630640

| PART # | DESCRIPTION | LINK |
|--------|-------------|------|
|--------|-------------|------|

| | | |
|----------|---------|----------------------|
| 10630639 | U-Joint | link |
|----------|---------|----------------------|

| PART # | DESCRIPTION | LINK |
|--------|-------------|------|
|--------|-------------|------|

| | | |
|----------|----------------------|----------------------|
| 10630640 | Universal Joint 1310 | link |
|----------|----------------------|----------------------|



10630641



10630645

| PART # | DESCRIPTION | LINK |
|--------|-------------|------|
|--------|-------------|------|

10630641 Universal Joint - Maintenance Free 1310 [link](#)

| PART # | DESCRIPTION | LINK |
|--------|-------------|------|
|--------|-------------|------|

10630645 Greaseable 1350 U-Joint [link](#)



10630634



10632634

| PART # | DESCRIPTION | LINK |
|--------|-------------|------|
|--------|-------------|------|

10630634 Tapered End Yoke [link](#)

| PART # | DESCRIPTION | LINK |
|--------|-------------|------|
|--------|-------------|------|

10632634 Tapered End Yoke [link](#)



10630636



| PART # | DESCRIPTION | LINK |
|--------|-------------|------|
|--------|-------------|------|

10630636 U-Joint Bolt Kit [link](#)



10630638

| PART # | DESCRIPTION | LINK |
|--------|-------------|------|
|--------|-------------|------|

10630638 U-Joint Bolt Kit [link](#)



80240030

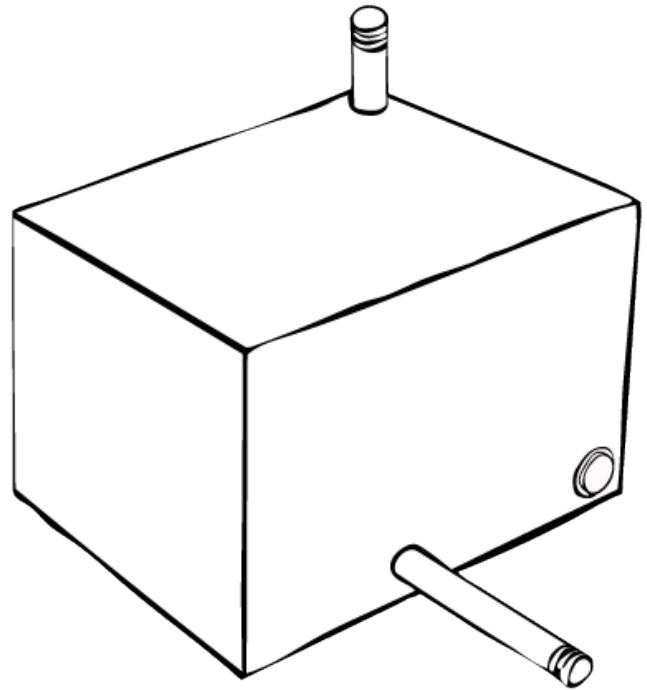

80240273

| PART # | DESCRIPTION | LINK |
|----------|------------------------------|----------------------|
| 80240030 | Hydraulic Oil Tank Reservoir | link |

| PART # | DESCRIPTION | LINK |
|----------|-------------------------------------|----------------------|
| 80240273 | Square Hydraulic Oil Tank Reservoir | link |

| PART # | DESCRIPTION | LINK |
|----------|-------------------------|----------------------|
| 90240140 | Hydraulic Oil Reservoir | link |

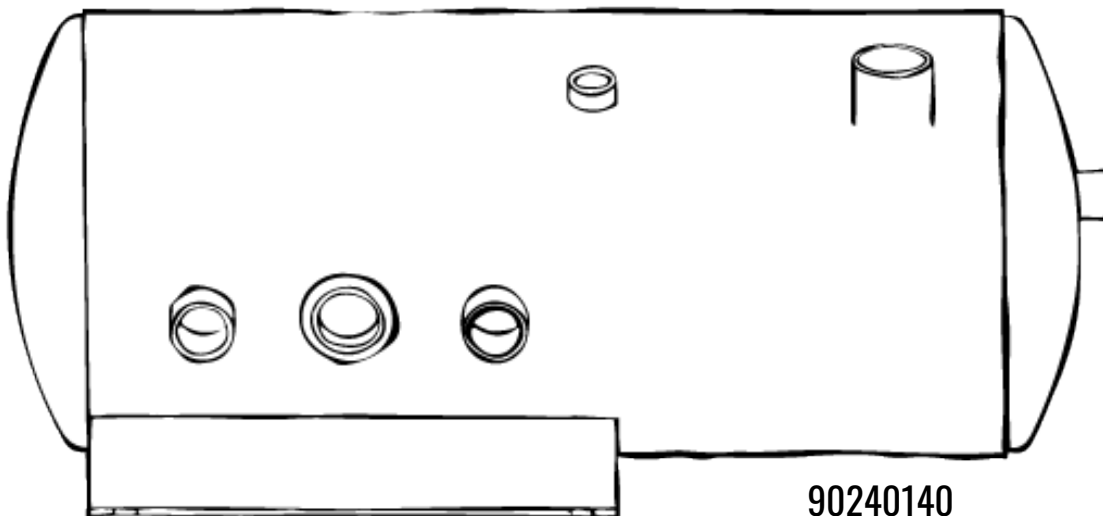

90240140



70625

| PART # | DESCRIPTION | LINK |
|--------|--|----------------------|
| 70625 | Dyna Chute Power Unit with Manual Handle | link |



70719

| PART # | DESCRIPTION | LINK |
|--------|---|----------------------|
| 70719 | Power Unit-Push Button/ Electric Chute Lifter | link |



| PART # | DESCRIPTION | LINK |
|----------|-----------------|----------------------|
| 10771700 | ZT PM90 Gearbox | link |



10770106

| PART # | DESCRIPTION | LINK |
|----------|--|----------------------|
| 10770106 | ZT Gearbox Main Bearing - Output Shaft | link |

Fits: 10771700, 10777700EX

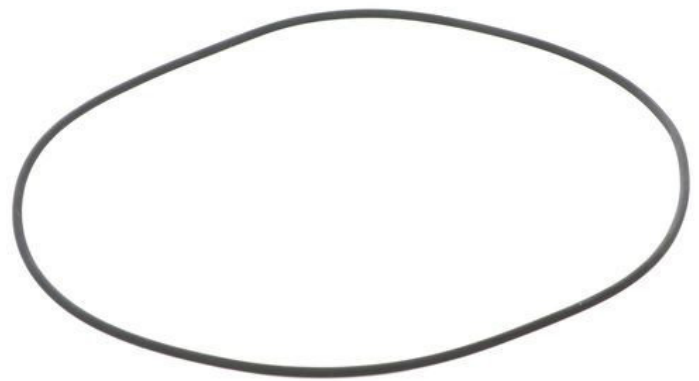

10770214

| PART # | DESCRIPTION | LINK |
|----------|----------------------|----------------------|
| 10770214 | 170x3 Gearbox O-Ring | link |

Fits: 10771700, 10777700EX

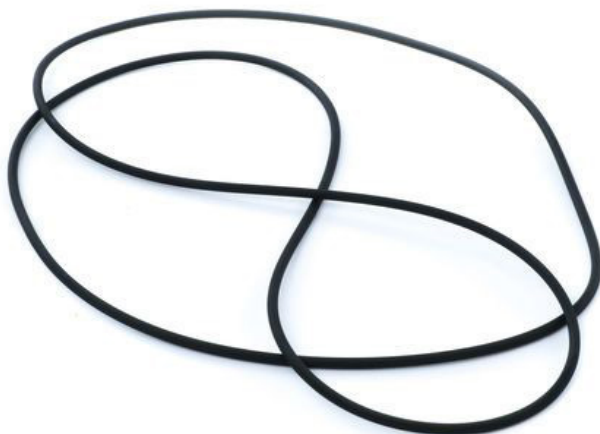

10770213

| PART # | DESCRIPTION | LINK |
|----------|--------------------------------|----------------------|
| 10770213 | ZT Gearbox O-Ring (2 required) | link |

Fits: 10771700

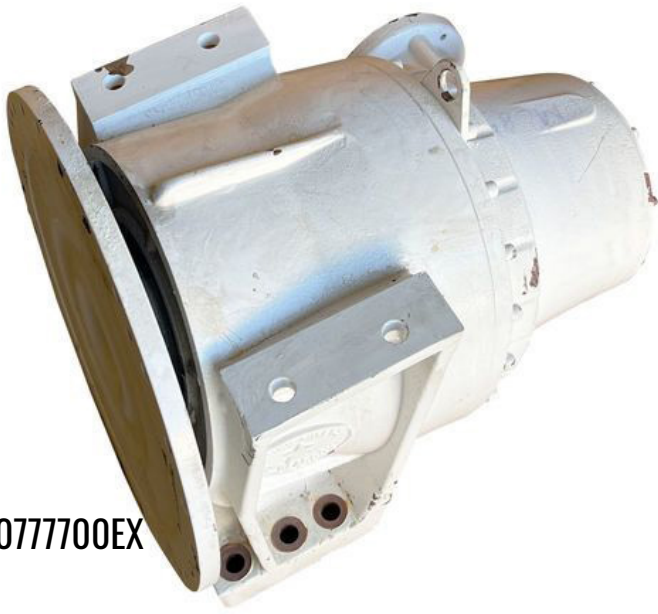

1077700EX

| PART # | DESCRIPTION | LINK |
|--------|-------------|------|
|--------|-------------|------|

| | | |
|-----------|---|----------------------|
| 1077700EX | ZT PML90 Gearbox - Right Angle Rebuilt Exchange | link |
|-----------|---|----------------------|



10770215

| PART # | DESCRIPTION | LINK |
|--------|-------------|------|
|--------|-------------|------|

| | | |
|----------|-------------------|----------------------|
| 10770215 | ZT Gearbox O-Ring | link |
|----------|-------------------|----------------------|

Fits: 10771700, 1077700EX



10770735

| PART # | DESCRIPTION | LINK |
|--------|-------------|------|
|--------|-------------|------|

| | | |
|----------|---|----------------------|
| 10770735 | Plastic Hydraulic Gearbox Oil Sight Gauge | link |
|----------|---|----------------------|

Fits: 1077700EX



10750102

| PART # | DESCRIPTION | LINK |
|--------|-------------|------|
|--------|-------------|------|

| | | |
|----------|----------------------|----------------------|
| 10750102 | ZT Gearbox Main Seal | link |
|----------|----------------------|----------------------|

Fits: 10771700, 1077700EX

CON-TECH HYDRAULIC SYSTEM PARTS



745003

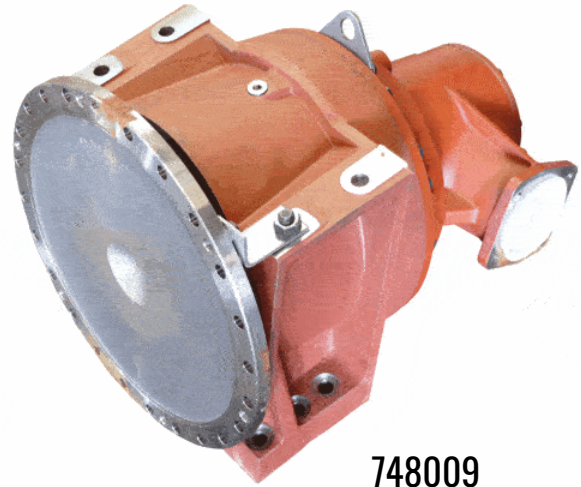

748009

| PART # | DESCRIPTION | LINK |
|--------|----------------------|----------------------|
| 745003 | NEW ZF P7300 Drive | link |
| 748008 | REMAN ZF P7300 Drive | link |

| PART # | DESCRIPTION | LINK |
|--------|--------------------------|----------------------|
| 748009 | Mixer Drum Drive Gearbox | link |



745005

| PART # | DESCRIPTION | LINK |
|--------|------------------------------------|----------------------|
| 745005 | ZF PK7500 Gearbox-Rebuilt Exchange | link |



748010

| PART # | DESCRIPTION | LINK |
|--------|--------------------------------|----------------------|
| 748010 | Drum Drive Gearbox - Ecomix II | link |

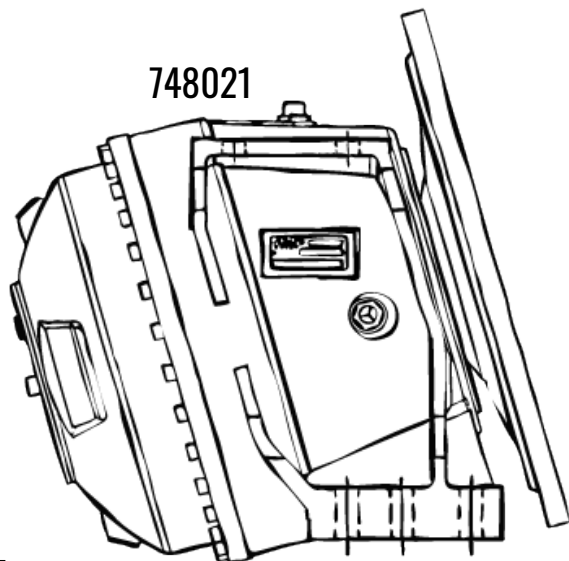

748021

| PART # | DESCRIPTION | LINK |
|--------|------------------|----------------------|
| 748021 | Gearbox Drum 7.1 | link |



745509



748015

| PART # | DESCRIPTION | LINK |
|--------|-------------|----------------------|
| 745509 | Screw Plug | link |

| PART # | DESCRIPTION | LINK |
|--------|--------------|----------------------|
| 748015 | Breather Cap | link |



730600



745503

| PART # | DESCRIPTION | LINK |
|--------|-------------|----------------------|
| 730600 | Re-Seal | link |

| PART # | DESCRIPTION | LINK |
|--------|----------------------------|----------------------|
| 745503 | Drum Drive Vented Dipstick | link |



745505



745506

| PART # | DESCRIPTION | LINK |
|--------|--------------------------------------|----------------------|
| 745505 | Mixer Drum Drive Gearbox Sight Gauge | link |

| PART # | DESCRIPTION | LINK |
|--------|-----------------|----------------------|
| 745506 | Oil Level Gauge | link |

CON-TECH HYDRAULIC SYSTEM PARTS



745500

| PART # | DESCRIPTION | LINK |
|--------|---------------|----------------------|
| 745500 | ZF Shaft Seal | link |



745504

| PART # | DESCRIPTION | LINK |
|--------|----------------------|----------------------|
| 745504 | Gearbox Main Bearing | link |



745508

| PART # | DESCRIPTION | LINK |
|--------|----------------------|----------------------|
| 745508 | Gearbox Main Bearing | link |



705100

| PART # | DESCRIPTION | LINK |
|--------|-------------|----------------------|
| 705100 | Slotted Nut | link |

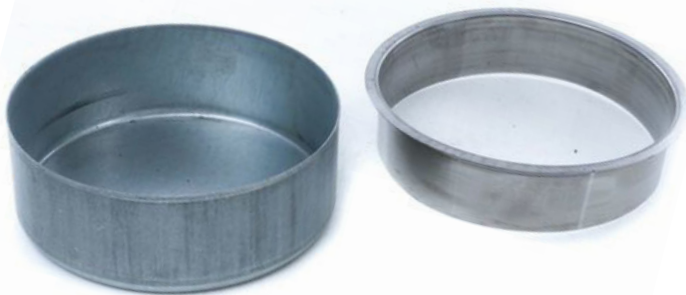

720040

| PART # | DESCRIPTION | LINK |
|--------|-------------------------|----------------------|
| 720040 | Main Seal Speedi Sleeve | link |

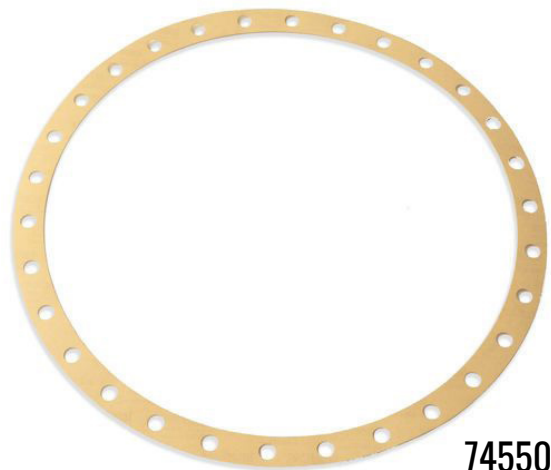

745501

| PART # | DESCRIPTION | LINK |
|--------|----------------|----------------------|
| 745501 | Gearbox Gasket | link |



725054

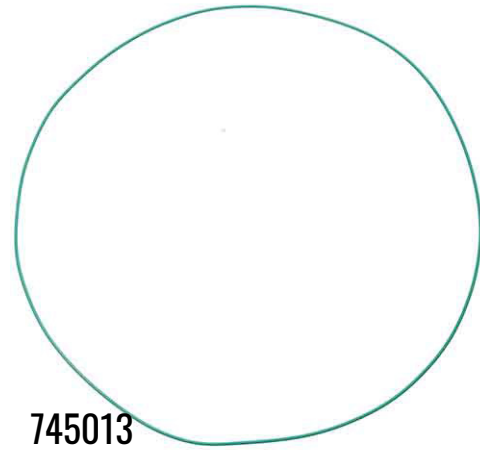

745013

| PART # | DESCRIPTION | LINK |
|--------|---------------------------|----------------------|
| 725054 | Transmittal Breather Plug | link |

| PART # | DESCRIPTION | LINK |
|--------|---------------------------|----------------------|
| 745013 | CML12 Output Cover O-Ring | link |



730601



745014

| PART # | DESCRIPTION | LINK |
|--------|----------------------------|----------------------|
| 730601 | Ecofluid Gear Oil 20 Liter | link |

| PART # | DESCRIPTION | LINK |
|--------|--------------------|----------------------|
| 745014 | CML12 Output Cover | link |



740009



740010

| PART # | DESCRIPTION | LINK |
|--------|---|----------------------|
| 740009 | Hydraulic Oil Cooler Fan Motor Assembly | link |

| PART # | DESCRIPTION | LINK |
|--------|--|----------------------|
| 740010 | Hydraulic Cooler Assembly - Bottom Ports | link |

CON-TECH HYDRAULIC SYSTEM PARTS



715014

| PART # | DESCRIPTION | LINK |
|--------|---------------------------|----------------------|
| 715014 | Hayden Fan Motor Assembly | link |



715154

| PART # | DESCRIPTION | LINK |
|--------|---|----------------------|
| 715154 | Relay with Harness for 740010 ASA Oil Coolers | link |



715015

| PART # | DESCRIPTION | LINK |
|--------|---|----------------------|
| 715015 | Hydraulic Cooler Upper Thermal Temperature Switch | link |



715016

| PART # | DESCRIPTION | LINK |
|--------|---|----------------------|
| 715016 | Hydraulic Cooler Lower Thermal Temperature Switch | link |



715091

| PART # | DESCRIPTION | LINK |
|--------|---|----------------------|
| 715091 | Oil Temperature Sensor - On/215 Degrees MCL | link |



760402

| PART # | DESCRIPTION | LINK |
|--------|--|----------------------|
| 760402 | Combo Block Assembly with Bridgmaster Stop | link |

CON-TECH HYDRAULIC SYSTEM PARTS

| PART # | DESCRIPTION | LINK |
|--------|-------------|------|
|--------|-------------|------|

760154 Combo Block [link](#)

| PART # | DESCRIPTION | LINK |
|--------|-------------|------|
|--------|-------------|------|

760420 Combo Block Plug/Seal Kit [link](#)

| PART # | DESCRIPTION | LINK |
|--------|-------------|------|
|--------|-------------|------|

760199 Coil Retainer Nut [link](#)

| PART # | DESCRIPTION | LINK |
|--------|-------------|------|
|--------|-------------|------|

740004 Parker Valve Block Off Plate [link](#)



760158

| PART # | DESCRIPTION | LINK |
|--------|-------------|------|
|--------|-------------|------|

760158 Directional Control Valve - D03 Deutsch Conn Style [link](#)



760156

| PART # | DESCRIPTION | LINK |
|--------|-------------|------|
|--------|-------------|------|

760156 Directional Control Valve Coil for 760158 Directional Valve [link](#)



760421

| PART # | DESCRIPTION | LINK |
|--------|-------------|------|
|--------|-------------|------|

760421 Seal Kit [link](#)



760015

| PART # | DESCRIPTION | LINK |
|--------|-------------|------|
|--------|-------------|------|

760015 Directional Control Valve [link](#)



760165

| PART # | DESCRIPTION | LINK |
|--------|-------------|------|
|--------|-------------|------|

760165 Chute Up-Down Solenoid Coil [link](#)

CON-TECH HYDRAULIC SYSTEM PARTS

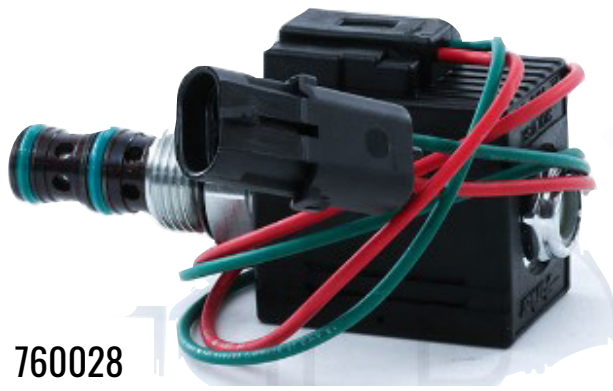

760028

| PART # | DESCRIPTION | LINK |
|--------|---|----------------------|
| 760028 | Chute Solenoid Valve With Coil and Plug | link |



760027

| PART # | DESCRIPTION | LINK |
|--------|---|----------------------|
| 760027 | Axle Pressure Valve Cartridge With Knob | link |



760159

| PART # | DESCRIPTION | LINK |
|--------|--------------------------|----------------------|
| 760159 | Chute Flow Control Valve | link |



760423

| PART # | DESCRIPTION | LINK |
|--------|---|----------------------|
| 760423 | Hex Socket Male O-Ring Boss Plug Fitting #2 | link |



760160

| PART # | DESCRIPTION | LINK |
|--------|--------------------------------------|----------------------|
| 760160 | Chute Flow Control Needle Valve - Up | link |



760095

| PART # | DESCRIPTION | LINK |
|--------|--------------------------|----------------------|
| 760095 | Single Pilot Check Valve | link |



760161

| PART # | DESCRIPTION | LINK |
|--------|-------------------------------------|----------------------|
| 760161 | Hyd Chute Block Check Valve - 5 psi | link |



735010

| PART # | DESCRIPTION | LINK |
|--------|-----------------------------------|----------------------|
| 735010 | High Pressure Oil Filter Assembly | link |



735003

| PART # | DESCRIPTION | LINK |
|--------|---|----------------------|
| 735003 | Hydraulic HP Filter Element 15P Element | link |



760037

| PART # | DESCRIPTION | LINK |
|--------|---|----------------------|
| 760037 | By-Pass Oil Filter Indicator for 108550 | link |



725019

| PART # | DESCRIPTION | LINK |
|--------|--|----------------------|
| 725019 | High Pressure Oil Filter O-Ring - 15P Parker | link |



725029

| PART # | DESCRIPTION | LINK |
|--------|---------------------------------------|----------------------|
| 725029 | Directional Control Valve Base O-Ring | link |

CON-TECH HYDRAULIC SYSTEM PARTS



760024

| PART # | DESCRIPTION | LINK |
|--------|---|----------------------|
| 760024 | 2.5 inch Hydraulic Panel Mount Pressure Gauge | link |

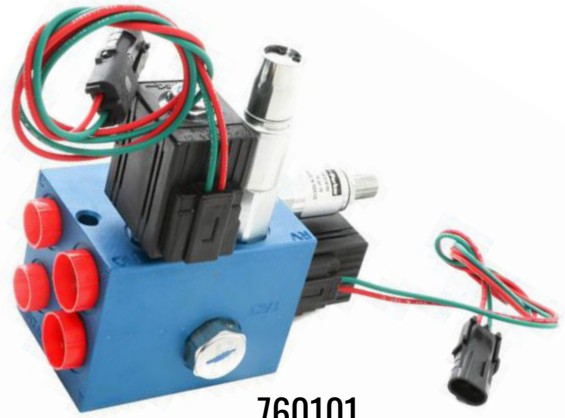

760101

| PART # | DESCRIPTION | LINK |
|--------|---|----------------------|
| 760101 | Hydraulic Chute Valve Block - Single Acting Open Center | link |



760100

| PART # | DESCRIPTION | LINK |
|--------|---------------------------------------|----------------------|
| 760100 | Double Acting Open Center Chute Block | link |

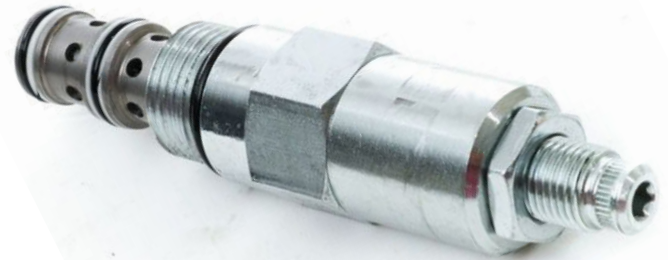

765091

| PART # | DESCRIPTION | LINK |
|--------|-----------------|----------------------|
| 765091 | Up Flow Control | link |



760159

| PART # | DESCRIPTION | LINK |
|--------|--------------------------|----------------------|
| 760159 | Chute Flow Control Valve | link |



765095

| PART # | DESCRIPTION | LINK |
|--------|-----------------------|----------------------|
| 765095 | 2200 psi Relief Valve | link |



760150



760011

| PART # | DESCRIPTION | LINK |
|--------|-----------------------------|----------------------|
| 760011 | Hydraulic Chute Up Solenoid | link |



760012

| PART # | DESCRIPTION | LINK |
|--------|--------------------------------|----------------------|
| 760012 | Hydraulic Chute Solenoid Valve | link |

| PART # | DESCRIPTION | LINK |
|--------|------------------|----------------------|
| 760150 | Chute Down Valve | link |



760403

| PART # | DESCRIPTION | LINK |
|--------|-------------------------------|----------------------|
| 760403 | Bridgmaster V High Flow Block | link |



760155

| PART # | DESCRIPTION | LINK |
|--------|--------------------------------------|----------------------|
| 760155 | Motion Control Valve Block - Rod End | link |

CON-TECH HYDRAULIC SYSTEM PARTS



760162

| PART # | DESCRIPTION | LINK |
|--------|--|----------------------|
| 760162 | High Pressure Relief Valve 3300 PSI Size 16 | link |



760163

| PART # | DESCRIPTION | LINK |
|--------|-------------------------------|----------------------|
| 760163 | PTS Valve with Internal Drain | link |



760157

| PART # | DESCRIPTION | LINK |
|--------|------------------------------------|----------------------|
| 760157 | Hydraulic Counter Balance Valve | link |



760161

| PART # | DESCRIPTION | LINK |
|--------|--|----------------------|
| 760161 | Hyd Chute Block Check Valve - 5 psi | link |



600032

| PART # | DESCRIPTION | LINK |
|--------|--------------------------------------|----------------------|
| 600032 | Throttle Pressure Switch Assembly | link |



715006

| PART # | DESCRIPTION | LINK |
|--------|-----------------|----------------------|
| 715006 | Pressure Switch | link |



715096

| PART # | DESCRIPTION | LINK |
|--------|-------------|------|
|--------|-------------|------|

| | | |
|--------|-----------------|----------------------|
| 715096 | Pressure Switch | link |
|--------|-----------------|----------------------|

| PART # | DESCRIPTION | LINK |
|--------|-------------|------|
|--------|-------------|------|

| | | |
|--------|----------------|----------------------|
| 735150 | Filter Element | link |
|--------|----------------|----------------------|



735000

| PART # | DESCRIPTION | LINK |
|--------|-------------|------|
|--------|-------------|------|

| | | |
|--------|------------------------------|----------------------|
| 735000 | Hydraulic Spin On Oil Filter | link |
|--------|------------------------------|----------------------|



735001

| PART # | DESCRIPTION | LINK |
|--------|-------------|------|
|--------|-------------|------|

| | | |
|--------|---------------------------------|----------------------|
| 735001 | Mixer Hydraulic Oil Filter Head | link |
|--------|---------------------------------|----------------------|



735102

| PART # | DESCRIPTION | LINK |
|--------|-------------|------|
|--------|-------------|------|

| | | |
|--------|------------------|----------------------|
| 735102 | Hydraulic Filter | link |
|--------|------------------|----------------------|

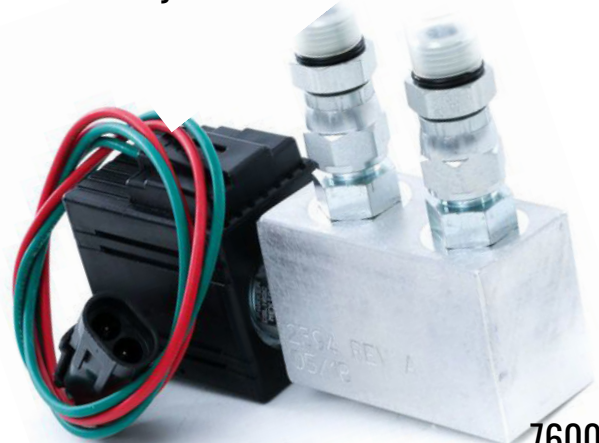

760000

| PART # | DESCRIPTION | LINK |
|--------|-------------|------|
|--------|-------------|------|

| | | |
|--------|-------------------------------|----------------------|
| 760000 | Start/Stop Drum Control Valve | link |
|--------|-------------------------------|----------------------|

CON-TECH HYDRAULIC SYSTEM PARTS

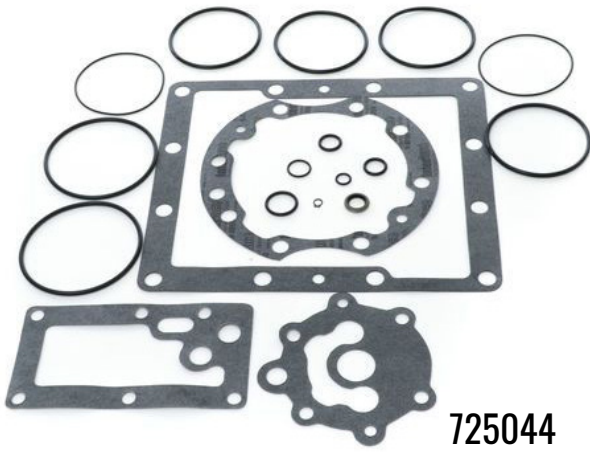

725044

| PART # | DESCRIPTION | LINK |
|--------|------------------------------------|----------------------|
| 725044 | Hydraulic Pump Seal and Gasket Kit | link |



725001

| PART # | DESCRIPTION | LINK |
|--------|---------------------------------------|----------------------|
| 725001 | Shaft Seal Kit for 33-54 Series Pumps | link |



725015

| PART # | DESCRIPTION | LINK |
|--------|-------------------------------|----------------------|
| 725015 | Pump and Motor Shaft Seal Kit | link |



760135

| PART # | DESCRIPTION | LINK |
|--------|---------------------------------|----------------------|
| 760135 | Relief Valve Kit And Motor Plug | link |



799616

| PART # | DESCRIPTION | LINK |
|--------|---|----------------------|
| 799616 | Pump Input Shaft Seal Installation Tool | link |



725000

| PART # | DESCRIPTION | LINK |
|--------|--------------------|----------------------|
| 725000 | Eaton Servo O-Ring | link |

CON-TECH HYDRAULIC SYSTEM PARTS

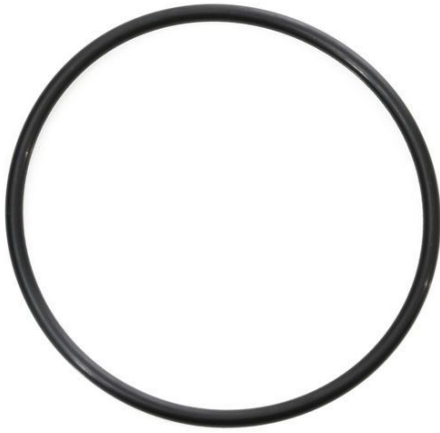

725004



725021

| PART # | DESCRIPTION | LINK |
|--------|-------------------------|----------------------|
| 725004 | Eaton Pump Servo O-Ring | link |

| PART # | DESCRIPTION | LINK |
|--------|--------------------|----------------------|
| 725021 | Parker Pump O-Ring | link |

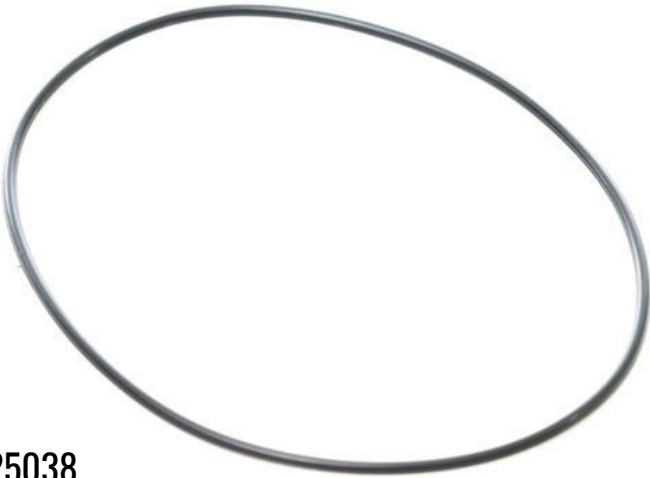

725038

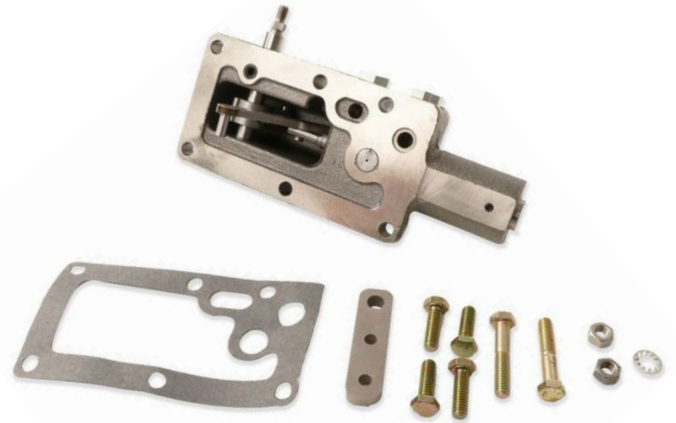

725024

| PART # | DESCRIPTION | LINK |
|--------|--------------------|----------------------|
| 725038 | Charge Pump O-Ring | link |

| PART # | DESCRIPTION | LINK |
|--------|----------------------|----------------------|
| 725024 | Manual Control Valve | link |

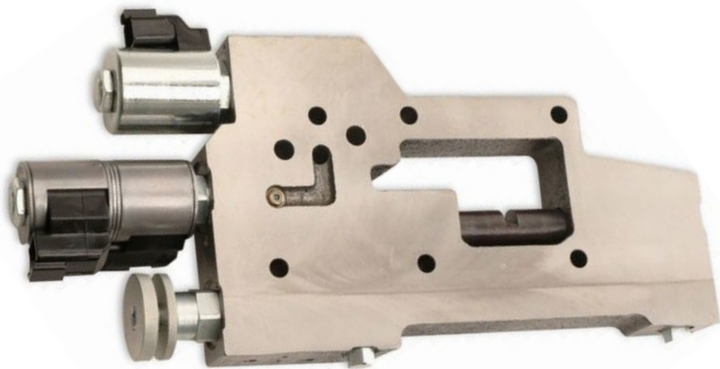

725007



725049

| PART # | DESCRIPTION | LINK |
|--------|----------------------------------|----------------------|
| 725007 | RE Remote Control Valve Assembly | link |

| PART # | DESCRIPTION | LINK |
|--------|--------------|----------------------|
| 725049 | Viton O-Ring | link |

CON-TECH HYDRAULIC SYSTEM PARTS



725026

| PART # | DESCRIPTION | LINK |
|--------|---|----------------------|
| 725026 | Double Link Control Valve - New Aftermarket | link |
| 725027 | Double Link Control Valve RE - Rebuilt | link |

| PART # | DESCRIPTION | LINK |
|--------|-------------------------|----------------------|
| 725037 | RE Control Valve Piston | link |



740036

| PART # | DESCRIPTION | LINK |
|--------|---|----------------------|
| 740036 | Control Cartridges with Coils and Harness | link |



725002

| PART # | DESCRIPTION | LINK |
|--------|--|----------------------|
| 725002 | Gasket Kit for Eaton Manual Control Valves | link |



740005

| PART # | DESCRIPTION | LINK |
|--------|-------------------------------|----------------------|
| 740005 | Eaton RE Control Valve Gasket | link |



740006

| PART # | DESCRIPTION | LINK |
|--------|----------------------|----------------------|
| 740006 | Control Valve Gasket | link |

CON-TECH HYDRAULIC SYSTEM PARTS



725016

| PART # | DESCRIPTION | LINK |
|--------|--------------------|----------------------|
| 725016 | Charge Pump Gasket | link |



725040

| PART # | DESCRIPTION | LINK |
|--------|--------------|----------------------|
| 725040 | A-Pad Gasket | link |



725041

| PART # | DESCRIPTION | LINK |
|--------|--------------------|----------------------|
| 725041 | Compensator Gasket | link |



725022

| PART # | DESCRIPTION | LINK |
|--------|--------------------------|----------------------|
| 725022 | Pump Control Valve Shaft | link |



740043

| PART # | DESCRIPTION | LINK |
|--------|---------------|----------------------|
| 740043 | Solenoid Coil | link |



740040

| PART # | DESCRIPTION | LINK |
|--------|---|----------------------|
| 740040 | Solenoid Coil with Deutsche Connector - 12V | link |



740017

| PART # | DESCRIPTION | LINK |
|--------|-------------|------|
|--------|-------------|------|

| | | |
|--------|--------------------------|----------------------|
| 740017 | Solenoid Valve Cartridge | link |
|--------|--------------------------|----------------------|



740018

| PART # | DESCRIPTION | LINK |
|--------|-------------|------|
|--------|-------------|------|

| | | |
|--------|--|----------------------|
| 740018 | Drum Charge Discharge Solenoid Coil RE Control Valve | link |
|--------|--|----------------------|



740021

| PART # | DESCRIPTION | LINK |
|--------|-------------|------|
|--------|-------------|------|

| | | |
|--------|--------------------------------------|----------------------|
| 740021 | Cartridge and Coil - RE Start / Stop | link |
|--------|--------------------------------------|----------------------|



740019

| PART # | DESCRIPTION | LINK |
|--------|-------------|------|
|--------|-------------|------|

| | | |
|--------|-------------------------|----------------------|
| 740019 | Hydraforce Valve Bypass | link |
|--------|-------------------------|----------------------|

| PART # | DESCRIPTION | LINK |
|--------|-------------|------|
|--------|-------------|------|

745300
 Compensator
 Pump - Right
 Hand with Rear
 Ports

[link](#)



745300



745309

| PART # | DESCRIPTION | LINK |
|--------|-------------|------|
|--------|-------------|------|

745309
 Left Hand
 Compensator
 Pump with
 Rear Ports

[link](#)

CON-TECH HYDRAULIC SYSTEM PARTS

| PART # | DESCRIPTION | LINK |
|--------|-------------|------|
|--------|-------------|------|

745301 Right Hand A Pad Gear Pump [link](#)

| PART # | DESCRIPTION | LINK |
|--------|-------------|------|
|--------|-------------|------|

745451 Eaton 54 Series Hydraulic Motor - 21 Spline w/o HPRV [link](#)



| PART # | DESCRIPTION | LINK |
|--------|-------------|------|
|--------|-------------|------|

745450 Hydraulic Motor Without HPRV [link](#)

| PART # | DESCRIPTION | LINK |
|--------|-------------|------|
|--------|-------------|------|

745452 Hydraulic Motor with 4 Wire Speed Sensor [link](#)



| PART # | DESCRIPTION | LINK |
|--------|-------------|------|
|--------|-------------|------|

745302 Counter Clockwise Hydraulic Gear Pump [link](#)





725017

| PART # | DESCRIPTION | LINK |
|--------|---|----------------------|
| 725017 | 1/16in Thick Plant Fiber Hydraulic Motor Gasket | link |



740029

| PART # | DESCRIPTION | LINK |
|--------|-------------------------|----------------------|
| 740029 | Quadrature Speed Sensor | link |

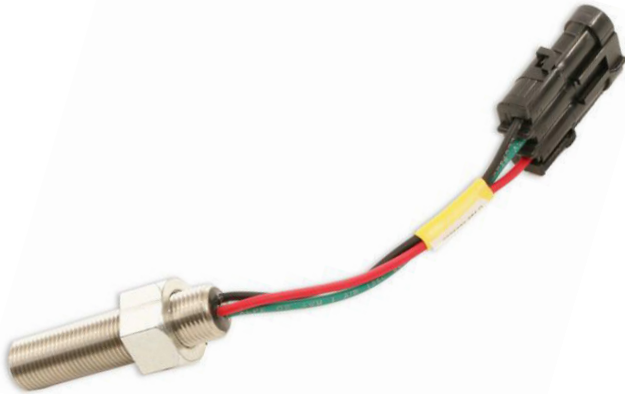

740028

| PART # | DESCRIPTION | LINK |
|--------|----------------------------|----------------------|
| 740028 | Drum Constant Speed Sensor | link |



725018

| PART # | DESCRIPTION | LINK |
|--------|----------------------|----------------------|
| 725018 | High Pressure O-Ring | link |



100107

| PART # | DESCRIPTION | LINK |
|--------|---------------------------------|----------------------|
| 100107 | High Pressure Hose Split Flange | link |



100172

| PART # | DESCRIPTION | LINK |
|--------|-------------------------------|----------------------|
| 100172 | Split Flange 90 Elbow Fitting | link |

CON-TECH HYDRAULIC SYSTEM PARTS



795010



795012

| PART # | DESCRIPTION | LINK |
|--------|-------------|------|
|--------|-------------|------|

795010 1310 Series Flange Yoke [link](#)

| PART # | DESCRIPTION | LINK |
|--------|-------------|------|
|--------|-------------|------|

795012 1310 Series Tapered End Yoke for 1-3/8in Tapered Shaft [link](#)



795013

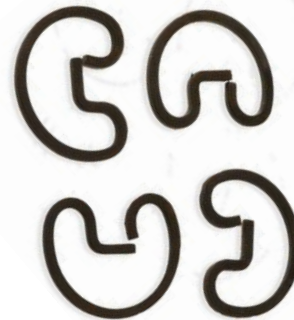

795002



| PART # | DESCRIPTION | LINK |
|--------|-------------|------|
|--------|-------------|------|

795013 1310 Series Tapered End Yoke for 1-1/2in Tapered Shaft [link](#)

| PART # | DESCRIPTION | LINK |
|--------|-------------|------|
|--------|-------------|------|

795002 1310 Series U-Joint [link](#)



795004

| PART # | DESCRIPTION | LINK |
|--------|-------------|------|
|--------|-------------|------|

795004 U-Joint 1310 x 1350 Conversion [link](#)



795019

| PART # | DESCRIPTION | LINK |
|--------|-------------|------|
|--------|-------------|------|

795019 Hydraulic Pump Shaft Nut [link](#)



795000

| PART # | DESCRIPTION | LINK |
|--------|------------------------|----------------------|
| 795000 | 1310 Series U-Bolt Kit | link |



795005

| PART # | DESCRIPTION | LINK |
|--------|------------------------------|----------------------|
| 795005 | 1350 Series U-Joint Bolt Kit | link |



795003

| PART # | DESCRIPTION | LINK |
|--------|------------------------|----------------------|
| 795003 | Universal Joint - 1350 | link |



795001

| PART # | DESCRIPTION | LINK |
|--------|---------------------|----------------------|
| 795001 | 1350 Series U-Joint | link |



795006

| PART # | DESCRIPTION | LINK |
|--------|--|----------------------|
| 795006 | PTO End Yoke 1350 Strap Bolt Style for 1-1/2in Tapered Shaft | link |



750050

| PART # | DESCRIPTION | LINK |
|--------|---------------------|----------------------|
| 750050 | BridgeKing Cylinder | link |

CON-TECH HYDRAULIC SYSTEM PARTS



750011

| PART # | DESCRIPTION | LINK |
|--------|---|----------------------|
| 750011 | BMV Hydraulic Cylinder Rebuild Exchange | link |



750012

| PART # | DESCRIPTION | LINK |
|--------|---|----------------------|
| 750012 | 4.5in x 4.5in x 31.88in Bridgemaster Cylinder | link |



750051

| PART # | DESCRIPTION | LINK |
|--------|--------------------------------|----------------------|
| 750051 | Booster Pivot Urethane Bushing | link |



730150

| PART # | DESCRIPTION | LINK |
|--------|----------------------------------|----------------------|
| 730150 | Bridgemaster Cylinder Seal Saver | link |



750000

| PART # | DESCRIPTION | LINK |
|--------|------------------------------------|----------------------|
| 750000 | Hydraulic Cylinder - Single Acting | link |



750001

| PART # | DESCRIPTION | LINK |
|--------|---|----------------------|
| 750001 | Mixer Double Acting Chute Lift Cylinder | link |

CON-TECH HYDRAULIC SYSTEM PARTS

| PART # | DESCRIPTION | LINK |
|--------|-------------|------|
|--------|-------------|------|

750060 BridgeKing Lock Latch Cylinder [link](#)

| PART # | DESCRIPTION | LINK |
|--------|-------------|------|
|--------|-------------|------|

104050 Main Chute Cylinder Hose Kit [link](#)



750004

| PART # | DESCRIPTION | LINK |
|--------|-------------|------|
|--------|-------------|------|

750004 Cylinder Latch Assembly [link](#)



750020



750017

| PART # | DESCRIPTION | LINK |
|--------|-------------|------|
|--------|-------------|------|

750020 Hyd Drum Control Cylinder [link](#)

| PART # | DESCRIPTION | LINK |
|--------|-------------|------|
|--------|-------------|------|

750017 Hydro Chute Cylinder [link](#)



720014



775010

| PART # | DESCRIPTION | LINK |
|--------|-------------|------|
|--------|-------------|------|

720014 BMV Trailer Cylinder Bushing [link](#)

| PART # | DESCRIPTION | LINK |
|--------|-------------|------|
|--------|-------------|------|

775010 Axle Control Arm Pivot Pin [link](#)

CON-TECH HYDRAULIC SYSTEM PARTS



775011

| PART # | DESCRIPTION | LINK |
|--------|-----------------------------------|----------------------|
| 775011 | Axle Control Arm Pivot Pin 7-5/16 | link |



720032

| PART # | DESCRIPTION | LINK |
|--------|--------------------------------|----------------------|
| 720032 | Bridgemaster V Cylinder Washer | link |



720093

| PART # | DESCRIPTION | LINK |
|--------|---|----------------------|
| 720093 | Bridgemaster V Axle Cylinder Pivot Lug 1.50in Block | link |



720094

| PART # | DESCRIPTION | LINK |
|--------|-------------------------------------|----------------------|
| 720094 | Bridgemaster V Cylinder Pivot Block | link |



720002

| PART # | DESCRIPTION | LINK |
|--------|-----------------------------------|----------------------|
| 720002 | 2in Booster Cylinder Ball Bushing | link |



720008

| PART # | DESCRIPTION | LINK |
|--------|--|----------------------|
| 720008 | Booster Cylinder Ball Bushing-2.25 inch ID | link |



705200



725036

| PART # | DESCRIPTION | LINK |
|--------|--|----------------------|
| 705200 | Trailer Cylinder Thumb Pin - 2.25 Inch | link |
| 705201 | Trailer Cylinder Thumb Pin - 2 Inch | link |

| PART # | DESCRIPTION | LINK |
|--------|--|----------------------|
| 725036 | Trailer Axle Cylinder Accumulator Charge Valve | link |



750005

| PART # | DESCRIPTION | LINK |
|--------|--------------------------------------|----------------------|
| 750005 | Axle Cylinder Accumulator Charge Kit | link |



710024

| PART # | DESCRIPTION | LINK |
|--------|--|----------------------|
| 710024 | MJ x MB 90 Degree Fitting for Chute Cylinder | link |

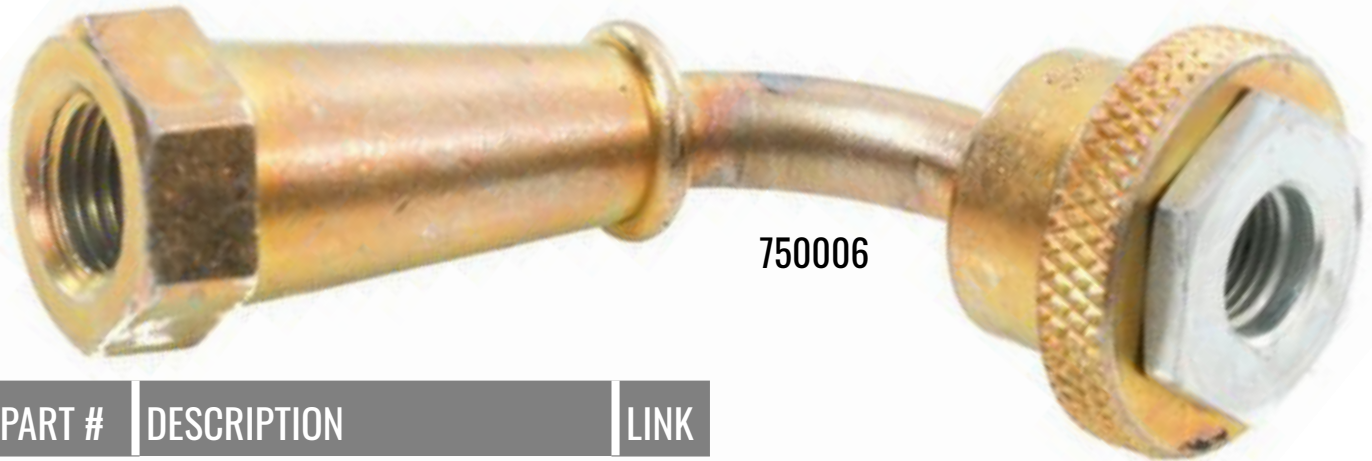

750006

| PART # | DESCRIPTION | LINK |
|--------|---|----------------------|
| 750006 | Trailer Axle Cylinder Accumulator Charge Swivel Fitting | link |

HOUSBY HYDRAULIC SYSTEM PARTS



H12882

| PART # | DESCRIPTION | LINK |
|--------|--------------------------|----------------------|
| H12882 | Hydraulic Oil Cooler Fan | link |

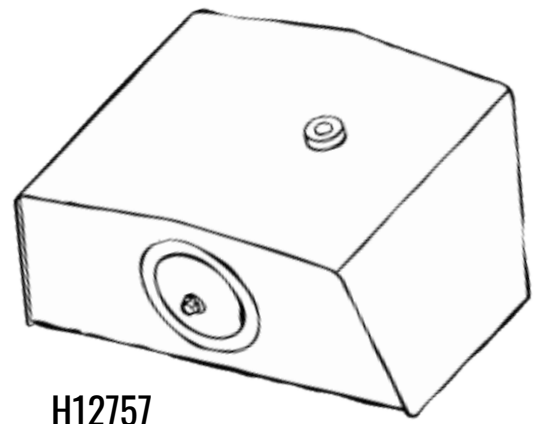

H12757

| PART # | DESCRIPTION | LINK |
|--------|-----------------------|----------------------|
| H12757 | Hydraulic Tank For F3 | link |



H1738

| PART # | DESCRIPTION | LINK |
|--------|------------------------------------|----------------------|
| H1738 | Tank Top Hydraulic Filter Assembly | link |



12758C4

| PART # | DESCRIPTION | LINK |
|---------|--------------------------------------|----------------------|
| 12758C4 | Hydraulic Reservoir Breather Cap Kit | link |



H11799

| PART # | DESCRIPTION | LINK |
|--------|-------------|----------------------|
| H11799 | O-Ring | link |

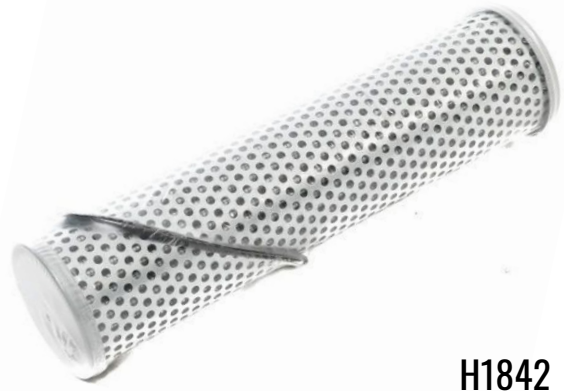

H1842

| PART # | DESCRIPTION | LINK |
|--------|--------------------------------------|----------------------|
| H1842 | Hydraulic Tank Return Filter Element | link |

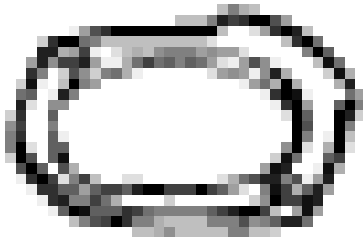

H11810



7774C2

| PART # | DESCRIPTION | LINK |
|--------|------------------------------|----------------------|
| H11810 | Hydraulic Filter Tank Gasket | link |

| PART # | DESCRIPTION | LINK |
|--------|--------------------------------|----------------------|
| 7774C2 | Hydraulic Tank Filter Seal Kit | link |



2758

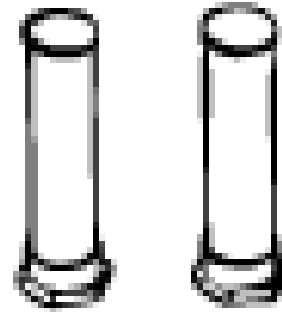

3077

| PART # | DESCRIPTION | LINK |
|--------|-----------------------|----------------------|
| 2758 | Hydraulic Sight Gauge | link |

| PART # | DESCRIPTION | LINK |
|--------|--------------------------------|----------------------|
| 3077 | Hydraulic Tank Strainer Filter | link |



6424

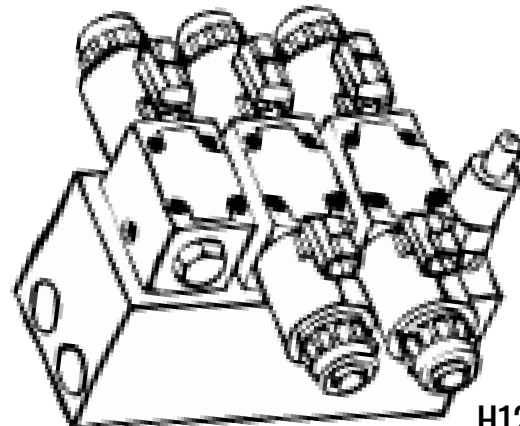

H12338

| PART # | DESCRIPTION | LINK |
|--------|----------------------|----------------------|
| 6424 | 8in Clean-Out Gasket | link |

| PART # | DESCRIPTION | LINK |
|--------|-------------------------------|----------------------|
| H12338 | Front Manifold Valve Assembly | link |

HOUSBY HYDRAULIC SYSTEM PARTS

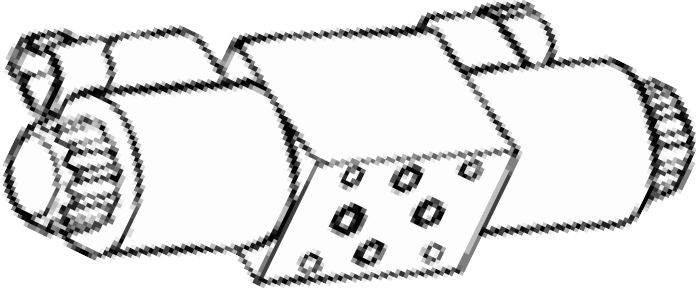

H12535

| PART # | DESCRIPTION | LINK |
|--------|----------------|----------------------|
| H12535 | Solenoid Valve | link |

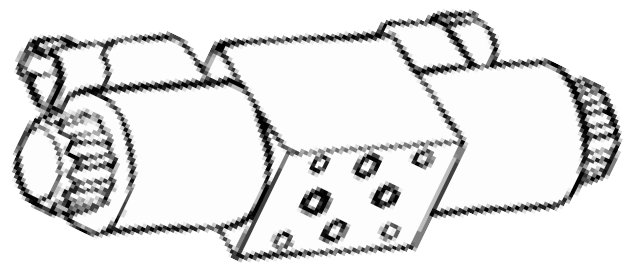

H12536

| PART # | DESCRIPTION | LINK |
|--------|----------------|----------------------|
| H12536 | Solenoid Valve | link |

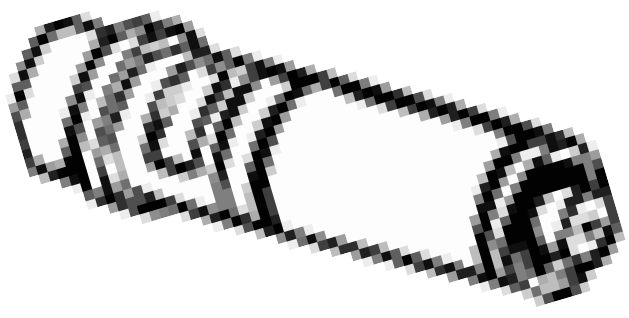

H12599

| PART # | DESCRIPTION | LINK |
|--------|-------------------------------------|----------------------|
| H12599 | D03 Valve Replacement Solenoid Tube | link |

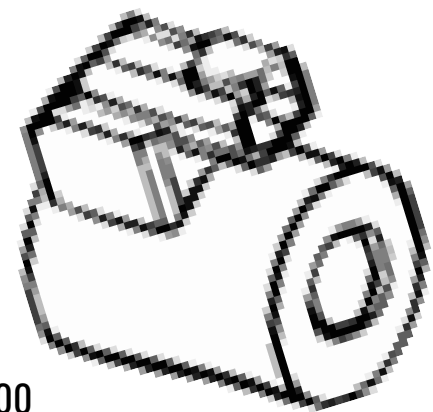

H12600

| PART # | DESCRIPTION | LINK |
|--------|-------------------------------------|----------------------|
| H12600 | D03 Valve Replacement Solenoid Coil | link |

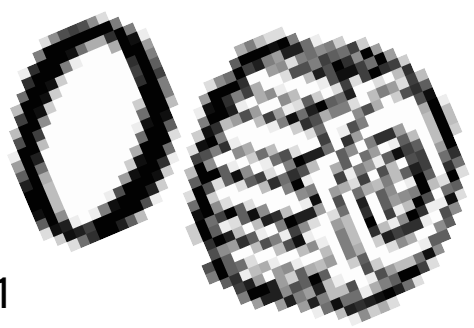

H12601

| PART # | DESCRIPTION | LINK |
|--------|---|----------------------|
| H12601 | D03 Valve Replacement Solenoid Cap and O-Ring | link |

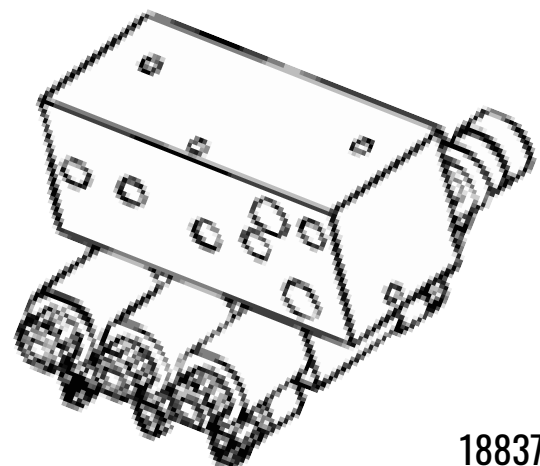

18837

| PART # | DESCRIPTION | LINK |
|--------|-------------------------------|----------------------|
| 18837 | Front Manifold Valve Assembly | link |



21171

| PART # | DESCRIPTION | LINK |
|--------|---|----------------------|
| 21171 | Booster Cylinder Hydraulic Pressure Gauge 2.5in | link |

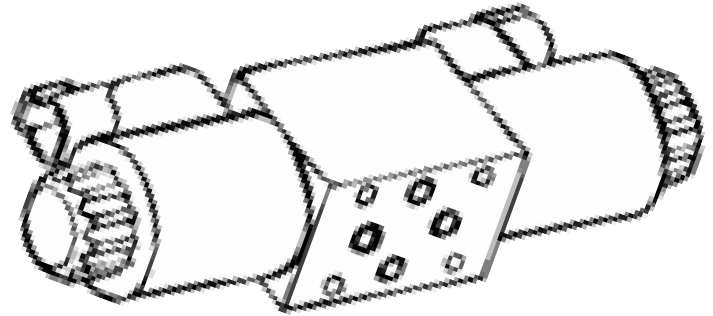

21172

| PART # | DESCRIPTION | LINK |
|--------|------------------------------|----------------------|
| 21172 | D03 Solenoid Valve For 18837 | link |

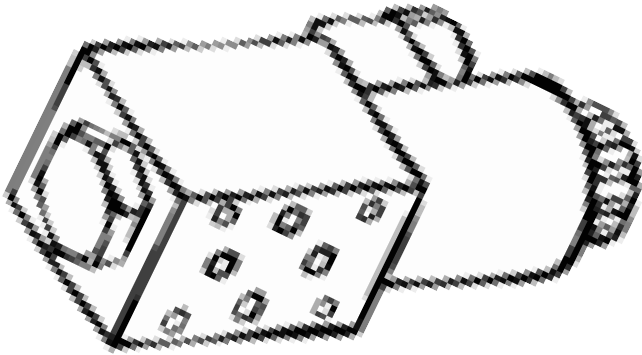

21173

| PART # | DESCRIPTION | LINK |
|--------|----------------|----------------------|
| 21173 | Solenoid Valve | link |



21175

| PART # | DESCRIPTION | LINK |
|--------|--|----------------------|
| 21175 | Bridge Axle Pressure Reducing Valve Assembly | link |

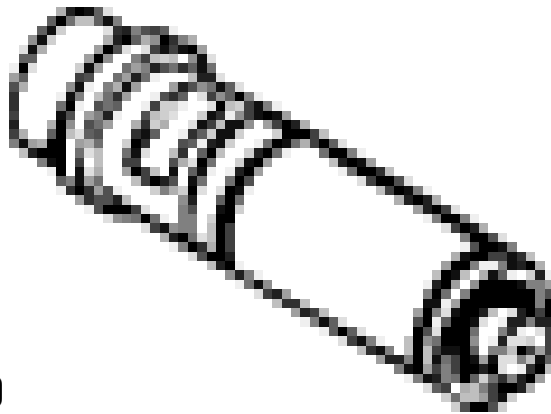

21180

| PART # | DESCRIPTION | LINK |
|--------|--|----------------------|
| 21180 | D03 Valve Replacement Solenoid Cartridge | link |

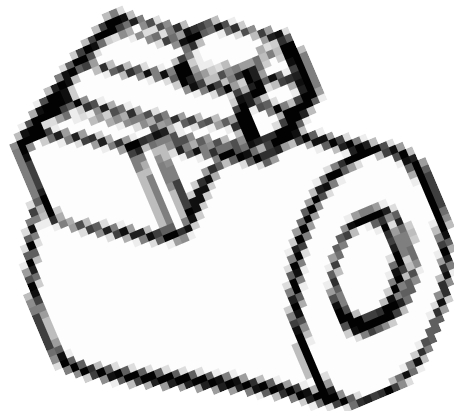

21181

| PART # | DESCRIPTION | LINK |
|--------|-------------------------------------|----------------------|
| 21181 | D03 Valve Replacement Solenoid Coil | link |

HOUSBY HYDRAULIC SYSTEM PARTS

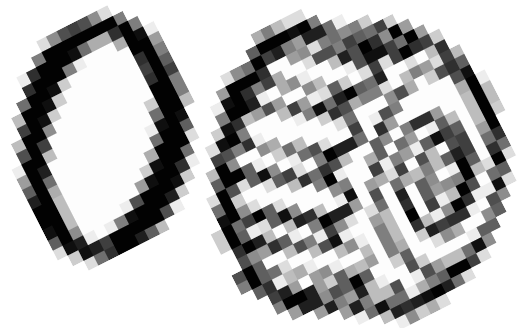

21182

| PART # | DESCRIPTION | LINK |
|--------|---|----------------------|
| 21182 | D03 Valve Replacement Solenoid Cap and O-Ring | link |



7090

| PART # | DESCRIPTION | LINK |
|--------|---------------------------------|----------------------|
| 7090 | High Pressure Hose Split Flange | link |



18791

| PART # | DESCRIPTION | LINK |
|--------|-------------------------------|----------------------|
| 18791 | Split Flange 90 Elbow Fitting | link |

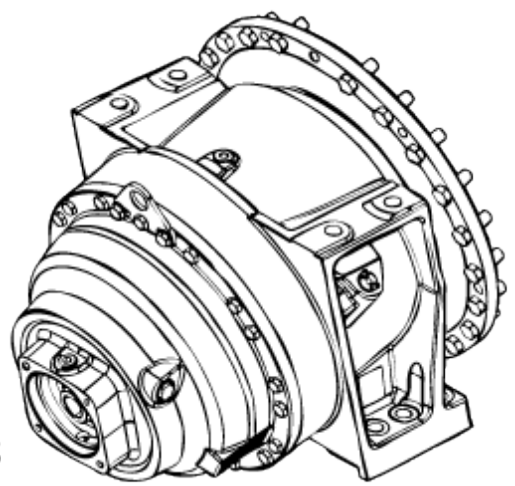

18848

| PART # | DESCRIPTION | LINK |
|--------|------------------------------|----------------------|
| 18848 | New Mixer Drum Drive Gearbox | link |



21169

| PART # | DESCRIPTION | LINK |
|--------|------------------------|----------------------|
| 21169 | Hydraulic Motor Gasket | link |



27178

| PART # | DESCRIPTION | LINK |
|--------|----------------------------------|----------------------|
| 27178 | Hydraulic Motor With Sensor Port | link |

HOUSBY HYDRAULIC SYSTEM PARTS



21170



21196

| PART # | DESCRIPTION | LINK |
|--------|------------------------|----------------------|
| 21170 | Hydraulic Speed Sensor | link |

| PART # | DESCRIPTION | LINK |
|--------|-------------|----------------------|
| 21196 | Slump Gauge | link |

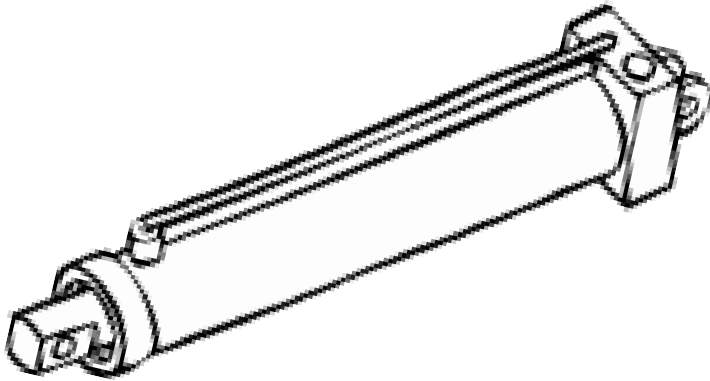

19070



18693

| PART # | DESCRIPTION | LINK |
|--------|---------------------|----------------------|
| 19070 | Chute Lift Cylinder | link |

| PART # | DESCRIPTION | LINK |
|--------|---------------------|----------------------|
| 18693 | Chute Lock Cylinder | link |



18759



19347

| PART # | DESCRIPTION | LINK |
|--------|----------------------|----------------------|
| 18759 | Chute Lock Grip Bolt | link |

| PART # | DESCRIPTION | LINK |
|--------|-------------------|----------------------|
| 19347 | Chute Lock Spacer | link |

HOUSBY HYDRAULIC SYSTEM PARTS

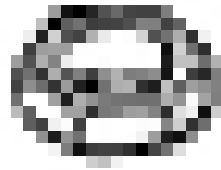

70901431

| PART # | DESCRIPTION | LINK |
|----------|---------------------------|----------------------|
| 70901431 | Chute Lock Jam Nut .75-10 | link |



21162

| PART # | DESCRIPTION | LINK |
|--------|--------------|----------------------|
| 21162 | B-Pad Gasket | link |



21161

| PART # | DESCRIPTION | LINK |
|--------|---------------------------|----------------------|
| 21161 | B-Pad Hydraulic Pony Pump | link |



H11371

| PART # | DESCRIPTION | LINK |
|--------|---------------------------|----------------------|
| H11371 | B-Pad Hydraulic Pony Pump | link |

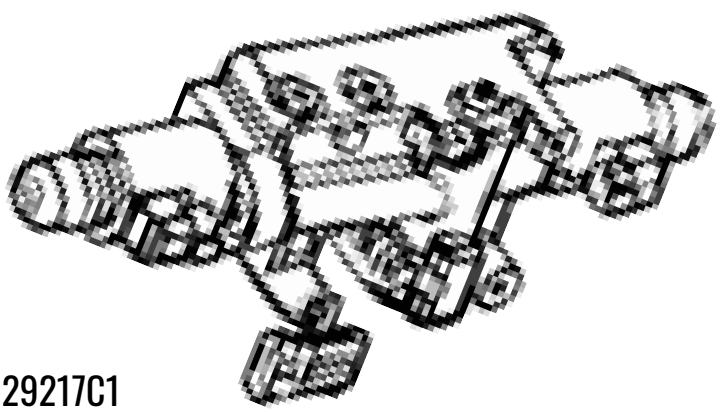

29217C1

| PART # | DESCRIPTION | LINK |
|---------|---------------|----------------------|
| 29217C1 | PTO Pump Coil | link |

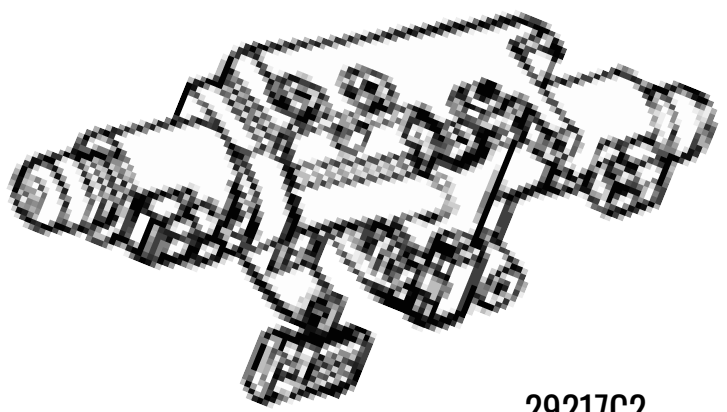

29217C2

| PART # | DESCRIPTION | LINK |
|---------|---------------|----------------------|
| 29217C2 | PTO Pump Stem | link |

HOUSBY HYDRAULIC SYSTEM PARTS



H11687



21161EX

| PART # | DESCRIPTION | LINK |
|--------|-------------|------|
|--------|-------------|------|

H11687 6in Short Charge Pump Pressure Hydraulic Filter Element [link](#)

| PART # | DESCRIPTION | LINK |
|--------|-------------|------|
|--------|-------------|------|

21161EX Rebuilt B-Pad Hydraulic Pony Pump [link](#)



H12024

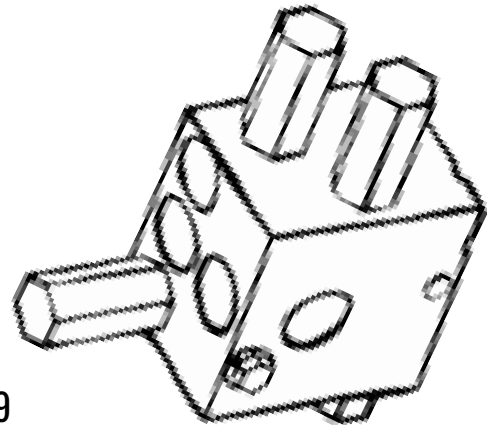

18839

| PART # | DESCRIPTION | LINK |
|--------|-------------|------|
|--------|-------------|------|

H12024 Charge Pump Gasket A-Pad [link](#)

| PART # | DESCRIPTION | LINK |
|--------|-------------|------|
|--------|-------------|------|

18839 Bridge Axle Valve Manifold [link](#)

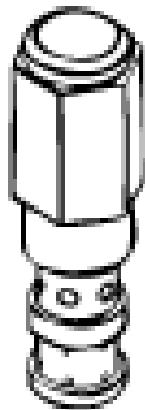

21190



21191

| PART # | DESCRIPTION | LINK |
|--------|-------------|------|
|--------|-------------|------|

21190 Pressure Reducing Valve [link](#)

| PART # | DESCRIPTION | LINK |
|--------|-------------|------|
|--------|-------------|------|

21191 Relief Valve [link](#)

HOUSBY HYDRAULIC SYSTEM PARTS

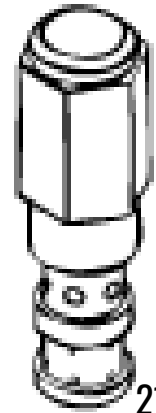

21192

| PART # | DESCRIPTION | LINK |
|--------|--------------|----------------------|
| 21192 | Relief Valve | link |

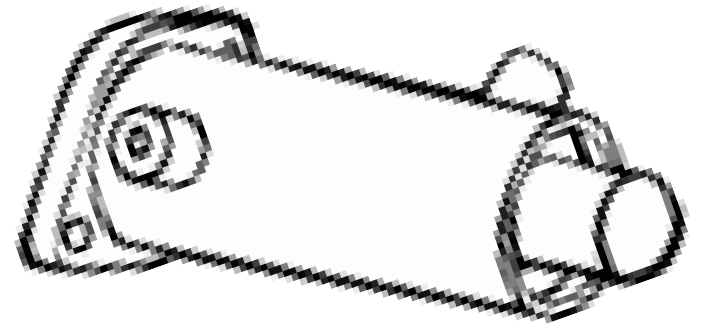

H10111

| PART # | DESCRIPTION | LINK |
|--------|--------------------|----------------------|
| H10111 | Axle Lock Cylinder | link |



H11701

| PART # | DESCRIPTION | LINK |
|--------|----------------------|----------------------|
| H11701 | Bridge Axle Lock Pin | link |

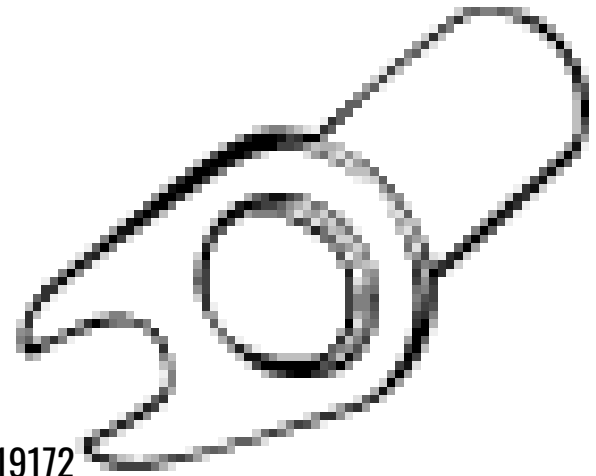

19172

| PART # | DESCRIPTION | LINK |
|--------|----------------------|----------------------|
| 19172 | Bridge Axle Lock Pin | link |

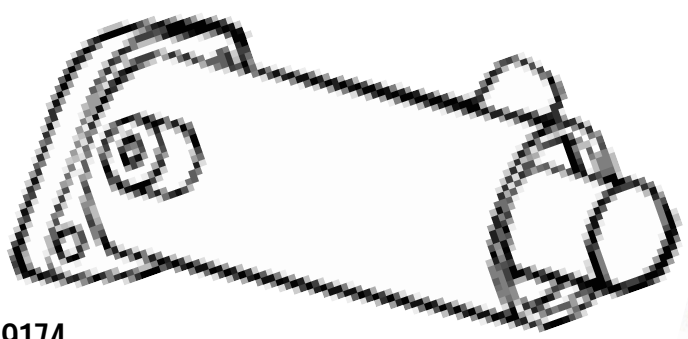

19174

| PART # | DESCRIPTION | LINK |
|--------|---------------------------|----------------------|
| 19174 | Bridge Axle Lock Cylinder | link |



19048

| PART # | DESCRIPTION | LINK |
|--------|------------------------------|----------------------|
| 19048 | Bridge Axle Booster Cylinder | link |



19048EX



H2143

| PART # | DESCRIPTION | LINK |
|--------|-------------|------|
|--------|-------------|------|

19048EX Bridge Axle Booster Cylinder [link](#)

| PART # | DESCRIPTION | LINK |
|--------|-------------|------|
|--------|-------------|------|

H2143 Booster Cylinder Ball Bushing - 2.25in [link](#)



34321



H901001200

| PART # | DESCRIPTION | LINK |
|--------|-------------|------|
|--------|-------------|------|

34321 Bridgmaster Cylinder Mount Clamp Kit [link](#)

| PART # | DESCRIPTION | LINK |
|--------|-------------|------|
|--------|-------------|------|

H901001200 Hydraulic Spin On Oil Filter [link](#)



H901002600



H321010000

| PART # | DESCRIPTION | LINK |
|--------|-------------|------|
|--------|-------------|------|

H901002600 Hydraulic HP Filter Element 15P Element [link](#)

| PART # | DESCRIPTION | LINK |
|--------|-------------|------|
|--------|-------------|------|

H321010000 Quadrature Speed Sensor [link](#)

KIMBLE HYDRAULIC SYSTEM PARTS

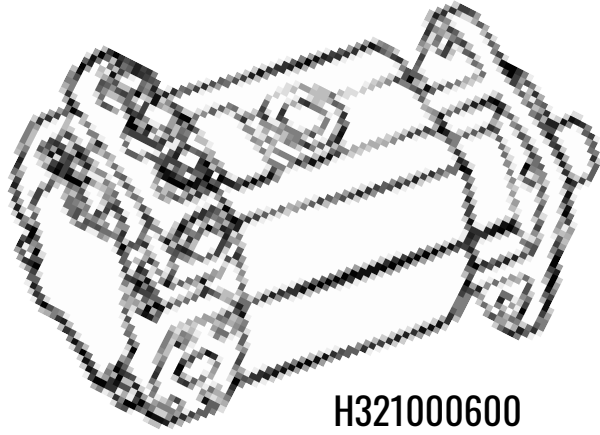

H321000600

| PART # | DESCRIPTION | LINK |
|------------|--|----------------------|
| H321000600 | Hydraulic Motor with 4 Wire Speed Sensor | link |

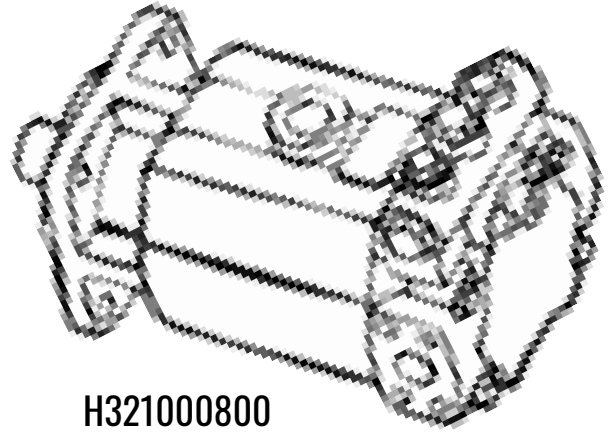

H321000800

| PART # | DESCRIPTION | LINK |
|------------|--------------------|----------------------|
| H321000800 | Speed Sensor Motor | link |

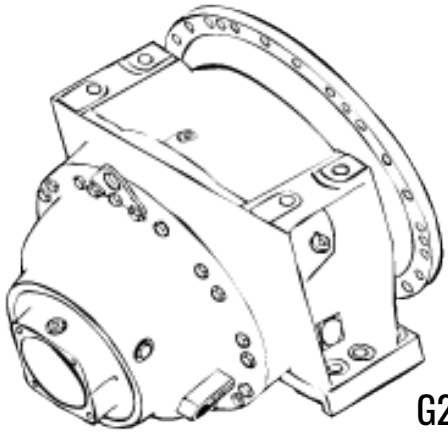

G210410800

| PART # | DESCRIPTION | LINK |
|------------|------------------------------|----------------------|
| G210410800 | New Mixer Drum Drive Gearbox | link |



H311010158

| PART # | DESCRIPTION | LINK |
|------------|------------------------|----------------------|
| H311010158 | Hydraulic Motor Gasket | link |



H62F161600

| PART # | DESCRIPTION | LINK |
|------------|----------------------------|----------------------|
| H62F161600 | Split Flange Elbow Fitting | link |



200030901

| PART # | DESCRIPTION | LINK |
|-----------|---------------------------------|----------------------|
| 200030901 | High Pressure Hose Split Flange | link |

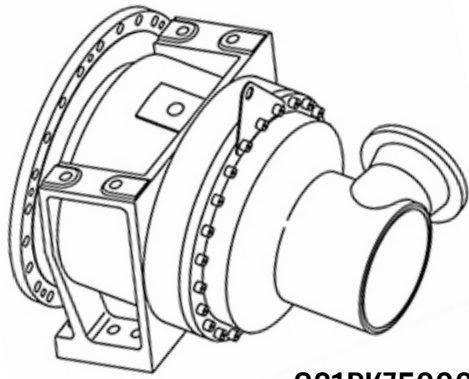

G21PK75000

| PART # | DESCRIPTION | LINK |
|------------|------------------------------|----------------------|
| G21PK75000 | New Mixer Drum Drive Gearbox | link |

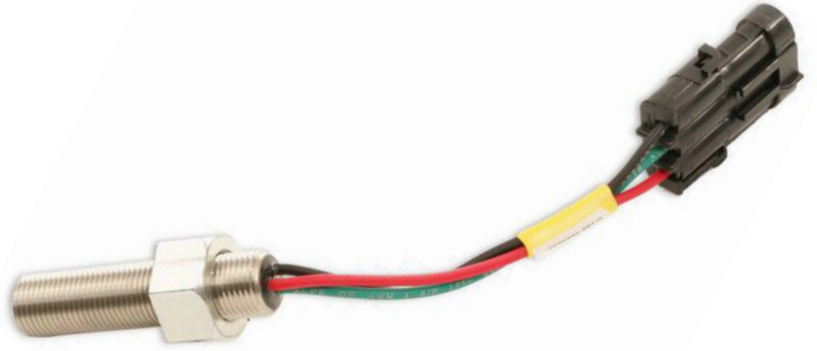

H321020000

| PART # | DESCRIPTION | LINK |
|------------|----------------------------|----------------------|
| H321020000 | Drum Constant Speed Sensor | link |



C951030000

| PART # | DESCRIPTION | LINK |
|------------|--|----------------------|
| C951030000 | Plastic Hydraulic ZT Gearbox Oil Sight Gauge | link |



H802026030

| PART # | DESCRIPTION | LINK |
|------------|---|----------------------|
| H802026030 | RE Mixer Control Valve Charge Discharge Solenoid Coil | link |



H1110937901

| PART # | DESCRIPTION | LINK |
|-------------|----------------------------|----------------------|
| H1110937901 | RE Control Valve Cartridge | link |



H802015670

| PART # | DESCRIPTION | LINK |
|------------|---------------|----------------------|
| H802015670 | Solenoid Coil | link |

KIMBLE HYDRAULIC SYSTEM PARTS

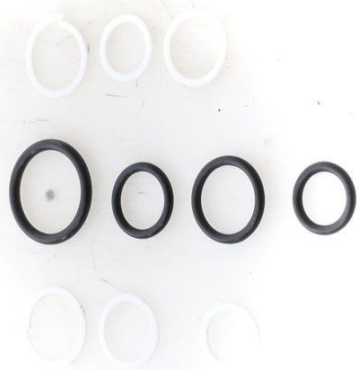

H112026030SK



H312000300

| PART # | DESCRIPTION | LINK |
|--------------|--------------------------|----------------------|
| H112026030SK | Valve Cartridge Seal Kit | link |

| PART # | DESCRIPTION | LINK |
|------------|---|----------------------|
| H312000300 | RE Remote Control Valve for Eaton Pumps | link |

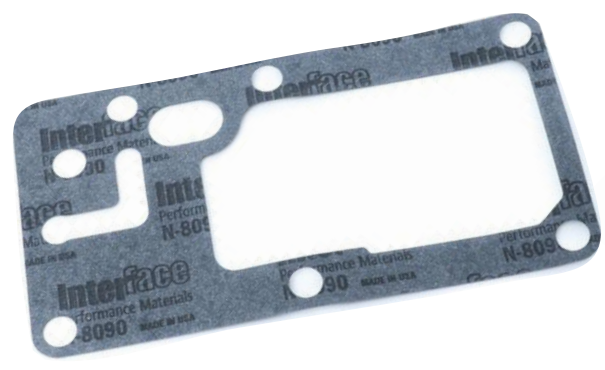

H321102130



H311000123

| PART # | DESCRIPTION | LINK |
|------------|------------------------------|----------------------|
| H321102130 | Pump RE Control Valve Gasket | link |

| PART # | DESCRIPTION | LINK |
|------------|-------------------------------|----------------------|
| H311000123 | New Double Link Control Valve | link |



H311010159



H311010301

| PART # | DESCRIPTION | LINK |
|------------|-------------|----------------------|
| H311010159 | O-Ring | link |

| PART # | DESCRIPTION | LINK |
|------------|---|----------------------|
| H311010301 | Booster Axle Compensator Pump RH Rotation | link |



H311010100

| PART # | DESCRIPTION | LINK |
|------------|---------------------------------|----------------------|
| H311010100 | Pressure Compensator Chute Pump | link |



H311010200

| PART # | DESCRIPTION | LINK |
|------------|---------------------------------|----------------------|
| H311010200 | Pressure Compensator Chute Pump | link |



802026030ALT

| PART # | DESCRIPTION | LINK |
|--------------|---|----------------------|
| 802026030ALT | Drum Charge Discharge Solenoid Coil Alternate | link |



900003597

| PART # | DESCRIPTION | LINK |
|-----------|-------------------|----------------------|
| 900003597 | Directional Valve | link |



H102560000

| PART # | DESCRIPTION | LINK |
|------------|----------------------|----------------------|
| H102560000 | Chute Block Assembly | link |

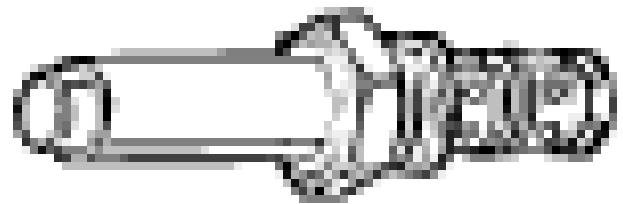

H112560001

| PART # | DESCRIPTION | LINK |
|------------|-------------------------------|----------------------|
| H112560001 | Chute Trailer Valve Cartridge | link |

KIMBLE HYDRAULIC SYSTEM PARTS



H802560001

| PART # | DESCRIPTION | LINK |
|------------|-------------------|----------------------|
| H802560001 | 12V Solenoid Coil | link |



H123400100

| PART # | DESCRIPTION | LINK |
|------------|-------------------------|----------------------|
| H123400100 | Pressure Reducing Valve | link |



H122157000

| PART # | DESCRIPTION | LINK |
|------------|-----------------------------------|----------------------|
| H122157000 | Hydraulic Pressure Reducing Valve | link |



H112250000

| PART # | DESCRIPTION | LINK |
|------------|-----------------------|----------------------|
| H112250000 | Idler Valve Cartridge | link |

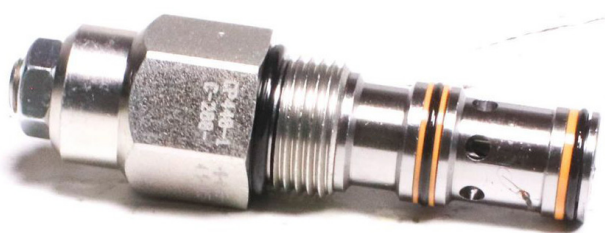

H123400200

| PART # | DESCRIPTION | LINK |
|------------|---------------------------|----------------------|
| H123400200 | Pressure Regulating Valve | link |



H122152400

| PART # | DESCRIPTION | LINK |
|------------|----------------------|----------------------|
| H122152400 | Latch Sequence Valve | link |



H123124400

| PART # | DESCRIPTION | LINK |
|--------|-------------|------|
|--------|-------------|------|

H123124400 Counter Balance Valve [link](#)



H112560002

| PART # | DESCRIPTION | LINK |
|--------|-------------|------|
|--------|-------------|------|

H112560002 Chute Brake Valve Cartridge [link](#)

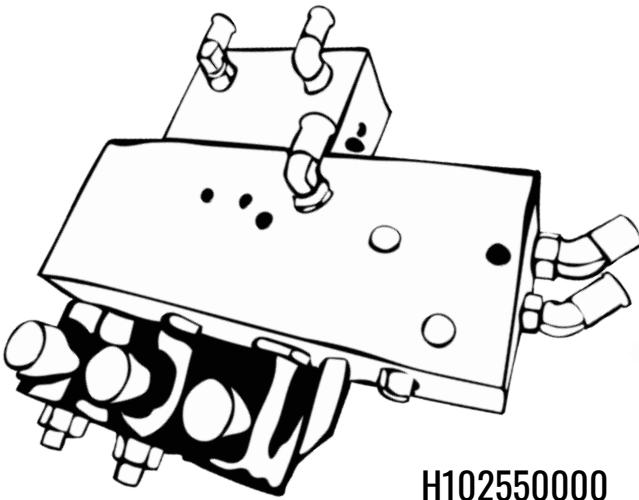

H102550000

| PART # | DESCRIPTION | LINK |
|--------|-------------|------|
|--------|-------------|------|

H102550000 Chute Block Manifold Assembly [link](#)



H112391200

| PART # | DESCRIPTION | LINK |
|--------|-------------|------|
|--------|-------------|------|

H112391200 Solenoid Cartridge Valve [link](#)



H802152100

| PART # | DESCRIPTION | LINK |
|--------|-------------|------|
|--------|-------------|------|

H802152100 Chute Lock-Chute Lift Coil [link](#)

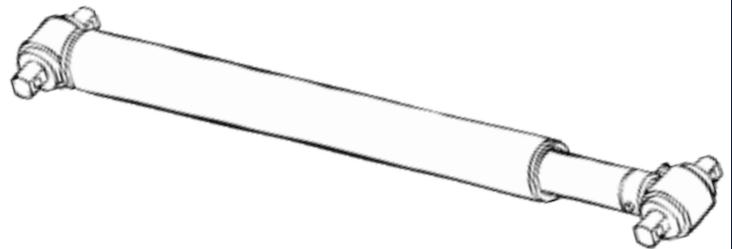

H411001000

| PART # | DESCRIPTION | LINK |
|--------|-------------|------|
|--------|-------------|------|

H411001000 Rebuilt Hydraulic Cylinder Booster [link](#)

KIMBLE HYDRAULIC SYSTEM PARTS

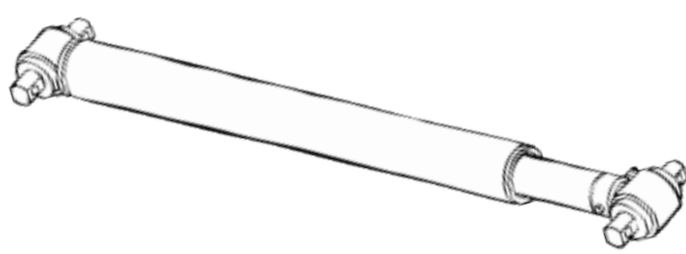

H411001301

| PART # | DESCRIPTION | LINK |
|------------|------------------------------------|----------------------|
| H411001301 | Rebuilt Hydraulic Cylinder Booster | link |



H521000102

| PART # | DESCRIPTION | LINK |
|------------|--------------------------------------|----------------------|
| H521000102 | .25in Steel Hydraulic Line - Trailer | link |



H411001209

| PART # | DESCRIPTION | LINK |
|------------|---|----------------------|
| H411001209 | Trailer Axle Cylinder Flow Control Valve Assembly | link |

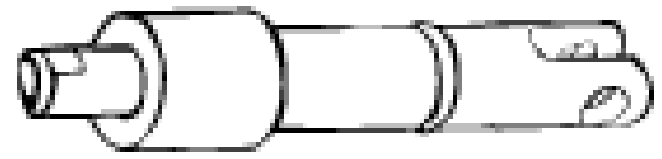

H411011000

| PART # | DESCRIPTION | LINK |
|------------|------------------------|----------------------|
| H411011000 | Trailer Latch Cylinder | link |



H421001200

| PART # | DESCRIPTION | LINK |
|------------|---------------------------|----------------------|
| H421001200 | Mixer Chute Lift Cylinder | link |



H422002200

| PART # | DESCRIPTION | LINK |
|------------|----------------------|----------------------|
| H422002200 | Chute Brake Cylinder | link |

KIMBLE HYDRAULIC SYSTEM PARTS



H422001000

| PART # | DESCRIPTION | LINK |
|------------|-------------------------------|----------------------|
| H422001000 | Hydraulic Chute Lock Assembly | link |



H431001000

| PART # | DESCRIPTION | LINK |
|------------|--------------------------------------|----------------------|
| H431001000 | Hydraulic Hopper Lift Cylinder Small | link |



H431001001

| PART # | DESCRIPTION | LINK |
|------------|---|----------------------|
| H431001001 | Charge Hopper Cylinder Seal and Packing Kit | link |



H521015102

| PART # | DESCRIPTION | LINK |
|------------|----------------------|----------------------|
| H521015102 | Hydraulic Hose -20in | link |



H521010303

| PART # | DESCRIPTION | LINK |
|------------|-----------------------|----------------------|
| H521010303 | Hydraulic Hose - 51in | link |



H521000101

| PART # | DESCRIPTION | LINK |
|------------|------------------------------------|----------------------|
| H521000101 | .25in Steel Hydraulic Line - Slump | link |

LONDON HYDRAULIC SYSTEM PARTS



MB38576

| PART # | DESCRIPTION | LINK |
|---------|--|----------------------|
| MB38576 | Hydraulic Chute Cylinder - Double Acting | link |



MA39790

| PART # | DESCRIPTION | LINK |
|---------|-----------------------------------|----------------------|
| MA39790 | Hydraulic Solenoid Valve Assembly | link |

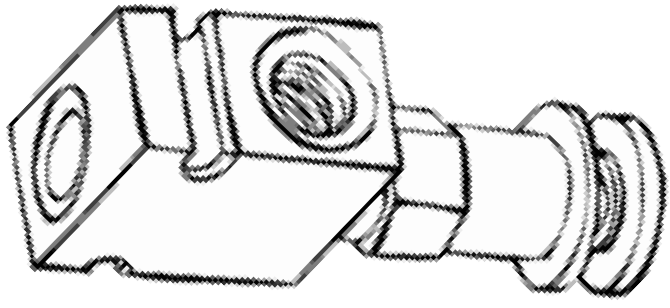

MA39231

| PART # | DESCRIPTION | LINK |
|---------|-----------------------------------|----------------------|
| MA39231 | Hydraulic Pressure Reducing Valve | link |

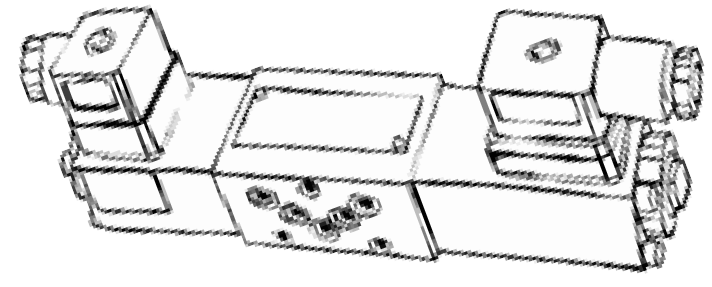

MB4077901

| PART # | DESCRIPTION | LINK |
|-----------|----------------|----------------------|
| MB4077901 | Solenoid Valve | link |



MA35899

| PART # | DESCRIPTION | LINK |
|---------|-----------------------------|----------------------|
| MA35899 | Double Acting Control Valve | link |



MA3173701

| PART # | DESCRIPTION | LINK |
|-----------|-------------|----------------------|
| MA3173701 | Gear Pump | link |



1270164

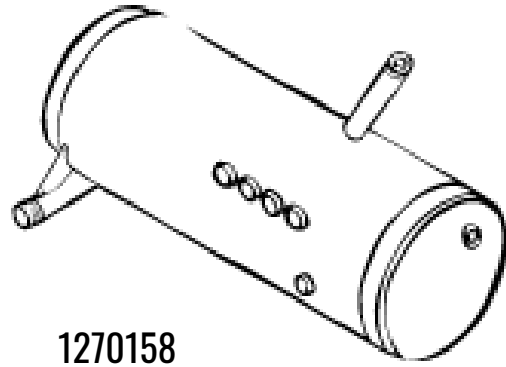

1270158

| PART # | DESCRIPTION | LINK |
|---------|-----------------------------------|----------------------|
| 1270164 | Hyd Oil Tank- 23 Gallon Reservoir | link |

| PART # | DESCRIPTION | LINK |
|---------|------------------------------------|----------------------|
| 1270158 | 13 Gallon Oil Reservoir with Mount | link |

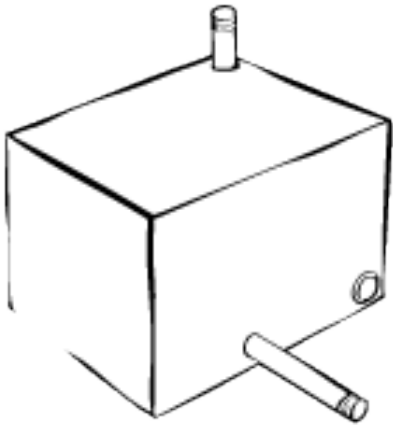

0150870



1146363

| PART # | DESCRIPTION | LINK |
|---------|-------------------------------------|----------------------|
| 0150870 | Square Hydraulic Oil Tank Reservoir | link |

| PART # | DESCRIPTION | LINK |
|---------|---|----------------------|
| 1146363 | Bridgemaster Latch Hook Cylinder 2x1.25x2 | link |



1139838



1139840

| PART # | DESCRIPTION | LINK |
|---------|-----------------------------------|----------------------|
| 1139838 | Double Acting Chute Lift Cylinder | link |

| PART # | DESCRIPTION | LINK |
|---------|--|----------------------|
| 1139840 | Hydraulic Cylinder - Single Acting 7/8 | link |

MCNEILUS HYDRAULIC SYSTEM PARTS



0082322

| PART # | DESCRIPTION | LINK |
|---------|----------------------------|----------------------|
| 0082322 | Power Chute Cylinder Small | link |



1146364

| PART # | DESCRIPTION | LINK |
|---------|----------------------------|----------------------|
| 1146364 | Booster Axle Lock Cylinder | link |



0085456

| PART # | DESCRIPTION | LINK |
|---------|-----------------------------------|----------------------|
| 0085456 | Accumulator Charge Swivel Fitting | link |



0085886

| PART # | DESCRIPTION | LINK |
|---------|--|----------------------|
| 0085886 | Trailer Axle Cylinder Accumulator Charge Valve | link |



0085455

| PART # | DESCRIPTION | LINK |
|---------|--|----------------------|
| 0085455 | Trailer Axle Cylinder Accumulator Charge Kit | link |



1419184

| PART # | DESCRIPTION | LINK |
|---------|---|----------------------|
| 1419184 | BMV Hydraulic Cylinder Rebuild Exchange | link |



0107577



0108115

| PART # | DESCRIPTION | LINK |
|---------|----------------------------------|----------------------|
| 0107577 | Bridgemaster Cylinder Seal Saver | link |

| PART # | DESCRIPTION | LINK |
|---------|--------------------------------------|----------------------|
| 0108115 | Motion Control Valve Block - Rod End | link |

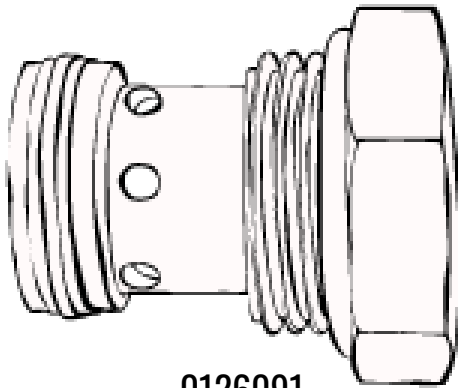

0126091

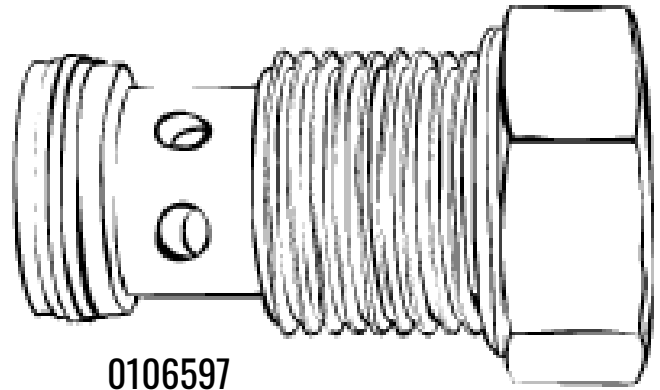

0106597

| PART # | DESCRIPTION | LINK |
|---------|-------------------|----------------------|
| 0126091 | Chute Check Valve | link |

| PART # | DESCRIPTION | LINK |
|---------|-----------------------------|----------------------|
| 0106597 | Hydraulic Chute Check Valve | link |



0108011



1427868

| PART # | DESCRIPTION | LINK |
|---------|-------------|----------------------|
| 0108011 | Fuse Valve | link |

| PART # | DESCRIPTION | LINK |
|---------|--------------------------|----------------------|
| 1427868 | Chute Flow Control Valve | link |

MCNEILUS HYDRAULIC SYSTEM PARTS



0126013

| PART # | DESCRIPTION | LINK |
|---------|--------------|----------------------|
| 0126013 | Needle Valve | link |



0085712

| PART # | DESCRIPTION | LINK |
|---------|-------------------------------|----------------------|
| 0085712 | Chute Block Pilot Check Valve | link |



0106592

| PART # | DESCRIPTION | LINK |
|---------|-------------|----------------------|
| 0106592 | Check Valve | link |



1168120

| PART # | DESCRIPTION | LINK |
|---------|-----------------------------|----------------------|
| 1168120 | Hydraulic Chute Up Solenoid | link |



1426928

| PART # | DESCRIPTION | LINK |
|---------|--------------------------------------|----------------------|
| 1426928 | Chute Flow Control Needle Valve - Up | link |



1168396

| PART # | DESCRIPTION | LINK |
|---------|---|----------------------|
| 1168396 | Chute Solenoid Valve With Coil and Plug | link |



0126551

| PART # | DESCRIPTION | LINK |
|---------|--------------------------|----------------------|
| 0126551 | Single Pilot Check Valve | link |



0085699

| PART # | DESCRIPTION | LINK |
|---------|-------------|----------------------|
| 0085699 | Slump Gauge | link |

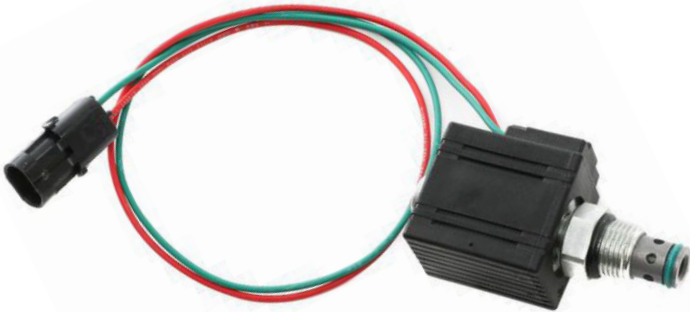

1168121

| PART # | DESCRIPTION | LINK |
|---------|--------------------------------|----------------------|
| 1168121 | Hydraulic Chute Solenoid Valve | link |



0182886

| PART # | DESCRIPTION | LINK |
|---------|---------------------------------|----------------------|
| 0182886 | Hydraulic Reservoir Sight Glass | link |

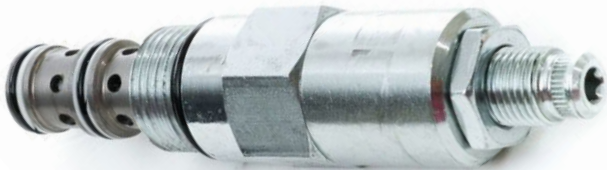

1138940

| PART # | DESCRIPTION | LINK |
|---------|-----------------|----------------------|
| 1138940 | Up Flow Control | link |



0085782

| PART # | DESCRIPTION | LINK |
|---------|----------------------------|----------------------|
| 0085782 | High Pressure Relief Valve | link |

MCNEILUS HYDRAULIC SYSTEM PARTS



1168391

| PART # | DESCRIPTION | LINK |
|--------|-------------|------|
|--------|-------------|------|

| | | |
|---------|-------------------------------|----------------------|
| 1168391 | PTS Valve with Internal Drain | link |
|---------|-------------------------------|----------------------|

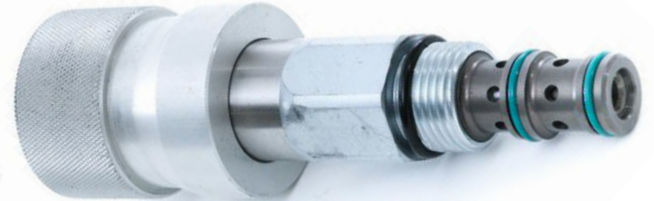

1168394

| PART # | DESCRIPTION | LINK |
|--------|-------------|------|
|--------|-------------|------|

| | | |
|---------|--------------------------|----------------------|
| 1168394 | Pressure Valve With Knob | link |
|---------|--------------------------|----------------------|



0183925

| PART # | DESCRIPTION | LINK |
|--------|-------------|------|
|--------|-------------|------|

| | | |
|---------|-----------------------------|----------------------|
| 0183925 | Drum Control Block Assembly | link |
|---------|-----------------------------|----------------------|



1236356

| PART # | DESCRIPTION | LINK |
|--------|-------------|------|
|--------|-------------|------|

| | | |
|---------|--|----------------------|
| 1236356 | Hydraulic Cooler Assembly - Bottom Ports | link |
|---------|--|----------------------|



0108012

| PART # | DESCRIPTION | LINK |
|--------|-------------|------|
|--------|-------------|------|

| | | |
|---------|--------------------------------|----------------------|
| 0108012 | Bridgemaster V High Flow Block | link |
|---------|--------------------------------|----------------------|



0108576

| PART # | DESCRIPTION | LINK |
|--------|-------------|------|
|--------|-------------|------|

| | | |
|---------|-------------------------------|----------------------|
| 0108576 | Hyd Oil Cooler Fan with Motor | link |
|---------|-------------------------------|----------------------|

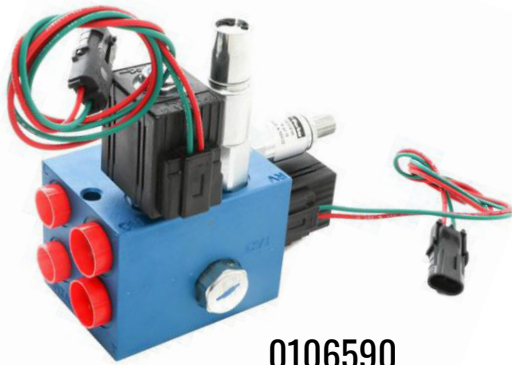

0106590



0082023

| PART # | DESCRIPTION | LINK |
|--------|-------------|------|
|--------|-------------|------|

0106590 Hydraulic Chute Valve Block - Single Acting Open Center [link](#)

| PART # | DESCRIPTION | LINK |
|--------|-------------|------|
|--------|-------------|------|

0082023 Sight Gauge Plug for Hydraulic Tanks - 3/4in [link](#)



0108552



1325302

| PART # | DESCRIPTION | LINK |
|--------|-------------|------|
|--------|-------------|------|

0108552 Filter Can Bowl for 0108550 High Pressure Filter [link](#)

| PART # | DESCRIPTION | LINK |
|--------|-------------|------|
|--------|-------------|------|

1325302 Hydraulic HP Filter Element [link](#)



0106555



0000436

| PART # | DESCRIPTION | LINK |
|--------|-------------|------|
|--------|-------------|------|

0106555 By-Pass Oil Filter Indicator for 108550 [link](#)

| PART # | DESCRIPTION | LINK |
|--------|-------------|------|
|--------|-------------|------|

0000436 Spin-on Filter [link](#)

MCNEILUS HYDRAULIC SYSTEM PARTS



0108550

| PART # | DESCRIPTION | LINK |
|---------|-----------------------------------|----------------------|
| 0108550 | High Pressure Oil Filter Assembly | link |



0108555

| PART # | DESCRIPTION | LINK |
|---------|-------------------------------|----------------------|
| 0108555 | Hydraulic Filter Breather Cap | link |

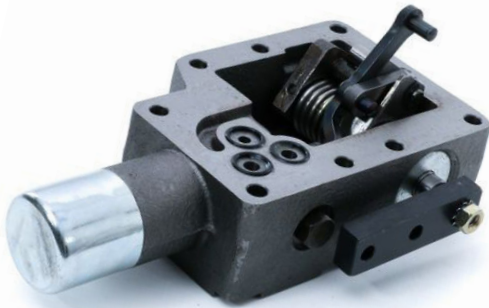

0002245

| PART # | DESCRIPTION | LINK |
|---------|--------------------------|----------------------|
| 0002245 | Sundstrand Control Valve | link |



0002266

| PART # | DESCRIPTION | LINK |
|---------|----------------------------------|----------------------|
| 0002266 | Sundstrand Control Valve Bushing | link |

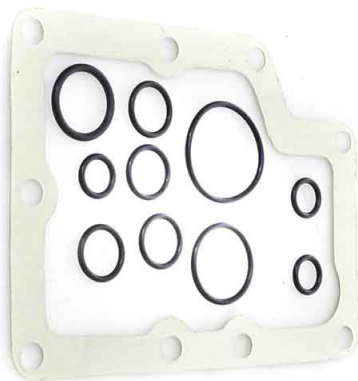

0002228

| PART # | DESCRIPTION | LINK |
|---------|-----------------------------------|----------------------|
| 0002228 | Sundstrand Control Valve Seal Kit | link |

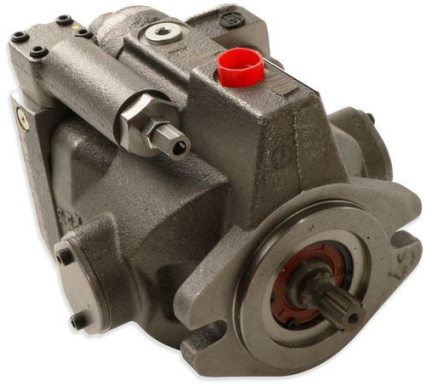

1483222

| PART # | DESCRIPTION | LINK |
|---------|----------------------------------|----------------------|
| 1483222 | Pump - RH Rear Ports Compensator | link |



1167488

| PART # | DESCRIPTION | LINK |
|---------|----------------|----------------------|
| 1167488 | Parker Pump-LH | link |



1167482

| PART # | DESCRIPTION | LINK |
|---------|---|----------------------|
| 1167482 | Cessna Pressure Compensator Pump 5/8X9 LH | link |



1167483

| PART # | DESCRIPTION | LINK |
|---------|---|----------------------|
| 1167483 | Cessna Pressure Compensator Pump 5/8X9 RH | link |

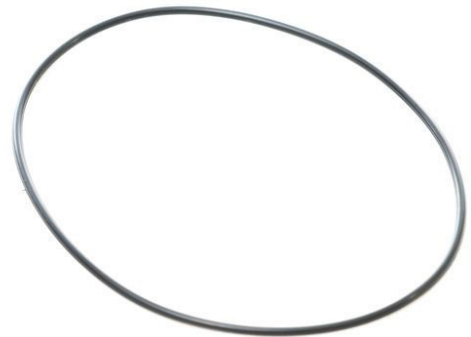

0002439

| PART # | DESCRIPTION | LINK |
|---------|--------------------------|----------------------|
| 0002439 | Eaton Charge Pump O-Ring | link |

MCNEILUS HYDRAULIC SYSTEM PARTS



0002225

| PART # | DESCRIPTION | LINK |
|--------|-------------|------|
|--------|-------------|------|

| | | |
|---------|---------------|----------------------|
| 0002225 | Pump Seal Kit | link |
|---------|---------------|----------------------|



2HP105

| PART # | DESCRIPTION | LINK |
|--------|-------------|------|
|--------|-------------|------|

| | | |
|--------|-------------------------|----------------------|
| 2HP105 | Sundstand Pump Seal Kit | link |
|--------|-------------------------|----------------------|



0002438

| PART # | DESCRIPTION | LINK |
|--------|-------------|------|
|--------|-------------|------|

| | | |
|---------|----------------------------------|----------------------|
| 0002438 | A-Pad Charge Pump Shaft Oil Seal | link |
|---------|----------------------------------|----------------------|

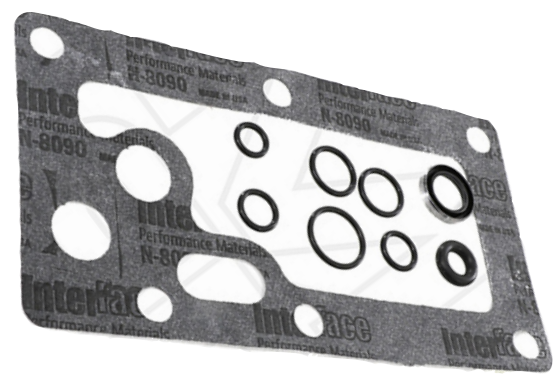

0002468

| PART # | DESCRIPTION | LINK |
|--------|-------------|------|
|--------|-------------|------|

| | | |
|---------|-------------------------------------|----------------------|
| 0002468 | Eaton Control Valve Gasket Seal Kit | link |
|---------|-------------------------------------|----------------------|



0002471

| PART # | DESCRIPTION | LINK |
|--------|-------------|------|
|--------|-------------|------|

| | | |
|---------|-------------------------------|----------------------|
| 0002471 | Eaton A-Pad Charge Pump Shaft | link |
|---------|-------------------------------|----------------------|



0002465

| PART # | DESCRIPTION | LINK |
|--------|-------------|------|
|--------|-------------|------|

| | | |
|---------|---|----------------------|
| 0002465 | Eaton Shaft Seal Kit for 33-54 Series Pumps | link |
|---------|---|----------------------|



0123023



0002000

| PART # | DESCRIPTION | LINK |
|---------|-------------------------------------|----------------------|
| 0123023 | Eaton Pump and Motor Shaft Seal Kit | link |

| PART # | DESCRIPTION | LINK |
|---------|------------------------|----------------------|
| 0002000 | Hydraulic Motor Gasket | link |



0127504



0127510

| PART # | DESCRIPTION | LINK |
|---------|---|----------------------|
| 0127504 | Tapered End Yoke for 1350 Driveline 1-3/8 Tapered Shaft | link |

| PART # | DESCRIPTION | LINK |
|---------|------------------------------|----------------------|
| 0127510 | Conversion U-Joint 1310-1350 | link |



0127503



0127501

| PART # | DESCRIPTION | LINK |
|---------|------------------|----------------------|
| 0127503 | Flange Yoke 1350 | link |

| PART # | DESCRIPTION | LINK |
|---------|-----------------------|----------------------|
| 0127501 | 1350 U-Joint Bolt Kit | link |

MCNEILUS HYDRAULIC SYSTEM PARTS



0127505

| PART # | DESCRIPTION | LINK |
|---------|-------------|----------------------|
| 0127505 | End Yoke | link |



0000704

| PART # | DESCRIPTION | LINK |
|---------|-------------------------|----------------------|
| 0000704 | 1310 Series Flange Yoke | link |



0000760

| PART # | DESCRIPTION | LINK |
|---------|------------------------|----------------------|
| 0000760 | Universal Joint - 1350 | link |



0000700

| PART # | DESCRIPTION | LINK |
|---------|---|----------------------|
| 0000700 | Tapered End Yoke-1310 for 1-3/8in Tapered Shaft | link |



0000703

| PART # | DESCRIPTION | LINK |
|---------|---------------------|----------------------|
| 0000703 | Flange Yoke Adapter | link |



0000702

| PART # | DESCRIPTION | LINK |
|---------|-----------------|----------------------|
| 0000702 | Universal Joint | link |



0013692



0000701

| PART # | DESCRIPTION | LINK |
|--------|-------------|------|
|--------|-------------|------|

| | | |
|---------|----------|----------------------|
| 0013692 | End Yoke | link |
|---------|----------|----------------------|

| PART # | DESCRIPTION | LINK |
|--------|-------------|------|
|--------|-------------|------|

| | | |
|---------|---------------------------|----------------------|
| 0000701 | Driveline U-Bolt Kit-1310 | link |
|---------|---------------------------|----------------------|



1104280



1509901

| PART # | DESCRIPTION | LINK |
|--------|-------------|------|
|--------|-------------|------|

| | | |
|---------|---------------------------------------|----------------------|
| 1104280 | Companion Flange Strap Kit 1350/ 1410 | link |
|---------|---------------------------------------|----------------------|

| PART # | DESCRIPTION | LINK |
|--------|-------------|------|
|--------|-------------|------|

| | | |
|---------|-------------|----------------------|
| 1509901 | Drive Shaft | link |
|---------|-------------|----------------------|



1509883



1508585

| PART # | DESCRIPTION | LINK |
|--------|-------------|------|
|--------|-------------|------|

| | | |
|---------|--|----------------------|
| 1509883 | 18in Closed PTO Drive Shaft with 1350 U-Joints | link |
|---------|--|----------------------|

| PART # | DESCRIPTION | LINK |
|--------|-------------|------|
|--------|-------------|------|

| | | |
|---------|-----------------|----------------------|
| 1508585 | Drive Shaft PTO | link |
|---------|-----------------|----------------------|

MCNEILUS HYDRAULIC SYSTEM PARTS



1509889

| PART # | DESCRIPTION | LINK |
|---------|---|----------------------|
| 1509889 | PTO Drive Shaft with 1350 U-Joints - 14in - 2.5in | link |



0115324R

| PART # | DESCRIPTION | LINK |
|----------|-------------------------------|----------------------|
| 0115324R | ZF Gearbox - Rebuilt Exchange | link |



P7300SK

| PART # | DESCRIPTION | LINK |
|---------|--|----------------------|
| P7300SK | Drum Drive Gearbox Seal and Gasket Kit | link |



0215301

| PART # | DESCRIPTION | LINK |
|---------|---------------------|----------------------|
| 0215301 | Gearbox Output Seal | link |



0215303

| PART # | DESCRIPTION | LINK |
|---------|-------------------|----------------------|
| 0215303 | ZF Retaining Ring | link |



0215563

| PART # | DESCRIPTION | LINK |
|---------|-------------------------|----------------------|
| 0215563 | ZF Gearbox Main Bearing | link |



1397061



0215313

| PART # | DESCRIPTION | LINK |
|---------|-------------------------------|----------------------|
| 1397061 | ZF Drum Drive Vented Dipstick | link |

| PART # | DESCRIPTION | LINK |
|---------|-------------|----------------------|
| 0215313 | Slotted Nut | link |

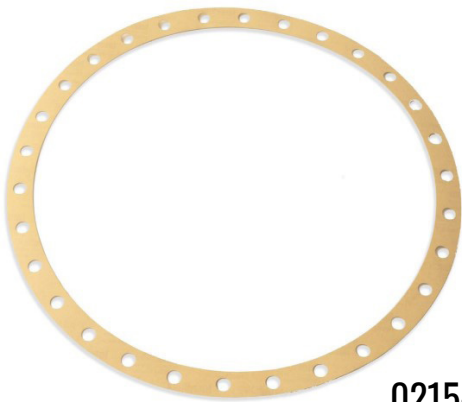

0215402



0215397

| PART # | DESCRIPTION | LINK |
|---------|----------------|----------------------|
| 0215402 | Gearbox Gasket | link |

| PART # | DESCRIPTION | LINK |
|---------|------------------------|----------------------|
| 0215397 | ZF Gearbox Sight Gauge | link |



0215409



0115325R

| PART # | DESCRIPTION | LINK |
|---------|--------------------------|----------------------|
| 0215409 | Gearbox Input Shaft Seal | link |

| PART # | DESCRIPTION | LINK |
|----------|-----------------|----------------------|
| 0115325R | Gearbox-Rebuilt | link |



PK7500SK

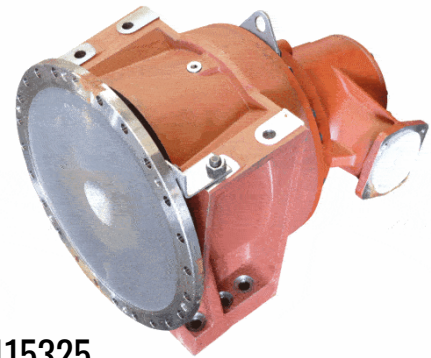

0115325

| PART # | DESCRIPTION | LINK |
|----------|--|----------------------|
| PK7500SK | Drum Drive Gearbox Seal and Gasket Kit | link |

| PART # | DESCRIPTION | LINK |
|---------|-----------------------|----------------------|
| 0115325 | ZF Drum Drive Gearbox | link |



0012945



0014686

| PART # | DESCRIPTION | LINK |
|---------|--------------------------------|----------------------|
| 0012945 | Eaton Pump Control Valve Shaft | link |

| PART # | DESCRIPTION | LINK |
|---------|---------------------------------|----------------------|
| 0014686 | Eaton Control Valve Base O-Ring | link |



0500314



0014225

| PART # | DESCRIPTION | LINK |
|---------|------------------------------------|----------------------|
| 0500314 | Control Valve Lever Arm - 4in Bent | link |

| PART # | DESCRIPTION | LINK |
|---------|------------------------------|----------------------|
| 0014225 | Eaton Control Valve Roll Pin | link |



0002227



0002408

| PART # | DESCRIPTION | LINK |
|---------|-------------------------------|----------------------|
| 0002227 | Eaton Control Valve Connector | link |

| PART # | DESCRIPTION | LINK |
|---------|----------------------------|----------------------|
| 0002408 | Eaton Control Valve Gasket | link |



1134405



1139095

| PART # | DESCRIPTION | LINK |
|---------|--------------------|----------------------|
| 1134405 | Hex Head Cap Screw | link |

| PART # | DESCRIPTION | LINK |
|---------|--|----------------------|
| 1139095 | Drum Charge Discharge Solenoid Coil - RE Control Valve | link |



1274576



1274577

| PART # | DESCRIPTION | LINK |
|---------|--|----------------------|
| 1274576 | RE Control Valve Coil - Start/Stop With 5/8" Shaft | link |

| PART # | DESCRIPTION | LINK |
|---------|---|----------------------|
| 1274577 | RE Control Valve Cartridge - Start/Stop Alternative | link |

MCNEILUS HYDRAULIC CONTROL VALVES



0126223

| PART # | DESCRIPTION | LINK |
|--------|-------------|------|
|--------|-------------|------|

| | | |
|---------|--|----------------------|
| 0126223 | RE Control Manual Bypass Valve with Adj Knob | link |
|---------|--|----------------------|



0126222

| PART # | DESCRIPTION | LINK |
|--------|-------------|------|
|--------|-------------|------|

| | | |
|---------|----------------------------------|----------------------|
| 0126222 | RE Remote Control Valve Assembly | link |
|---------|----------------------------------|----------------------|



0126240

| PART # | DESCRIPTION | LINK |
|--------|-------------|------|
|--------|-------------|------|

| | | |
|---------|-------------------------------|----------------------|
| 0126240 | Eaton RE Control Valve Gasket | link |
|---------|-------------------------------|----------------------|



1257136

| PART # | DESCRIPTION | LINK |
|--------|-------------|------|
|--------|-------------|------|

| | | |
|---------|---------------------------------|----------------------|
| 1257136 | Double Link Control Valve - New | link |
|---------|---------------------------------|----------------------|

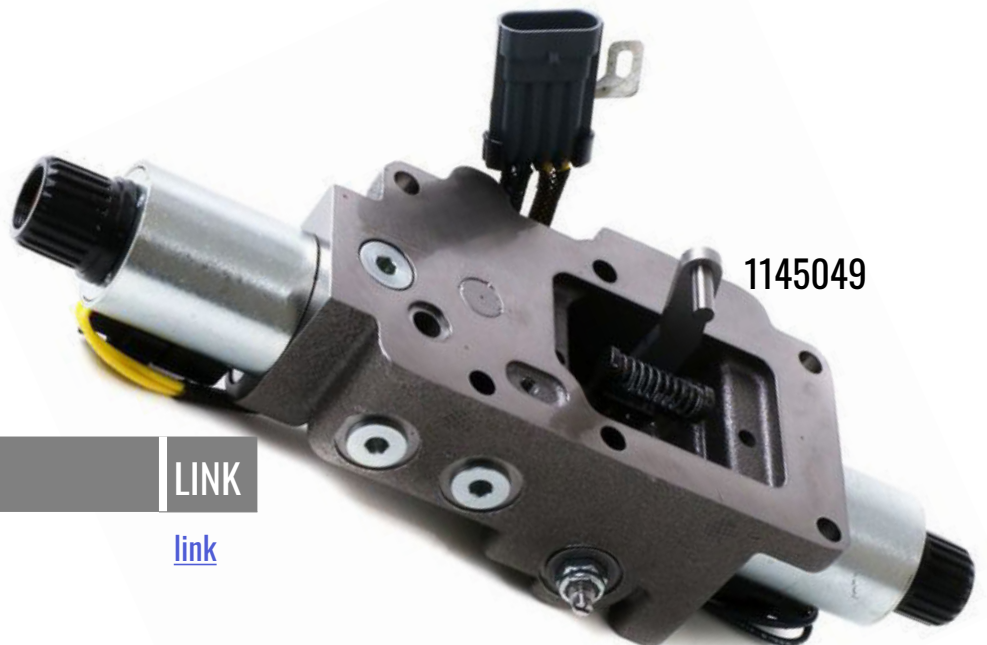

1145049

| PART # | DESCRIPTION | LINK |
|--------|-------------|------|
|--------|-------------|------|

| | | |
|---------|---------------|----------------------|
| 1145049 | Control Valve | link |
|---------|---------------|----------------------|



1140768



1404743

| PART # | DESCRIPTION | LINK |
|---------|--|----------------------|
| 1140768 | Eaton 12V EP Control Valve Coil With Diode | link |

| PART # | DESCRIPTION | LINK |
|---------|--|----------------------|
| 1404743 | Eaton EP Control Cartridge With Capnut O-Ring and Gasket | link |



0106792



1111994

| PART # | DESCRIPTION | LINK |
|---------|-------------------------------------|----------------------|
| 0106792 | Dyna Chute Power Unit - Push Button | link |

| PART # | DESCRIPTION | LINK |
|---------|-------------|----------------------|
| 1111994 | Solenoid | link |



0110184



0106753

| PART # | DESCRIPTION | LINK |
|---------|-------------------------------|----------------------|
| 0110184 | Dyna Chute Push Button Switch | link |

| PART # | DESCRIPTION | LINK |
|---------|--------------------------------|----------------------|
| 0106753 | Dyna Chute Reservoir Vent Plug | link |

MCNEILUS HYDRAULIC CHUTE LIFTERS



0106770



0106784

| PART # | DESCRIPTION | LINK |
|---------|---|----------------------|
| 0106770 | Dyna Chute Manual Chute Lifter Assembly | link |

| PART # | DESCRIPTION | LINK |
|---------|----------------------------------|----------------------|
| 0106784 | Dyna Chute Start Switch Solenoid | link |

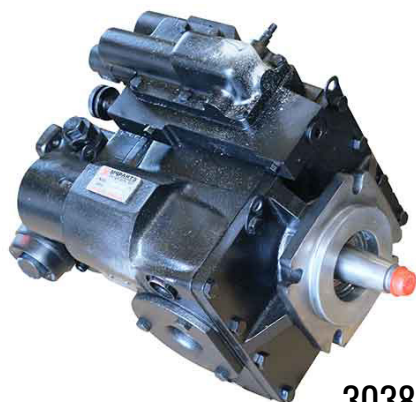

30389138

| PART # | DESCRIPTION | LINK |
|--------|-------------|------|
|--------|-------------|------|

30389138 Hydraulic Pump [link](#)

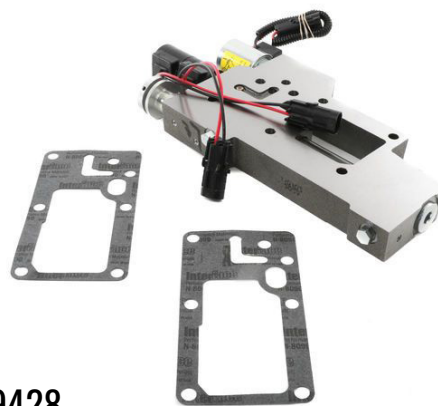

30389428

| PART # | DESCRIPTION | LINK |
|--------|-------------|------|
|--------|-------------|------|

30389428 RE Remote Control Valve for Eaton Pumps [link](#)



30389882

| PART # | DESCRIPTION | LINK |
|--------|-------------|------|
|--------|-------------|------|

30389882 Charge Discharge Solenoid Coil [link](#)



30386195

| PART # | DESCRIPTION | LINK |
|--------|-------------|------|
|--------|-------------|------|

30386195 RE Control Valve Cartridge for Charge Discharge [link](#)



30389877

| PART # | DESCRIPTION | LINK |
|--------|-------------|------|
|--------|-------------|------|

30389877 RE Control Valve Solenoid Coil Pause/Resume or On/Off [link](#)



30386194

| PART # | DESCRIPTION | LINK |
|--------|-------------|------|
|--------|-------------|------|

30386194 Hydraulic Cartridge for Drum Start Stop on the RE Drum Control Valve [link](#)

SCHWING HYDRAULIC SYSTEM PARTS



30386196

| PART # | DESCRIPTION | LINK |
|----------|---|----------------------|
| 30386196 | RE Control Manual Bypass Valve with Adjustment Knob | link |

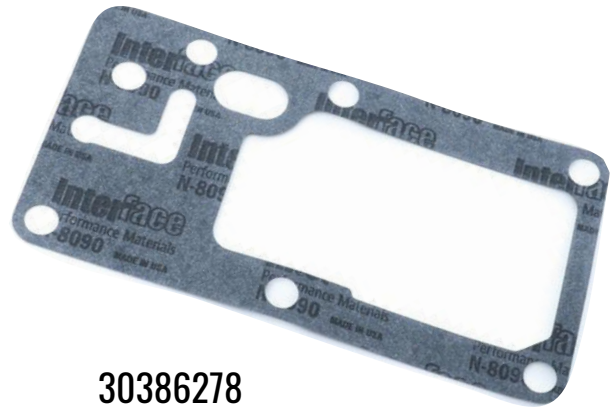

30386278

| PART # | DESCRIPTION | LINK |
|----------|------------------------------|----------------------|
| 30386278 | Pump RE Control Valve Gasket | link |

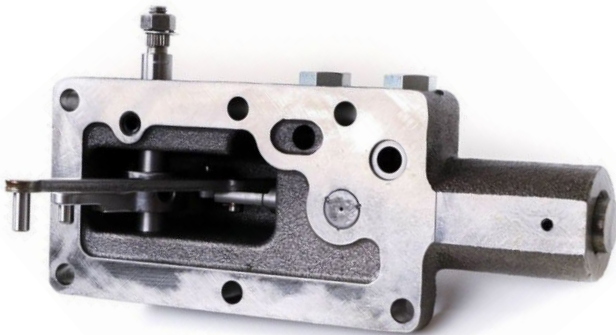

30386667

| PART # | DESCRIPTION | LINK |
|----------|---------------------------------|----------------------|
| 30386667 | Double Link Control Valve - New | link |



30386671

| PART # | DESCRIPTION | LINK |
|----------|-------------------------|----------------------|
| 30386671 | Control Coil with Diode | link |

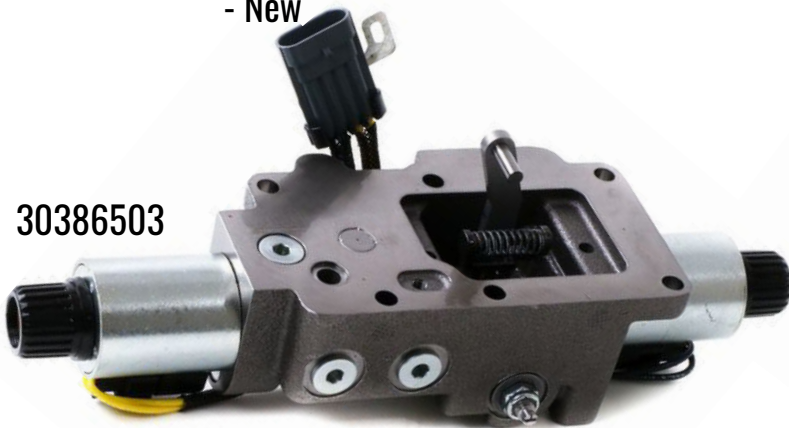

30386503

| PART # | DESCRIPTION | LINK |
|----------|---------------|----------------------|
| 30386503 | Control Valve | link |



30307799

| PART # | DESCRIPTION | LINK |
|----------|---------------------------------|----------------------|
| 30307799 | High Pressure Hose Split Flange | link |

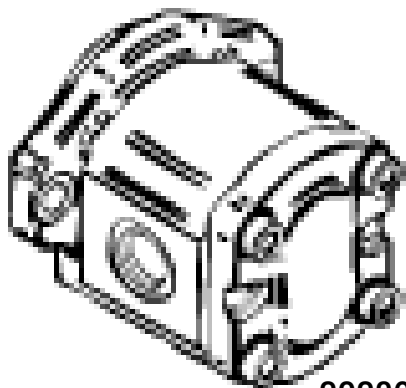

30389203

| PART # | DESCRIPTION | LINK |
|----------|--|----------------------|
| 30389203 | Hydraulic Gear Pump - CCW for Chute Cylinder | link |



30389315

| PART # | DESCRIPTION | LINK |
|----------|---|----------------------|
| 30389315 | Ball Joint - 1/4in x 1/4in Cable Ball Joint | link |

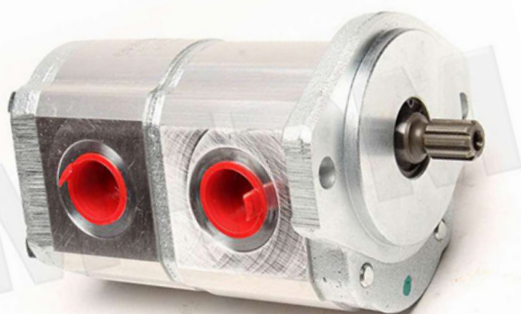

30394674

| PART # | DESCRIPTION | LINK |
|----------|---------------------|----------------------|
| 30394674 | Hydraulic Gear Pump | link |



30386148

| PART # | DESCRIPTION | LINK |
|----------|------------------------------|----------------------|
| 30386148 | Control Valve Gasket - Eaton | link |

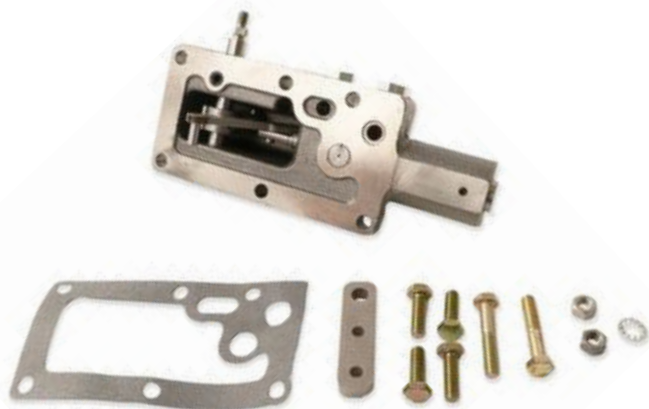

30386670

| PART # | DESCRIPTION | LINK |
|----------|--------------------------|----------------------|
| 30386670 | New Manual Control Valve | link |



30386413

| PART # | DESCRIPTION | LINK |
|----------|--|----------------------|
| 30386413 | Eaton Hydraulic Pump Relief Valve-220# | link |

SCHWING HYDRAULIC SYSTEM PARTS

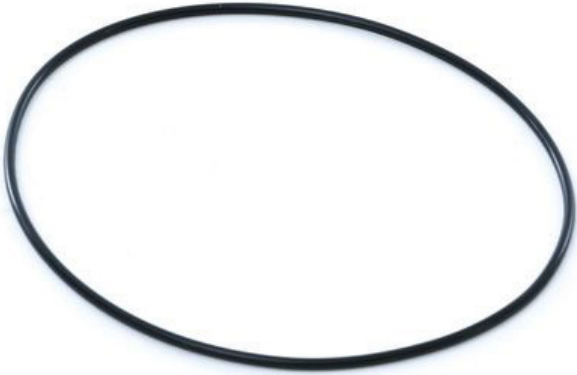

10042863

| PART # | DESCRIPTION | LINK |
|----------|-------------|----------------------|
| 10042863 | O-Ring | link |



30389557

| PART # | DESCRIPTION | LINK |
|----------|---|----------------------|
| 30389557 | 6in Short Charge Pump Pressure Hydraulic Filter Element | link |

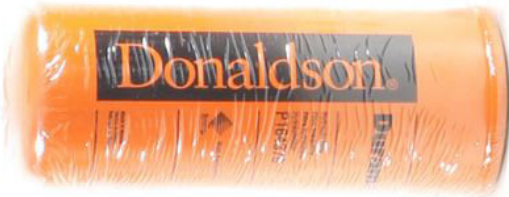

30389448

| PART # | DESCRIPTION | LINK |
|----------|-------------------------------|----------------------|
| 30389448 | Hydraulic Pump Spin On Filter | link |



30389309

| PART # | DESCRIPTION | LINK |
|----------|-------------------------------|----------------------|
| 30389309 | Start/Stop Drum Control Valve | link |



30389205

| PART # | DESCRIPTION | LINK |
|----------|--|----------------------|
| 30389205 | Pump - Side Ports - RH 9 Spline Parker Hydraulic | link |



30318961

| PART # | DESCRIPTION | LINK |
|----------|--------------------------|----------------------|
| 30318961 | Hydraulic Filter Element | link |

SCHWING HYDRAULIC SYSTEM PARTS



30389150

| PART # | DESCRIPTION | LINK |
|--------|-------------|------|
|--------|-------------|------|

| | | |
|----------|------------------------------|----------------------|
| 30389150 | Hydraulic Motor Without HPRV | link |
|----------|------------------------------|----------------------|



30386360

| PART # | DESCRIPTION | LINK |
|--------|-------------|------|
|--------|-------------|------|

| | | |
|----------|--|----------------------|
| 30386360 | Hydraulic Cooler Assembly - Bottom Ports | link |
|----------|--|----------------------|



30386548

| PART # | DESCRIPTION | LINK |
|--------|-------------|------|
|--------|-------------|------|

| | | |
|----------|---|----------------------|
| 30386548 | Hydraulic Oil Cooler Fan Motor Assembly | link |
|----------|---|----------------------|

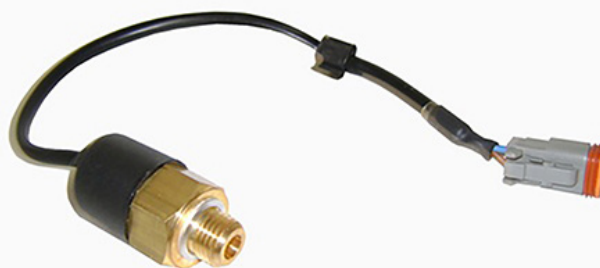

30386549

| PART # | DESCRIPTION | LINK |
|--------|-------------|------|
|--------|-------------|------|

| | | |
|----------|---|----------------------|
| 30386549 | Hydraulic Oil Cooler Temperature Switch | link |
|----------|---|----------------------|



30386149

| PART # | DESCRIPTION | LINK |
|--------|-------------|------|
|--------|-------------|------|

| | | |
|----------|---|----------------------|
| 30386149 | Mixer Hydraulic Oil Cooler Fan/Motor Assembly | link |
|----------|---|----------------------|



30389924

| PART # | DESCRIPTION | LINK |
|--------|-------------|------|
|--------|-------------|------|

| | | |
|----------|-----------------------|----------------------|
| 30389924 | 3/4in Oil Sight Gauge | link |
|----------|-----------------------|----------------------|

SCHWING HYDRAULIC SYSTEM PARTS

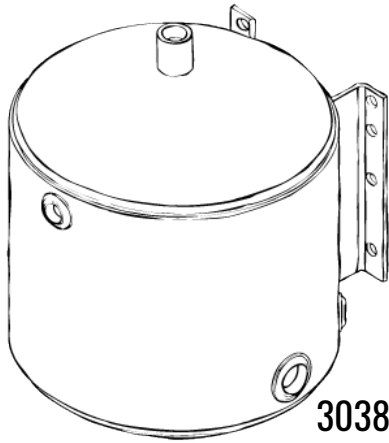

30389278



30389925

| PART # | DESCRIPTION | LINK |
|----------|--------------------------|----------------------|
| 30389278 | Hydraulic Tank 12 Gallon | link |

| PART # | DESCRIPTION | LINK |
|----------|------------------|----------------------|
| 30389925 | Tank Breather-1" | link |

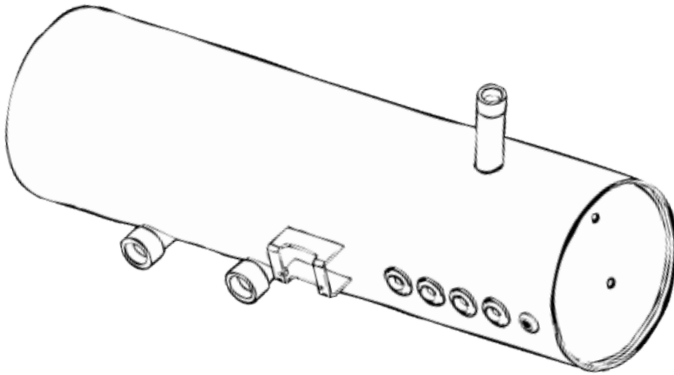

30389148

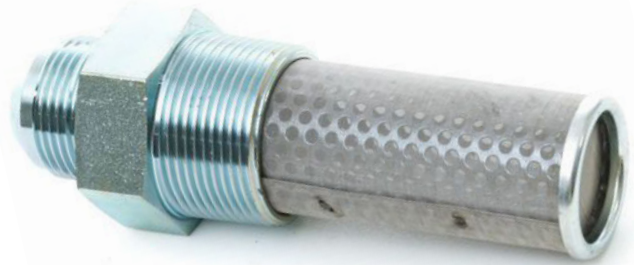

30389719

| PART # | DESCRIPTION | LINK |
|----------|-------------------------------|----------------------|
| 30389148 | 18 Gallon Hydraulic Reservoir | link |

| PART # | DESCRIPTION | LINK |
|----------|-------------------------------------|----------------------|
| 30389719 | Hydraulic Oil Tank Strainer Fitting | link |



10012911



30389149

| PART # | DESCRIPTION | LINK |
|----------|-----------------------------|----------------------|
| 10012911 | Glass Level Indicator Gauge | link |

| PART # | DESCRIPTION | LINK |
|----------|---|----------------------|
| 30389149 | Hydraulic High Pressure Oil Filter Assembly | link |



30389984



98349423

| PART # | DESCRIPTION | LINK |
|--------|-------------|------|
|--------|-------------|------|

| | | |
|----------|-----------------------------|----------------------|
| 30389984 | Hydraulic HP Filter Element | link |
|----------|-----------------------------|----------------------|

| PART # | DESCRIPTION | LINK |
|--------|-------------|------|
|--------|-------------|------|

| | | |
|----------|---|----------------------|
| 98349423 | Seal Kit for 30389813 Chute Lift Cylinder | link |
|----------|---|----------------------|



30389145



30389130

| PART # | DESCRIPTION | LINK |
|--------|-------------|------|
|--------|-------------|------|

| | | |
|----------|---|----------------------|
| 30389145 | Mixer Double Acting Chute Lift Cylinder | link |
|----------|---|----------------------|

| PART # | DESCRIPTION | LINK |
|--------|-------------|------|
|--------|-------------|------|

| | | |
|----------|-----------------------------------|----------------------|
| 30389130 | Trailer Lock Cylinder - Hydraulic | link |
|----------|-----------------------------------|----------------------|



60104083



30386337

| PART # | DESCRIPTION | LINK |
|--------|-------------|------|
|--------|-------------|------|

| | | |
|----------|------------|----------------------|
| 60104083 | ZF Gearbox | link |
|----------|------------|----------------------|

| PART # | DESCRIPTION | LINK |
|--------|-------------|------|
|--------|-------------|------|

| | | |
|----------|----------------------------|----------------------|
| 30386337 | Gearbox - Rebuilt Exchange | link |
|----------|----------------------------|----------------------|

SCHWING HYDRAULIC SYSTEM PARTS

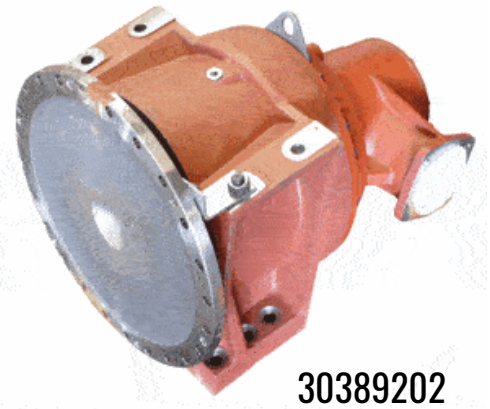

30389202



98334203

| PART # | DESCRIPTION | LINK |
|----------|------------------------------|----------------------|
| 30389202 | New Mixer Drum Drive Gearbox | link |

| PART # | DESCRIPTION | LINK |
|----------|-----------------------------------|----------------------|
| 98334203 | New Ecomix II Gear Box Drum Drive | link |



30389319

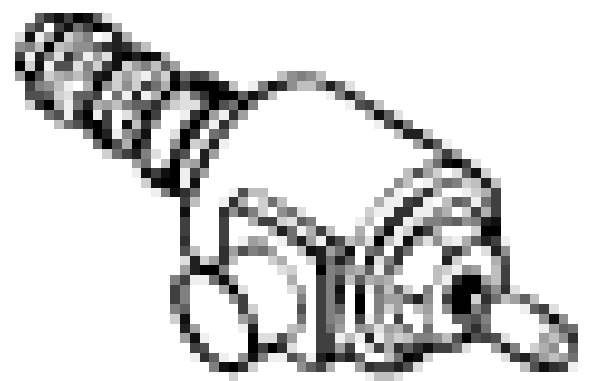

30389547

| PART # | DESCRIPTION | LINK |
|----------|------------------------|----------------------|
| 30389319 | Chute Block Flow Valve | link |

| PART # | DESCRIPTION | LINK |
|----------|--|----------------------|
| 30389547 | Hydraulic Chute Block Cartridge and Coil | link |



30389542



30389539

| PART # | DESCRIPTION | LINK |
|----------|----------------------------|----------------------|
| 30389542 | Hydraulic Chute Block Coil | link |

| PART # | DESCRIPTION | LINK |
|----------|--|----------------------|
| 30389539 | Hydraulic Chute Block Cartridge with Coils for Chute Up/Down | link |

SCHWING HYDRAULIC SYSTEM PARTS



30389541

| PART # | DESCRIPTION | LINK |
|----------|-------------------------|----------------------|
| 30389541 | Chute Up/Down Cartridge | link |



30389537

| PART # | DESCRIPTION | LINK |
|----------|--------------------------|----------------------|
| 30389537 | Valve Cartridge Seal Kit | link |



30389318

| PART # | DESCRIPTION | LINK |
|----------|---------------------------|----------------------|
| 30389318 | Control Block Check Valve | link |



30389135

| PART # | DESCRIPTION | LINK |
|----------|-------------------------------------|----------------------|
| 30389135 | Chute Control Hydraulic Valve Block | link |

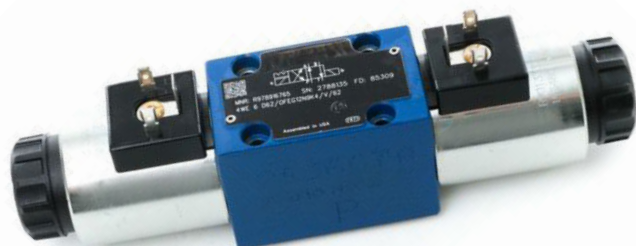

30389545

| PART # | DESCRIPTION | LINK |
|----------|-------------------------------------|----------------------|
| 30389545 | Hydraulic Directional Control Valve | link |



30389546

| PART # | DESCRIPTION | LINK |
|----------|---------------|----------------------|
| 30389546 | Solenoid Coil | link |

SCHWING HYDRAULIC SYSTEM PARTS



30389543

| PART # | DESCRIPTION | LINK |
|--------|-------------|------|
|--------|-------------|------|

| | | |
|----------|-----------------------------------|----------------------|
| 30389543 | Hydraulic Pressure Reducing Valve | link |
|----------|-----------------------------------|----------------------|



30389544

| PART # | DESCRIPTION | LINK |
|--------|-------------|------|
|--------|-------------|------|

| | | |
|----------|-------------------------|----------------------|
| 30389544 | Pressure Valve Seal Kit | link |
|----------|-------------------------|----------------------|



30389134

| PART # | DESCRIPTION | LINK |
|--------|-------------|------|
|--------|-------------|------|

| | | |
|----------|--|----------------------|
| 30389134 | Booster Hydraulic Chute Control Block Assembly | link |
|----------|--|----------------------|



30389692

| PART # | DESCRIPTION | LINK |
|--------|-------------|------|
|--------|-------------|------|

| | | |
|----------|--------------------------------|----------------------|
| 30389692 | 5000# Hydraulic Pressure Gauge | link |
|----------|--------------------------------|----------------------|

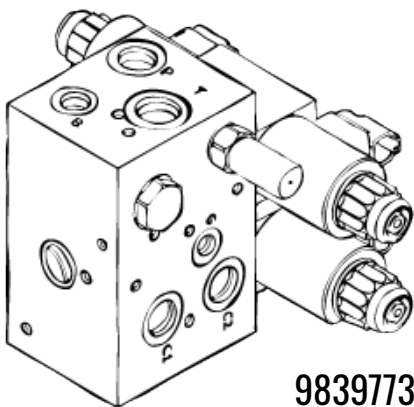

98397730

| PART # | DESCRIPTION | LINK |
|--------|-------------|------|
|--------|-------------|------|

| | | |
|----------|-------------|----------------------|
| 98397730 | Combo Block | link |
|----------|-------------|----------------------|

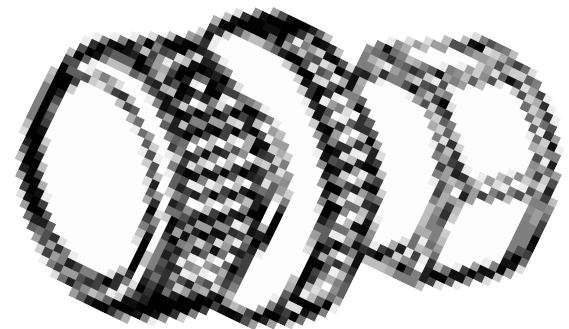

10194895

| PART # | DESCRIPTION | LINK |
|--------|-------------|------|
|--------|-------------|------|

| | | |
|----------|---|----------------------|
| 10194895 | Hydraulic Pressure Reducing Valve Cartridge | link |
|----------|---|----------------------|

SCHWING HYDRAULIC SYSTEM PARTS



10202974

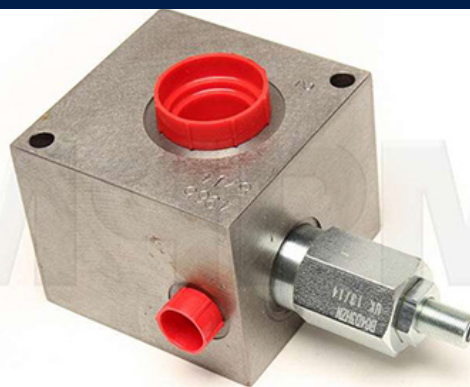

10200209

| PART # | DESCRIPTION | LINK |
|--------|-------------|------|
|--------|-------------|------|

| | | |
|----------|---------------------------------------|----------------------|
| 10202974 | Cartridge Valve Seal Kit for 10200202 | link |
|----------|---------------------------------------|----------------------|

| PART # | DESCRIPTION | LINK |
|--------|-------------|------|
|--------|-------------|------|

| | | |
|----------|----------------------------|----------------------|
| 10200209 | Hyd Pressure Control Block | link |
|----------|----------------------------|----------------------|



30389536

| PART # | DESCRIPTION | LINK |
|--------|-------------|------|
|--------|-------------|------|

| | | |
|----------|---------------------|----------------------|
| 30389536 | 0.025" Orifice Disc | link |
|----------|---------------------|----------------------|



30389533

| PART # | DESCRIPTION | LINK |
|--------|-------------|------|
|--------|-------------|------|

| | | |
|----------|-----------------------|----------------------|
| 30389533 | Seal Kit for 30389532 | link |
|----------|-----------------------|----------------------|

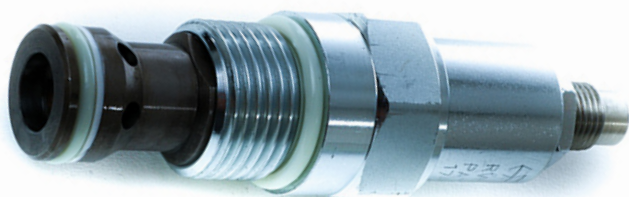

30389532

| PART # | DESCRIPTION | LINK |
|--------|-------------|------|
|--------|-------------|------|

| | | |
|----------|------------------------|----------------------|
| 30389532 | Hydraulic Relief Valve | link |
|----------|------------------------|----------------------|

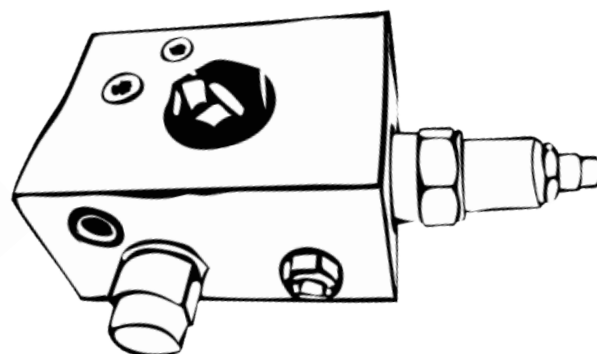

30389132

| PART # | DESCRIPTION | LINK |
|--------|-------------|------|
|--------|-------------|------|

| | | |
|----------|---|----------------------|
| 30389132 | Hydraulic Valve Piston End Booster Axle | link |
|----------|---|----------------------|

SCHWING HYDRAULIC SYSTEM PARTS



30389170

| PART # | DESCRIPTION | LINK |
|----------|----------------------|----------------------|
| 30389170 | Steel O-Ring Fitting | link |



30386650

| PART # | DESCRIPTION | LINK |
|----------|---------------------------------|----------------------|
| 30386650 | Hydraulic Counter Balance Valve | link |



30389133

| PART # | DESCRIPTION | LINK |
|----------|------------------------------|----------------------|
| 30389133 | Rod End Axle Hydraulic Valve | link |



30386262

| PART # | DESCRIPTION | LINK |
|----------|---|----------------------|
| 30386262 | 2.25in Inner Diameter Booster Cylinder Ball Bushing | link |



30389131

| PART # | DESCRIPTION | LINK |
|----------|---|----------------------|
| 30389131 | 4.5in x 4.5in x 31.88in Bridgemaster Cylinder | link |



30389131EX

| PART # | DESCRIPTION | LINK |
|------------|-------------------------------|----------------------|
| 30389131EX | BMIII Remanufactured Cylinder | link |



30389146

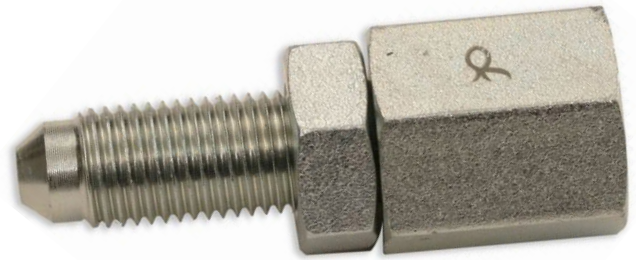

30389275

| PART # | DESCRIPTION | LINK |
|----------|---|----------------------|
| 30389146 | Hydraulic Pressure Gauge 0-5000PSI 1/4in NPT 4in Diameter | link |

| PART # | DESCRIPTION | LINK |
|----------|--|----------------------|
| 30389275 | Fitting - Hyd. Female Bulkhead 1/4" NPT | link |



30389212

| PART # | DESCRIPTION | LINK |
|----------|---|----------------------|
| 30389212 | Fitting - Hyd Tee #4 37de- gree Swivel Nut Run | link |

BECK INTERSTATE CLASS/ BRIDGE AXLE



| PART # | DESCRIPTION | LINK |
|--------|--|----------------------|
| 12360 | Booster Cylinder Ball Bushing - 2.25 inch ID | link |

| PART # | DESCRIPTION | LINK |
|--------|--|----------------------|
| 12371 | Steering Stabilizer Shock with Dust Cover Shield | link |



CBMW BOOSTER AXLES

51620765



90251200



| PART # | DESCRIPTION | LINK |
|----------|--|----------------------|
| 51620765 | Booster Cylinder Ball Bushing - 2.25in | link |

| PART # | DESCRIPTION | LINK |
|----------|-------------------------------|----------------------|
| 90251200 | BMIII Remanufactured Cylinder | link |

90251201



90620106

| PART # | DESCRIPTION | LINK |
|----------|-------------------------|----------------------|
| 90251201 | Nitrogen Pressure Gauge | link |

| PART # | DESCRIPTION | LINK |
|----------|--------------------|----------------------|
| 90620106 | Cylinder Pivot Pin | link |



90620105

90620107

| PART # | DESCRIPTION | LINK |
|----------|-------------------------|----------------------|
| 90620105 | Cylinder Pin Snap Rings | link |

| PART # | DESCRIPTION | LINK |
|----------|----------------------------|----------------------|
| 90620107 | Cylinder Pivot Pin Spacers | link |

CBMW BOOSTER AXLES

90620101

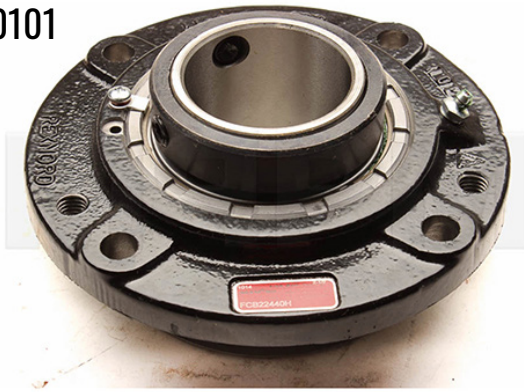

90620730



| PART # | DESCRIPTION | LINK |
|----------|--|----------------------|
| 90620101 | Booster Axle Trailer Arm Bearing - Bridgesaver | link |

| PART # | DESCRIPTION | LINK |
|----------|-------------------------------------|----------------------|
| 90620730 | Booster Arm Pivot Pin - Bridgesaver | link |

81620039



40620031



| PART # | DESCRIPTION | LINK |
|----------|----------------------------|----------------------|
| 81620039 | Axle Steering Damper Shock | link |

| PART # | DESCRIPTION | LINK |
|----------|------------------------------------|----------------------|
| 40620031 | Steering Stabilizer Shock Absorber | link |

90640019



90640020



| PART # | DESCRIPTION | LINK |
|----------|--|----------------------|
| 90640019 | Left Side Axle Fender Mounting Bracket | link |

| PART # | DESCRIPTION | LINK |
|----------|---|----------------------|
| 90640020 | Right Side Axle Fender Mounting Bracket | link |

CBMW BOOSTER AXLES

90640033



90640034



| PART # | DESCRIPTION | LINK |
|----------|--|----------------------|
| 90640033 | Left Hand Axle Fender Mounting Bracket | link |

| PART # | DESCRIPTION | LINK |
|----------|---|----------------------|
| 90640034 | Right Hand Axle Fender Mounting Bracket | link |

90640017



90640018



| PART # | DESCRIPTION | LINK |
|----------|---|----------------------|
| 90640017 | Universal Booster Axle Fender - Left Hand Plastic | link |

| PART # | DESCRIPTION | LINK |
|----------|--|----------------------|
| 90640018 | Universal Booster Axle Fender - Right Hand Plastic | link |

NO IMAGE AVAILABLE

90620110

| PART # | DESCRIPTION | LINK |
|----------|--------------|----------------------|
| 90620110 | Cross Member | link |

90626608



| PART # | DESCRIPTION | LINK |
|----------|-------------------------------|----------------------|
| 90626608 | Bridgesaver Rod Cap Block Set | link |

CON-TECH AXLES

750051



792105



| PART # | DESCRIPTION | LINK |
|--------|-------------|------|
|--------|-------------|------|

| | | |
|--------|--------------------------------|----------------------|
| 750051 | Booster Pivot Urethane Bushing | link |
|--------|--------------------------------|----------------------|

| PART # | DESCRIPTION | LINK |
|--------|-------------|------|
|--------|-------------|------|

| | | |
|--------|------------------------------------|----------------------|
| 792105 | Ride Air Bag for Hendrickson SCT13 | link |
|--------|------------------------------------|----------------------|

792106



792103

| PART # | DESCRIPTION | LINK |
|--------|-------------|------|
|--------|-------------|------|

| | | |
|--------|----------------------------------|----------------------|
| 792106 | Up Air Bag for Hendrickson SCT13 | link |
|--------|----------------------------------|----------------------|

| PART # | DESCRIPTION | LINK |
|--------|-------------|------|
|--------|-------------|------|

| | | |
|--------|--------------------------------|----------------------|
| 792103 | Composite Bolt and Bushing Kit | link |
|--------|--------------------------------|----------------------|

790005



| PART # | DESCRIPTION | LINK |
|--------|-------------|------|
|--------|-------------|------|

| | | |
|--------|------------------------------------|----------------------|
| 790005 | Steering Stabilizer Shock Absorber | link |
|--------|------------------------------------|----------------------|

HOUSBY BRIDGE AXLES

16981



| PART # | DESCRIPTION | LINK |
|--------|--------------------------------|----------------------|
| 16981 | Greasy Bolt for Tag Axle Pivot | link |

18685



| PART # | DESCRIPTION | LINK |
|--------|-------------|----------------------|
| 18685 | Bolt | link |

18840B



| PART # | DESCRIPTION | LINK |
|--------|---------------|----------------------|
| 18840B | Pivot Bushing | link |

19188



| PART # | DESCRIPTION | LINK |
|--------|----------------|----------------------|
| 19188 | Tapered Sleeve | link |

19191

NO IMAGE AVAILABLE

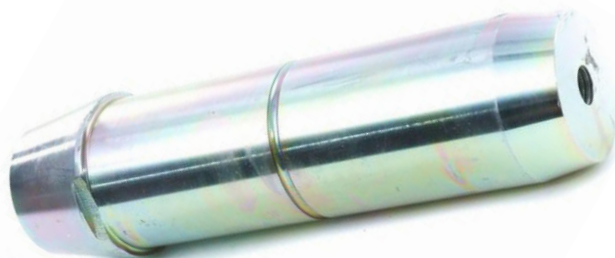

19190

| PART # | DESCRIPTION | LINK |
|--------|------------------|----------------------|
| 19190 | Bridge Pivot Pin | link |

| PART # | DESCRIPTION | LINK |
|--------|-------------|----------------------|
| 19191 | Wear Pad | link |

HOUSBY BRIDGE AXLES

19189



19162

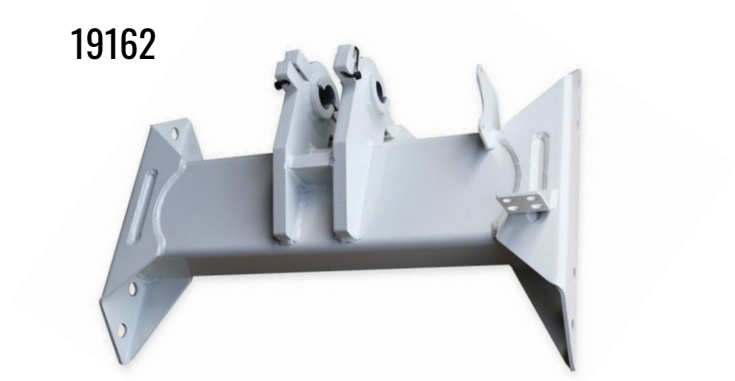

| PART # | DESCRIPTION | LINK |
|--------|--------------|----------------------|
| 19189 | Mount Washer | link |

| PART # | DESCRIPTION | LINK |
|--------|---------------------------|----------------------|
| 19162 | Trailer Axle Cross Member | link |

21572C3



| PART # | DESCRIPTION | LINK |
|---------|------------------------------|----------------------|
| 21572C3 | Pusher Axle Tie Rod Assembly | link |

KIMBLE TRAILER WHEEL END

T910000200



| PART # | DESCRIPTION | LINK |
|------------|--------------------------------|----------------------|
| T910000200 | Axle Steering Stabilizer Shock | link |

T411200145



| PART # | DESCRIPTION | LINK |
|------------|--|----------------------|
| T411200145 | Axle King Pin Kit - 1.794 in x 9.05 in | link |

T411200171



| PART # | DESCRIPTION | LINK |
|------------|------------------------------------|----------------------|
| T411200171 | King Pin Kit Set less Foam Inserts | link |

LONDON AXLES

MB3773730



700040



| PART # | DESCRIPTION | LINK | PART # | DESCRIPTION | LINK |
|-----------|------------------------------------|----------------------|--------|--------------|----------------------|
| MB3773730 | Steering Stabilizer Shock Absorber | link | 700040 | King Pin Kit | link |

700042



| PART # | DESCRIPTION | LINK |
|--------|-------------|----------------------|
| 700042 | Tie Rod End | link |



0188206

| PART # | DESCRIPTION | LINK |
|---------|-------------------------------|----------------------|
| 0188206 | Shock, Axle, BM V, with Cover | link |



1170719

| PART # | DESCRIPTION | LINK |
|---------|----------------------------|----------------------|
| 1170719 | Axle Steering Damper Shock | link |

1275119

NO IMAGE AVAILABLE

| PART # | DESCRIPTION | LINK |
|---------|-------------------------|----------------------|
| 1275119 | BRAKE ASM 15 X 4 / L.H. | link |



1275113

| PART # | DESCRIPTION | LINK |
|---------|---------------|----------------------|
| 1275113 | Thrust Washer | link |

1275120

NO IMAGE AVAILABLE

| PART # | DESCRIPTION | LINK |
|---------|-------------------------|----------------------|
| 1275120 | BRAKE ASM 15 X 4 / R.H. | link |



1275115

| PART # | DESCRIPTION | LINK |
|---------|-------------|----------------------|
| 1275115 | .009in Shim | link |

MCNEILUS AXLES

1139105



1275173



| PART # | DESCRIPTION | LINK |
|--------|-------------|------|
|--------|-------------|------|

1139105 Knuckle/Spindle Nut & Slotted Washer [link](#)

| PART # | DESCRIPTION | LINK |
|--------|-------------|------|
|--------|-------------|------|

1275173 Trailer Axle Tie Rod Assembly - Bridgemaster V [link](#)



1272503

| PART # | DESCRIPTION | LINK |
|--------|-------------|------|
|--------|-------------|------|

1272503 Air Down Airspring Airbag [link](#)



1272505

| PART # | DESCRIPTION | LINK |
|--------|-------------|------|
|--------|-------------|------|

1272505 Axle Pin [link](#)

1272494



| PART # | DESCRIPTION | LINK |
|--------|-------------|------|
|--------|-------------|------|

1272494 Pivot Bushing [link](#)

1272531



| PART # | DESCRIPTION | LINK |
|--------|-------------|------|
|--------|-------------|------|

1272531 Rigid Torque Arm with Bushings [link](#)

3HS768



| PART # | DESCRIPTION | LINK |
|--------|---------------------|----------------------|
| 3HS768 | Bellows Down Airbag | link |

1272516



| PART # | DESCRIPTION | LINK |
|---------|--------------------|----------------------|
| 1272516 | Torque Rod Bushing | link |

1272497



| PART # | DESCRIPTION | LINK |
|---------|---------------------|----------------------|
| 1272497 | Lift Plate Assembly | link |

1272500



| PART # | DESCRIPTION | LINK |
|---------|--------------|----------------------|
| 1272500 | Cross Member | link |

0125059

NO IMAGE AVAILABLE



0189933

| PART # | DESCRIPTION | LINK |
|---------|---------------------------|----------------------|
| 0189933 | Wheel Bearing Slotted Nut | link |

| PART # | DESCRIPTION | LINK |
|---------|---------------|----------------------|
| 0125059 | Thrust Washer | link |

MCNEILUS AXLES

0188026

NO IMAGE
AVAILABLE

0188055



| PART # | DESCRIPTION | LINK |
|---------|--------------------|----------------------|
| 0188026 | Taper Bearing Cone | link |

| PART # | DESCRIPTION | LINK |
|---------|---------------------------|----------------------|
| 0188055 | Kingpin Bushing Composite | link |



| PART # | DESCRIPTION | LINK |
|---------|---------------------------|----------------------|
| 0188051 | Screw-In Cap King Pin Kit | link |



1168923

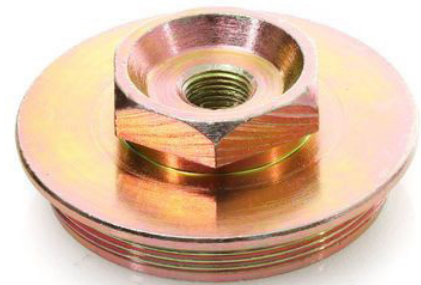

| PART # | DESCRIPTION | LINK |
|---------|----------------------|----------------------|
| 1168923 | Screw on Kingpin Cap | link |

0188011



| PART # | DESCRIPTION | LINK |
|---------|-----------------|----------------------|
| 0188011 | Flanged Locknut | link |

0188013



| PART # | DESCRIPTION | LINK |
|---------|--------------------------|----------------------|
| 0188013 | Tie Rod Arm Woodruff Key | link |

0189189



| PART # | DESCRIPTION | LINK |
|---------|-----------------------|----------------------|
| 0189189 | Axle Tie Rod Assembly | link |

0188001

NO IMAGE AVAILABLE

| PART # | DESCRIPTION | LINK |
|---------|--------------------|----------------------|
| 0188001 | Right Steering Arm | link |

0188002

NO IMAGE AVAILABLE

| PART # | DESCRIPTION | LINK |
|---------|-------------------|----------------------|
| 0188002 | Left Steering Arm | link |

0125057



| PART # | DESCRIPTION | LINK |
|---------|---------------------|----------------------|
| 0125057 | Cross Tube Assembly | link |



0125072

| PART # | DESCRIPTION | LINK |
|---------|-------------|----------------------|
| 0125072 | Tie Rod End | link |

0125071



| PART # | DESCRIPTION | LINK |
|---------|------------------------------------|----------------------|
| 0125071 | Tie Rod End for Advance Drag Links | link |

SCHWING AXLES

98375683

NO IMAGE AVAILABLE

30386606



| PART # | DESCRIPTION | LINK |
|----------|-----------------------------|----------------------|
| 98375683 | Standard Mixer Booster Axle | link |

| PART # | DESCRIPTION | LINK |
|----------|--------------------------------|----------------------|
| 30386606 | Pivot Bushing Bracket, Booster | link |

30386609

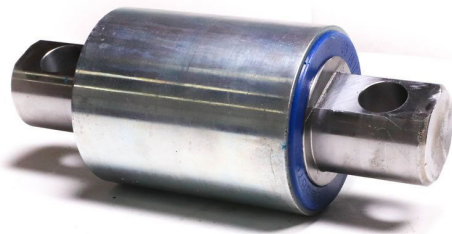

30386610

NO IMAGE AVAILABLE

| PART # | DESCRIPTION | LINK |
|----------|--------------------------------|----------------------|
| 30386609 | Booster Pivot Urethane Bushing | link |

| PART # | DESCRIPTION | LINK |
|----------|--------------|----------------------|
| 30386610 | Trailer Axle | link |

30386416



30389839



| PART # | DESCRIPTION | LINK |
|----------|--|----------------------|
| 30386416 | Spring Over Shock Absorber - Steering Stabilizer | link |

| PART # | DESCRIPTION | LINK |
|----------|---|----------------------|
| 90640020 | Right Side Axle Fender Mounting Bracket | link |

**PAGE
INTENTIONALLY
LEFT BLANK**

CONTROL CABLES

| BRAND | PART # | DESCRIPTION |
|-------|--------|-------------|
|-------|--------|-------------|

| | | |
|----------|------------------------|--------------------------|
| Con-Tech | 780048 | 4ft (48in) Control Cable |
|----------|------------------------|--------------------------|

| | | |
|----------|-------------------------|--------------------------|
| McNeilus | 0115802 | 4ft (48in) Control Cable |
|----------|-------------------------|--------------------------|

| BRAND | PART # | DESCRIPTION |
|-------|--------|-------------|
|-------|--------|-------------|

| | | |
|----------|------------------------|----------------------------|
| Con-Tech | 780054 | 4.5ft (54in) Control Cable |
|----------|------------------------|----------------------------|

| BRAND | PART # | DESCRIPTION |
|-------|--------|-------------|
|-------|--------|-------------|

| | | |
|------|------------------------|--------------------------|
| Beck | 32060W | 5ft (60in) Control Cable |
|------|------------------------|--------------------------|

| | | |
|----------|-------------------------|--------------------------|
| McNeilus | 0215805 | 5ft (60in) Control Cable |
|----------|-------------------------|--------------------------|

| | | |
|------|--------------------------|--------------------------|
| CBMW | 10424259 | 5ft (60in) Control Cable |
|------|--------------------------|--------------------------|

| | | |
|----------|------------------------|--------------------------|
| Con-Tech | 780060 | 5ft (60in) Control Cable |
|----------|------------------------|--------------------------|

| BRAND | PART # | DESCRIPTION |
|-------|--------|-------------|
|-------|--------|-------------|

| | | |
|------|------------------------|--------------------------|
| Beck | 32072W | 6ft (72in) Control Cable |
|------|------------------------|--------------------------|

| | | |
|----------|-------------------------|--------------------------|
| McNeilus | 0215806 | 6ft (72in) Control Cable |
|----------|-------------------------|--------------------------|

| | | |
|------|--------------------------|--------------------------|
| CBMW | 10424260 | 6ft (72in) Control Cable |
|------|--------------------------|--------------------------|

| | | |
|----------|------------------------|--------------------------|
| Con-Tech | 780072 | 6ft (72in) Control Cable |
|----------|------------------------|--------------------------|

| BRAND | PART # | DESCRIPTION |
|-------|--------|-------------|
|-------|--------|-------------|

| | | |
|------|------------------------|--------------------------|
| Beck | 32084W | 7ft (84in) Control Cable |
|------|------------------------|--------------------------|

| | | |
|----------|-------------------------|--------------------------|
| McNeilus | 0215807 | 7ft (84in) Control Cable |
|----------|-------------------------|--------------------------|

| | | |
|------|--------------------------|--------------------------|
| CBMW | 10424261 | 7ft (84in) Control Cable |
|------|--------------------------|--------------------------|

| | | |
|----------|------------------------|--------------------------|
| Con-Tech | 780084 | 7ft (84in) Control Cable |
|----------|------------------------|--------------------------|

CONTROL CABLES CONT.

| BRAND | PART # | DESCRIPTION |
|----------|--------------------------|--------------------------|
| Beck | 32096W | 8ft (96in) Control Cable |
| McNeilus | 0215808 | 8ft (96in) Control Cable |
| CBMW | 10424262 | 8ft (96in) Control Cable |
| Con-Tech | 780096 | 8ft (96in) Control Cable |

| BRAND | PART # | DESCRIPTION |
|----------|--------------------------|---------------------------|
| CBMW | 10424263 | 9ft (108in) Control Cable |
| McNeilus | 0215809 | 9ft (108in) Control Cable |

| BRAND | PART # | DESCRIPTION |
|----------|--------------------------|----------------------------|
| Beck | 32120W | 10ft (120in) Control Cable |
| McNeilus | 0215810 | 10ft (120in) Control Cable |
| CBMW | 10424264 | 10ft (120in) Control Cable |

| BRAND | PART # | DESCRIPTION |
|----------|--------------------------|----------------------------|
| CBMW | 10424266 | 12ft (144in) Control Cable |
| Con-Tech | 780144 | 12ft (144in) Control Cable |
| McNeilus | 0215812 | 12ft (144in) Control Cable |

| BRAND | PART # | DESCRIPTION |
|----------|--------------------------|----------------------------|
| Beck | 32156W | 13ft (156in) Control Cable |
| McNeilus | 0215813 | 13ft (156in) Control Cable |
| CBMW | 10424267 | 13ft (156in) Control Cable |

CONTROL CABLES CONT.

| BRAND | PART # | DESCRIPTION |
|----------|--------------------------|----------------------------|
| Beck | 32168W | 14ft (168in) Control Cable |
| McNeilus | 0215814 | 14ft (168in) Control Cable |
| CBMW | 10424268 | 14ft (168in) Control Cable |
| BRAND | PART # | DESCRIPTION |
| CBMW | 10424269 | 15ft (180in) Control Cable |
| McNeilus | 0215815 | 15ft (180in) Control Cable |
| BRAND | PART # | DESCRIPTION |
| CBMW | 10424270 | 16ft (192in) Control Cable |
| Con-Tech | 780192 | 16ft (192in) Control Cable |
| McNeilus | 0215816 | 16ft (192in) Control Cable |
| BRAND | PART # | DESCRIPTION |
| Beck | 32204W | 17ft (204in) Control Cable |
| McNeilus | 0215817 | 17ft (204in) Control Cable |
| CBMW | 10424271 | 17ft (204in) Control Cable |
| Con-Tech | 780204 | 17ft (204in) Control Cable |
| BRAND | PART # | DESCRIPTION |
| Beck | 32216W | 18ft (216in) Control Cable |
| McNeilus | 0215818 | 18ft (216in) Control Cable |
| CBMW | 10424272 | 18ft (216in) Control Cable |
| Con-Tech | 780216 | 18ft (216in) Control Cable |
| Schwing | 30389331 | 18ft (216in) Control Cable |

| BRAND | PART # | DESCRIPTION |
|----------|--------------------------|----------------------------|
| Beck | 32228W | 19ft (228in) Control Cable |
| McNeilus | 0215819 | 19ft (228in) Control Cable |
| CBMW | 10424273 | 19ft (228in) Control Cable |

| BRAND | PART # | DESCRIPTION |
|----------|--------------------------|----------------------------|
| Beck | 32240W | 20ft (240in) Control Cable |
| McNeilus | 0215820 | 20ft (240in) Control Cable |
| CBMW | 10424274 | 20ft (240in) Control Cable |
| Con-Tech | 780240 | 20ft (240in) Control Cable |

| BRAND | PART # | DESCRIPTION |
|----------|--------------------------|----------------------------|
| Beck | 32252W | 21ft (252in) Control Cable |
| McNeilus | 0215821 | 21ft (252in) Control Cable |
| CBMW | 10424275 | 21ft (252in) Control Cable |
| Con-Tech | 780252 | 21ft (252in) Control Cable |

| BRAND | PART # | DESCRIPTION |
|----------|--------------------------|----------------------------|
| Beck | 32264W | 22ft (264in) Control Cable |
| McNeilus | 0215822 | 22ft (264in) Control Cable |
| CBMW | 10424276 | 22ft (264in) Control Cable |
| Con-Tech | 780264 | 22ft (264in) Control Cable |

CONTROL CABLES CONT.

| BRAND | PART # | DESCRIPTION |
|----------|--------------------------|----------------------------|
| Beck | 32276W | 23ft (276in) Control Cable |
| McNeilus | 0215823 | 23ft (276in) Control Cable |
| CBMW | 10424277 | 23ft (276in) Control Cable |
| Con-Tech | 780276 | 23ft (276in) Control Cable |

| BRAND | PART # | DESCRIPTION |
|----------|--------------------------|----------------------------|
| Beck | 32288W | 24ft (288in) Control Cable |
| McNeilus | 0215824 | 24ft (288in) Control Cable |
| CBMW | 10424278 | 24ft (288in) Control Cable |
| Con-Tech | 780288 | 24ft (288in) Control Cable |

| BRAND | PART # | DESCRIPTION |
|----------|--------------------------|----------------------------|
| CBMW | 10424279 | 25ft (300in) Control Cable |
| Con-Tech | 780300 | 25ft (300in) Control Cable |
| McNeilus | 0215825 | 25ft (300in) Control Cable |

| BRAND | PART # | DESCRIPTION |
|----------|--------------------------|----------------------------|
| Beck | 32312W | 26ft (312in) Control Cable |
| McNeilus | 0215826 | 26ft (312in) Control Cable |
| CBMW | 10424280 | 26ft (312in) Control Cable |
| Con-Tech | 780312 | 26ft (312in) Control Cable |

CONTROL CABLES CONT.

| BRAND | PART # | DESCRIPTION |
|----------|--------------------------|----------------------------|
| Beck | 32324W | 27ft (324in) Control Cable |
| McNeilus | 0215827 | 27ft (324in) Control Cable |
| CBMW | 10424281 | 27ft (324in) Control Cable |

| BRAND | PART # | DESCRIPTION |
|----------|--------------------------|----------------------------|
| Beck | 32336W | 28ft (336in) Control Cable |
| McNeilus | 0215828 | 28ft (336in) Control Cable |
| CBMW | 10424282 | 28ft (336in) Control Cable |

| BRAND | PART # | DESCRIPTION |
|----------|--------------------------|----------------------------|
| CBMW | 10424283 | 29ft (348in) Control Cable |
| McNeilus | 0215829 | 29ft (348in) Control Cable |

| BRAND | PART # | DESCRIPTION |
|----------|--------------------------|----------------------------|
| CBMW | 10424207 | 33ft (396in) Control Cable |
| Con-Tech | 780396 | 33ft (396in) Control Cable |



32200W

| PART # | DESCRIPTION | LINK |
|--------|----------------------------------|----------------------|
| 32200W | 33ft of 4in Throw Throttle Cable | link |



32600

| PART # | DESCRIPTION | LINK |
|--------|--------------------------------|----------------------|
| 32600 | 1/4in-28 Cable Clevis Assembly | link |

BECK CONTROLS

31170



319006REH



| PART # | DESCRIPTION | LINK |
|--------|-------------|------|
|--------|-------------|------|

| | | |
|-------|-------------------------------------|----------------------|
| 31170 | 6 Function 12 Foot Pendant Assembly | link |
|-------|-------------------------------------|----------------------|

| PART # | DESCRIPTION | LINK |
|--------|-------------|------|
|--------|-------------|------|

| | | |
|-----------|--------------------------------|----------------------|
| 319006REH | Pivot Bushing Bracket, Booster | link |
|-----------|--------------------------------|----------------------|

36120



36100

| PART # | DESCRIPTION | LINK |
|--------|-------------|------|
|--------|-------------|------|

| | | |
|-------|--------------------------------|----------------------|
| 36120 | Rocker Switch - On Off Red Red | link |
|-------|--------------------------------|----------------------|

| PART # | DESCRIPTION | LINK |
|--------|-------------|------|
|--------|-------------|------|

| | | |
|-------|---|----------------------|
| 36100 | 3 Position Momentary Cab Station Switch | link |
|-------|---|----------------------|

31000



78212



| PART # | DESCRIPTION | LINK |
|--------|-------------|------|
|--------|-------------|------|

| | | |
|-------|------------------|----------------------|
| 31000 | Rear Control Box | link |
|-------|------------------|----------------------|

| PART # | DESCRIPTION | LINK |
|--------|-------------|------|
|--------|-------------|------|

| | | |
|-------|------------------|----------------------|
| 78212 | Rear Control Box | link |
|-------|------------------|----------------------|

31011



31014



| PART # | DESCRIPTION | LINK |
|--------|------------------------|----------------------|
| 78212 | Rear Control Lever Arm | link |

| PART # | DESCRIPTION | LINK |
|--------|-----------------------|----------------------|
| 31014 | Rear Control Knob Kit | link |

31015



31012

| PART # | DESCRIPTION | LINK |
|--------|---------------------------|----------------------|
| 31015 | Red Rear Control Knob Kit | link |

| PART # | DESCRIPTION | LINK |
|--------|--------------------|----------------------|
| 31012 | Cab Control Handle | link |

31021



31022



| PART # | DESCRIPTION | LINK |
|--------|-------------|----------------------|
| 31021 | Washer | link |

| PART # | DESCRIPTION | LINK |
|--------|-------------|----------------------|
| 31022 | O-Ring | link |

BECK CONTROLS

31023



| PART # | DESCRIPTION | LINK |
|--------|-------------------------|----------------------|
| 31023 | Rear Control Lever Shim | link |

31018



| PART # | DESCRIPTION | LINK |
|--------|-------------------------------|----------------------|
| 31018 | Rear Control Drum Lever Plate | link |

31019



| PART # | DESCRIPTION | LINK |
|--------|-----------------------------------|----------------------|
| 31019 | Throttle Rear Control Lever Plate | link |

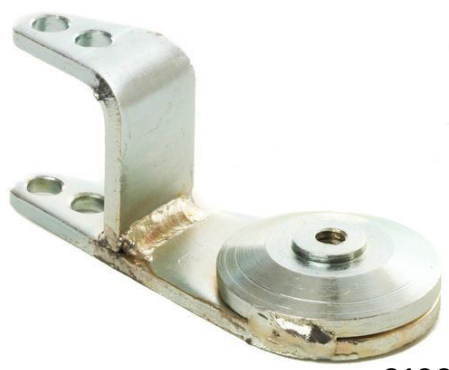

31020

| PART # | DESCRIPTION | LINK |
|--------|----------------------------|----------------------|
| 31020 | Cab Control Lever Assembly | link |

32201



| PART # | DESCRIPTION | LINK |
|--------|-------------|----------------------|
| 32201 | Stop Collar | link |



33010

| PART # | DESCRIPTION | LINK |
|--------|---|----------------------|
| 33010 | Magnetic Pencil Proximity Drum Counter Sensor | link |

33012



33015

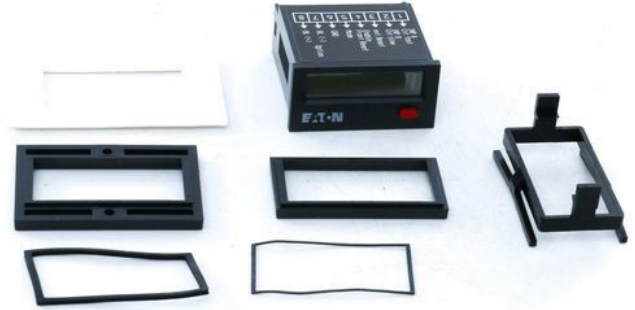

| PART # | DESCRIPTION | LINK |
|--------|----------------------------|----------------------|
| 33012 | Magnetic Drum Counter Bolt | link |

| PART # | DESCRIPTION | LINK |
|--------|---------------------------------------|----------------------|
| 33015 | Digital Drum Counter with LCD Display | link |

34000S



35100

| PART # | DESCRIPTION | LINK |
|--------|-------------------------------------|----------------------|
| 34000S | On Off Toggle Switch With Pigtailed | link |

| PART # | DESCRIPTION | LINK |
|--------|--|----------------------|
| 35100 | Half Toggle Switch Boot with Black Guard | link |

36000S



32700



| PART # | DESCRIPTION | LINK |
|--------|---|----------------------|
| 36000S | Black Dipped Toggle Switch with Pigtailed | link |

| PART # | DESCRIPTION | LINK |
|--------|---|----------------------|
| 32700 | Ball Joint - 1/4in x 1/4in Quick Disconnect | link |

CBMW CONTROLS

10801808

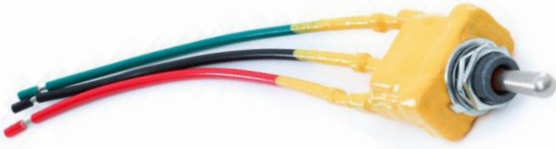

| PART # | DESCRIPTION | LINK |
|--------|-------------|------|
|--------|-------------|------|

| | | |
|----------|--|----------------------|
| 10801808 | Control On/Off/On Momentary Yellow Dipped Toggle Switch with Pigtailed | link |
|----------|--|----------------------|

10801810

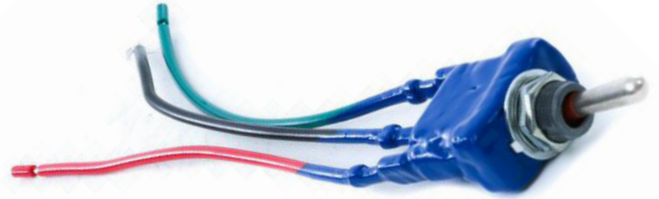

| PART # | DESCRIPTION | LINK |
|--------|-------------|------|
|--------|-------------|------|

| | | |
|----------|----------------------|----------------------|
| 10801810 | Blue Electric Switch | link |
|----------|----------------------|----------------------|

10801815

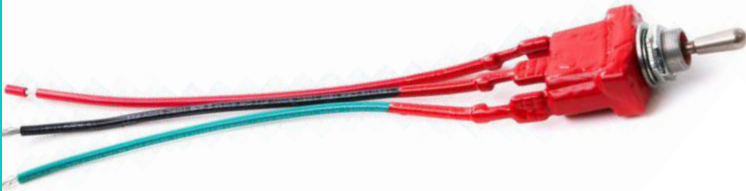

| PART # | DESCRIPTION | LINK |
|--------|-------------|------|
|--------|-------------|------|

| | | |
|----------|---|----------------------|
| 10801815 | Control On/Off/On Red Dipped Toggle Switch with Pigtailed | link |
|----------|---|----------------------|



10802203

| PART # | DESCRIPTION | LINK |
|--------|-------------|------|
|--------|-------------|------|

| | | |
|----------|--|----------------------|
| 10802203 | Electric Rocker Switch for Cab Control | link |
|----------|--|----------------------|

10802205



| PART # | DESCRIPTION | LINK |
|--------|-------------|------|
|--------|-------------|------|

| | | |
|----------|--|----------------------|
| 10802205 | Spring Over Shock Absorber - Steering Stabilizer | link |
|----------|--|----------------------|

10802206



| PART # | DESCRIPTION | LINK |
|--------|-------------|------|
|--------|-------------|------|

| | | |
|----------|--|----------------------|
| 10802206 | Rocker Switch - Interlock Bridgemaster | link |
|----------|--|----------------------|

10802213



10802214



| PART # | DESCRIPTION | LINK | PART # | DESCRIPTION | LINK |
|----------|-----------------------------|----------------------|----------|------------------------|----------------------|
| 10802213 | Chute Control Paddle Switch | link | 10802214 | Electric Rocker Switch | link |

10802215



10801634

| PART # | DESCRIPTION | LINK | PART # | DESCRIPTION | LINK |
|----------|---|----------------------|----------|--------------------------|----------------------|
| 10802215 | Rocker Switch for Cooler Fan - On Off Red | link | 10801634 | Chute Lift Rocker Switch | link |

90401330



| PART # | DESCRIPTION | LINK |
|----------|--|----------------------|
| 90401330 | Remote Control Pendant - Yellow Housing with 10ft Cord | link |
| 90402330 | Remote Control Pendant - Yellow Housing with 12ft Cord | link |
| 90406330 | Remote Control Pendant - Yellow Housing with 20ft Cord | link |

CBMW CONTROLS

10800808

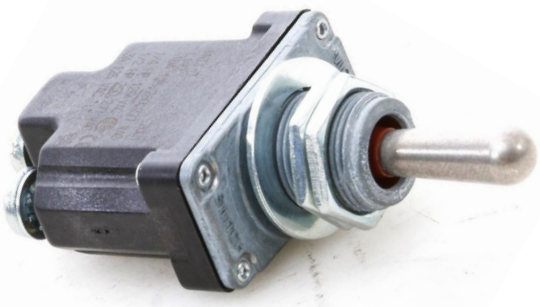

| PART # | DESCRIPTION | LINK |
|----------|-----------------------------|----------------------|
| 10800808 | 2-Position Momentary Switch | link |

10800810



| PART # | DESCRIPTION | LINK |
|----------|-----------------------------|----------------------|
| 10800810 | On Off Sealed Toggle Switch | link |

50412200



| PART # | DESCRIPTION | LINK |
|----------|--------------------------------|----------------------|
| 50412200 | In Cab Control Handle Assembly | link |



50412190

| PART # | DESCRIPTION | LINK |
|----------|-----------------------------|----------------------|
| 50412190 | Black Rear Control Knob Kit | link |

50412260



| PART # | DESCRIPTION | LINK |
|----------|---------------------------|----------------------|
| 50412260 | In Cab Control Handle Kit | link |

50412100



| PART # | DESCRIPTION | LINK |
|----------|---------------------------|----------------------|
| 50412100 | Rear Control Box Assembly | link |

50412106

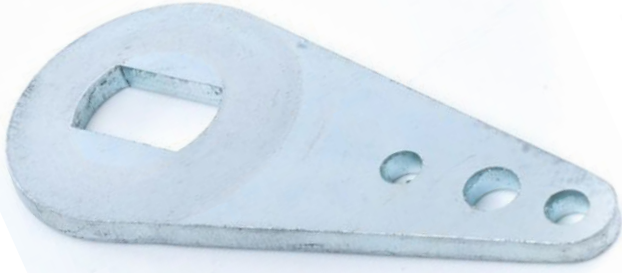

50412102



| PART # | DESCRIPTION | LINK |
|----------|-------------|----------------------|
| 50412106 | Control Arm | link |

| PART # | DESCRIPTION | LINK |
|----------|---------------|----------------------|
| 50412102 | Control Lever | link |

50412107



50412105

| PART # | DESCRIPTION | LINK |
|----------|-------------|----------------------|
| 50412107 | Flat Washer | link |

| PART # | DESCRIPTION | LINK |
|----------|-------------------------|----------------------|
| 50412105 | 1in x 1.985in OD Washer | link |

50412104



50412108



| PART # | DESCRIPTION | LINK |
|----------|---------------|----------------------|
| 50412104 | Rubber Washer | link |

| PART # | DESCRIPTION | LINK |
|----------|-----------------------------------|----------------------|
| 50412108 | Flange Lock Nut for Control Lever | link |

CBMW CONTROLS

80412124



80412125



| PART # | DESCRIPTION | LINK | PART # | DESCRIPTION | LINK |
|----------|---------------------------|----------------------|----------|-----------------------------|----------------------|
| 80412124 | Rear Control Knob Kit-Red | link | 80412125 | Rear Control Knob Kit-Green | link |

50412160



50412200



| PART # | DESCRIPTION | LINK | PART # | DESCRIPTION | LINK |
|----------|-----------------------------|----------------------|----------|--------------------------------|----------------------|
| 50412160 | Rear Control Box Handle Kit | link | 50412200 | In Cab Control Handle Assembly | link |



10802214

50412190



| PART # | DESCRIPTION | LINK | PART # | DESCRIPTION | LINK |
|----------|------------------------|----------------------|----------|-----------------------------|----------------------|
| 10802214 | Electric Rocker Switch | link | 50412190 | Black Rear Control Knob Kit | link |

10432608



| PART # | DESCRIPTION | LINK |
|----------|----------------------|----------------------|
| 10432608 | Digital Drum Counter | link |

10802203



| PART # | DESCRIPTION | LINK |
|----------|--|----------------------|
| 10802203 | Electric Rocker Switch for Cab Control | link |

50412201



| PART # | DESCRIPTION | LINK |
|----------|--|----------------------|
| 50412201 | In Cab Control Arm for Tombstone Control Box | link |

50412214



| PART # | DESCRIPTION | LINK |
|----------|-------------------------------|----------------------|
| 50412214 | .25in Control Box Cable Pivot | link |

50412260



| PART # | DESCRIPTION | LINK |
|----------|---------------------------|----------------------|
| 50412260 | In Cab Control Handle Kit | link |

no image available

90412500

| PART # | DESCRIPTION | LINK |
|----------|-----------------------------|----------------------|
| 90412500 | In Cab Control Box Assembly | link |

CON-TECH CONTROLS

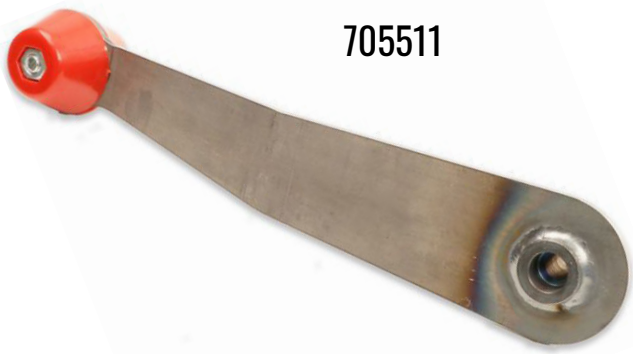

705511

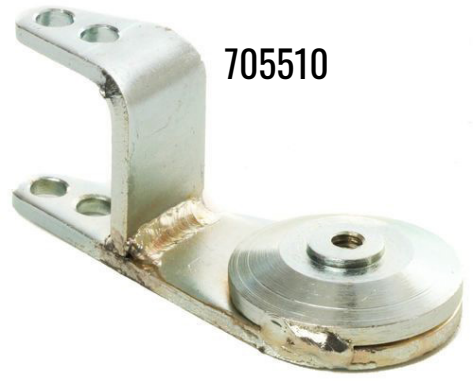

705510

| PART # | DESCRIPTION | LINK |
|--------|--------------------|----------------------|
| 705511 | Cab Control Handle | link |

| PART # | DESCRIPTION | LINK |
|--------|----------------------------|----------------------|
| 705510 | Cab Control Lever Assembly | link |



285185



715152

| PART # | DESCRIPTION | LINK |
|--------|---------------------|----------------------|
| 285185 | Rocker Switch Plate | link |

| PART # | DESCRIPTION | LINK |
|--------|-------------------|----------------------|
| 715152 | Fan Control Relay | link |



715565



715604

| PART # | DESCRIPTION | LINK |
|--------|------------------------|----------------------|
| 715565 | 15 AMP Circuit Breaker | link |

| PART # | DESCRIPTION | LINK |
|--------|---|----------------------|
| 715604 | Rocker Switch - DBL Momentary with Paddle | link |

715605



715606



| PART # | DESCRIPTION | LINK |
|--------|-------------|------|
|--------|-------------|------|

| PART # | DESCRIPTION | LINK |
|--------|-------------|------|
|--------|-------------|------|

715605 3 Position Momentary Cab Station Switch [link](#)

715606 Pivot Bushing Bracket, Booster [link](#)

715607



715608

| PART # | DESCRIPTION | LINK |
|--------|-------------|------|
|--------|-------------|------|

| PART # | DESCRIPTION | LINK |
|--------|-------------|------|
|--------|-------------|------|

715607 Rocker Switch - Bridge-master In Motion [link](#)

715608 Rocker Switch [link](#)

715670



715672



| PART # | DESCRIPTION | LINK |
|--------|-------------|------|
|--------|-------------|------|

| PART # | DESCRIPTION | LINK |
|--------|-------------|------|
|--------|-------------|------|

715670 2-Position Black Rocker Switch for Drum Control On-Off [link](#)

715672 Electric Rocker Switch 3 Spades, 2 Position [link](#)

CON-TECH CONTROLS

765011



| PART # | DESCRIPTION | LINK |
|--------|------------------------------------|----------------------|
| 765011 | Knuckle with Black Knob Adjustment | link |

715656



| PART # | DESCRIPTION | LINK |
|--------|--------------------|----------------------|
| 715656 | Push Button Switch | link |

715650



| PART # | DESCRIPTION | LINK |
|--------|-------------|----------------------|
| 715650 | Push Button | link |



715655

| PART # | DESCRIPTION | LINK |
|--------|---------------------------------|----------------------|
| 715655 | Electric Red Push Button Switch | link |

715665



| PART # | DESCRIPTION | LINK |
|--------|-------------------------------------|----------------------|
| 715665 | Momentary x Momentary Rocker Switch | link |

715300



| PART # | DESCRIPTION | LINK |
|--------|------------------|----------------------|
| 715300 | Cab Buzzer Alarm | link |

715009

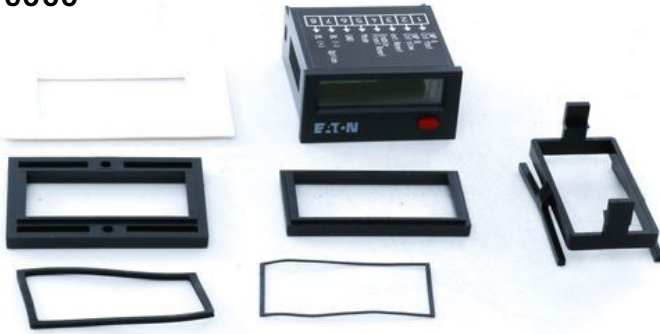

285766



| PART # | DESCRIPTION | LINK |
|--------|-------------|------|
|--------|-------------|------|

| PART # | DESCRIPTION | LINK |
|--------|-------------|------|
|--------|-------------|------|

715009 Digital Drum Counter with [link](#)
LCD Display

285766 Inside Control Handle [link](#)
Ram Mount Control Tear

765031



765034

| PART # | DESCRIPTION | LINK |
|--------|-------------|------|
|--------|-------------|------|

| PART # | DESCRIPTION | LINK |
|--------|-------------|------|
|--------|-------------|------|

765031 Omnex Remote Control [link](#)
Unit

765034 Omnex Remote Weather [link](#)
Guard Pouch

715010



715018



| PART # | DESCRIPTION | LINK |
|--------|-------------|------|
|--------|-------------|------|

| PART # | DESCRIPTION | LINK |
|--------|-------------|------|
|--------|-------------|------|

715010 Magnetic Pencil Proximity [link](#)
Drum Counter Sensor

715018 Magnetic Drum Counter [link](#)
Bolt



285040

| PART # | DESCRIPTION | LINK |
|--------|--|----------------------|
| 285040 | Magnetic Drum Counter Proximity Sensor Bracket | link |

765000



| PART # | DESCRIPTION | LINK |
|--------|---------------------|----------------------|
| 765000 | Control Box Housing | link |



765001

| PART # | DESCRIPTION | LINK |
|--------|---|----------------------|
| 765001 | Rear Control Box - Single Handle for Throttle | link |



765003

| PART # | DESCRIPTION | LINK |
|--------|-----------------------------|----------------------|
| 765003 | Two Handle Rear Control Box | link |

285759



| PART # | DESCRIPTION | LINK |
|--------|------------------------|----------------------|
| 285759 | Rear Control Lever Arm | link |

705508



| PART # | DESCRIPTION | LINK |
|--------|---------------------------|----------------------|
| 705508 | Rear Control Knob Kit-Red | link |

705509



705501

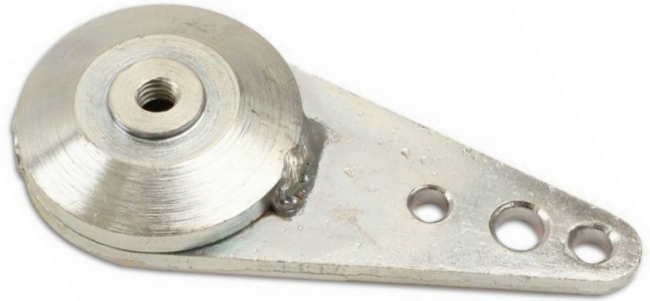

| PART # | DESCRIPTION | LINK |
|--------|-------------------------------|----------------------|
| 705509 | Rear Control Knob Kit - Green | link |

| PART # | DESCRIPTION | LINK |
|--------|---------------------------------|----------------------|
| 705501 | Rear Control Lever Plate - Drum | link |

705502

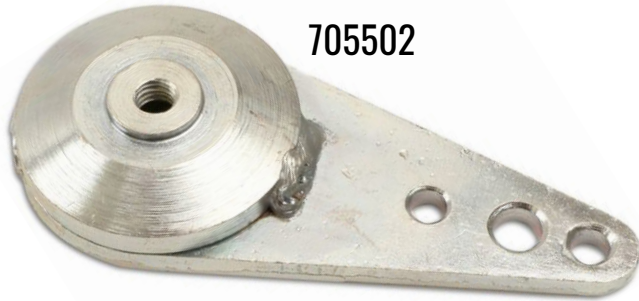

| PART # | DESCRIPTION | LINK |
|--------|-------------------------------------|----------------------|
| 705502 | Rear Control Lever Plate - Throttle | link |



705512

| PART # | DESCRIPTION | LINK |
|--------|---|----------------------|
| 705512 | Inside Control Handle Kit with Washer and Rr Box Handle | link |

715130



| PART # | DESCRIPTION | LINK |
|--------|--|----------------------|
| 715130 | Black Dipped Toggle Switch with Pigtails | link |

715131



| PART # | DESCRIPTION | LINK |
|--------|------------------------------------|----------------------|
| 715131 | On Off Toggle Switch With Pigtails | link |

705503



725010



| PART # | DESCRIPTION | LINK |
|--------|-------------|----------------------|
| 705503 | Washer | link |

| PART # | DESCRIPTION | LINK |
|--------|-------------|----------------------|
| 725010 | O-Ring | link |

799260

no image

no image

| PART # | DESCRIPTION | LINK |
|--------|--------------------------|----------------------|
| 799260 | Rear Control Box Placard | link |

799351

| PART # | DESCRIPTION | LINK |
|--------|---------------------------------|----------------------|
| 799351 | Rear Control Box 4 Hole Placard | link |

799353

no image

| PART # | DESCRIPTION | LINK |
|--------|---------------------------------|----------------------|
| 799353 | Rear Control Box 5 Hole Placard | link |

285145



| PART # | DESCRIPTION | LINK |
|--------|------------------------|----------------------|
| 285145 | Pump Cable Mount Short | link |

285151



750020



| PART # | DESCRIPTION | LINK |
|--------|------------------------------------|----------------------|
| 285151 | Control Valve Lever Arm - 4in Bent | link |

| PART # | DESCRIPTION | LINK |
|--------|---------------------------|----------------------|
| 750020 | Hyd Drum Control Cylinder | link |

705008

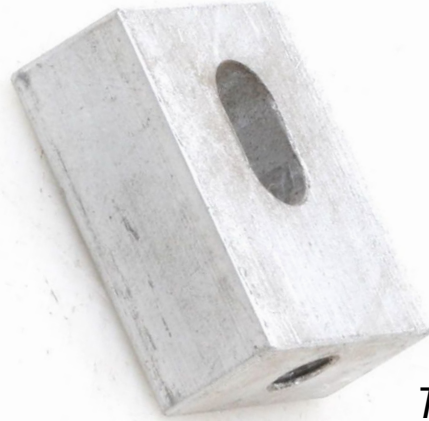

720060

| PART # | DESCRIPTION | LINK |
|--------|--------------------------------|----------------------|
| 705008 | 1/4in-28 Cable Clevis Assembly | link |

| PART # | DESCRIPTION | LINK |
|--------|--------------------|----------------------|
| 720060 | Cable Square Block | link |

705009



705010



| PART # | DESCRIPTION | LINK |
|--------|---------------------------------------|----------------------|
| 705009 | Concrete Mixer Cable Clevis Pin-1/4in | link |

| PART # | DESCRIPTION | LINK |
|--------|-----------------------------|----------------------|
| 705010 | 5/16in-24 Cable Clevis Yoke | link |

705011



| PART # | DESCRIPTION | LINK |
|--------|-------------|----------------------|
| 705011 | Clevis Pin | link |

705032



| PART # | DESCRIPTION | LINK |
|--------|--------------------------------------|----------------------|
| 705032 | Ball Joint - 5/16in Quick Disconnect | link |

705041



| PART # | DESCRIPTION | LINK |
|--------|--|----------------------|
| 705041 | Quick Release Ball Joint - 1/4in x 1/4in | link |

780100



| PART # | DESCRIPTION | LINK |
|--------|-------------|----------------------|
| 780100 | Stop Collar | link |

715525



| PART # | DESCRIPTION | LINK |
|--------|-----------------------|----------------------|
| 715525 | 25ft Pendant Assembly | link |

715530



| PART # | DESCRIPTION | LINK |
|--------|--------------------|----------------------|
| 715530 | Rear Mixer Pendant | link |

715535



799610



| PART # | DESCRIPTION | LINK |
|--------|-------------------------------------|----------------------|
| 715535 | 6 Function 12 Foot Pendant Assembly | link |

| PART # | DESCRIPTION | LINK |
|--------|---------------------|----------------------|
| 799610 | Rear Pendant Tester | link |

710011



715132



| PART # | DESCRIPTION | LINK |
|--------|-------------------------------------|----------------------|
| 710011 | Strain Relief with Flex Tail - 0.75 | link |

| PART # | DESCRIPTION | LINK |
|--------|------------------------------------|----------------------|
| 715132 | 3 Position Momentary Toggle Switch | link |

715133



715134

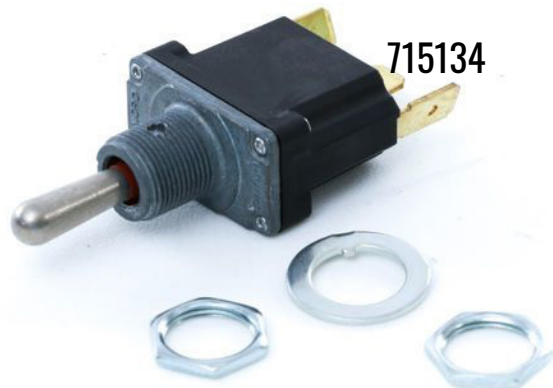

| PART # | DESCRIPTION | LINK |
|--------|-----------------------------|----------------------|
| 715133 | On Off Sealed Toggle Switch | link |

| PART # | DESCRIPTION | LINK |
|--------|---------------------|----------------------|
| 715134 | Toggle Switch Spade | link |

765006



799040



| PART # | DESCRIPTION | LINK |
|--------|-------------|------|
|--------|-------------|------|

765006 6 Function Remote Control Rear Pendant Housing [link](#)

| PART # | DESCRIPTION | LINK |
|--------|-------------|------|
|--------|-------------|------|

799040 Rear Remote Control 6 Function Face Plate [link](#)

730200



| PART # | DESCRIPTION | LINK |
|--------|-------------|------|
|--------|-------------|------|

730200 Black Full Toggle Switch Boot [link](#)

730201



| PART # | DESCRIPTION | LINK |
|--------|-------------|------|
|--------|-------------|------|

730201 Half Toggle Switch Boot with Black Guard [link](#)

215047



| PART # | DESCRIPTION | LINK |
|--------|-------------|------|
|--------|-------------|------|

215047 Pendant Holder Weldment [link](#)

2638



2640



| PART # | DESCRIPTION | LINK |
|--------|---------------|----------------------|
| 2638 | Rocker Switch | link |

| PART # | DESCRIPTION | LINK |
|--------|---------------|----------------------|
| 2640 | Rocker Switch | link |



| PART # | DESCRIPTION | LINK |
|--------|---------------|----------------------|
| 27197 | Control Cable | link |

| PART # | DESCRIPTION | LINK |
|--------|---------------|----------------------|
| 27198 | Control Cable | link |

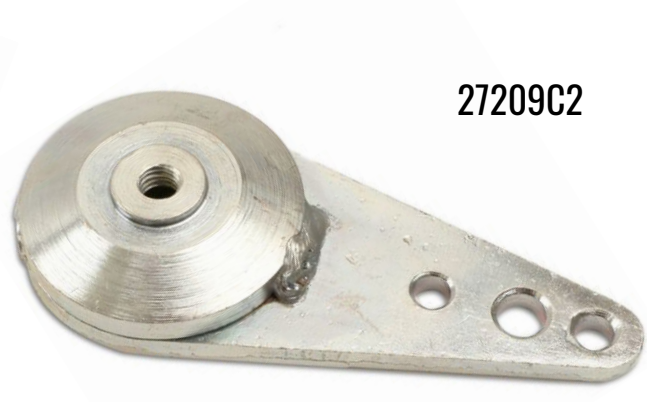

| PART # | DESCRIPTION | LINK |
|---------|------------------------|----------------------|
| 27209C1 | Rear Control Lever Arm | link |

| PART # | DESCRIPTION | LINK |
|---------|-----------------------------------|----------------------|
| 27209C2 | Throttle Rear Control Lever Plate | link |

27209C3



| PART # | DESCRIPTION | LINK |
|---------|--------------------------|----------------------|
| 27209C3 | Slotted Allen Head Screw | link |

2639



| PART # | DESCRIPTION | LINK |
|--------|---------------|----------------------|
| 2639 | Rocker Switch | link |

27209C4

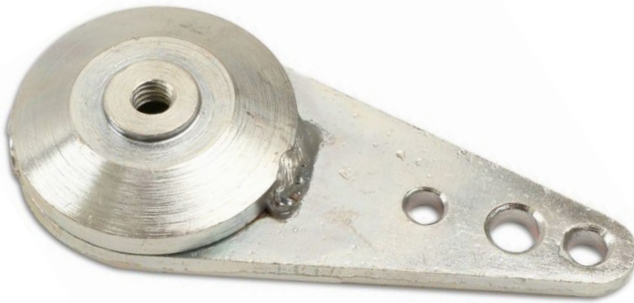

no image

| PART # | DESCRIPTION | LINK |
|---------|-------------------------------|----------------------|
| 27209C4 | Rear Control Drum Lever Plate | link |

29368

| PART # | DESCRIPTION | LINK |
|--------|-------------|----------------------|
| 29368 | Clevis Pin | link |

70918452



| PART # | DESCRIPTION | LINK |
|----------|-------------|----------------------|
| 70918452 | Cotter Pin | link |

51792



| PART # | DESCRIPTION | LINK |
|--------|--------------------------------------|----------------------|
| 51792 | Rear Remote Control Pendant Assembly | link |

6128



300221024



| PART # | DESCRIPTION | LINK |
|--------|-----------------------------|----------------------|
| 6128 | 2-Position Momentary Switch | link |

| PART # | DESCRIPTION | LINK |
|-----------|-------------|----------------------|
| 300221024 | Joystick | link |

300221001

no image



27209

| PART # | DESCRIPTION | LINK |
|-----------|---------------------|----------------------|
| 300221001 | Rear Pendant Keypad | link |

| PART # | DESCRIPTION | LINK |
|--------|------------------|----------------------|
| 27209 | Rear Control Box | link |



E933204110R

| PART # | DESCRIPTION | LINK |
|-------------|-----------------|----------------------|
| E933204110R | Control Pendant | link |

HH01022000

no image



| PART # | DESCRIPTION | LINK |
|------------|-----------------------|----------------------|
| HH01022000 | Air Throttle Cylinder | link |

MA30228



MM27257

| PART # | DESCRIPTION | LINK |
|---------|----------------------------|----------------------|
| MA30228 | Hydraulic Control Cylinder | link |

| PART # | DESCRIPTION | LINK |
|---------|-----------------------|----------------------|
| MM27257 | Control Handle O-Ring | link |

HH00356045



HH00294028



| PART # | DESCRIPTION | LINK |
|------------|--------------------------------------|----------------------|
| HH00356045 | Control Handle Socket Head Cap Screw | link |

| PART # | DESCRIPTION | LINK |
|------------|--------------------|----------------------|
| HH00294028 | Control Handle Hex | link |

MC38423

no image

MC40189



| PART # | DESCRIPTION | LINK |
|--------|-------------|------|
|--------|-------------|------|

MC38423 2 Switch Control Handle Housing [link](#)

| PART # | DESCRIPTION | LINK |
|--------|-------------|------|
|--------|-------------|------|

MC40189 Rear Control Pendant Yellow Handle Only [link](#)



HH00835003

| PART # | DESCRIPTION | LINK |
|--------|-------------|------|
|--------|-------------|------|

HH00835003 6 Wire Cable - 16 Gauge [link](#)



MA38422

| PART # | DESCRIPTION | LINK |
|--------|-------------|------|
|--------|-------------|------|

MA38422 2 Switch Control Handle Face Plate [link](#)



LM1040

| PART # | DESCRIPTION | LINK |
|--------|-------------|------|
|--------|-------------|------|

LM1040 Yellow Handle Pendant Remote - Double Switch with Cable [link](#)



MC4000005

| PART # | DESCRIPTION | LINK |
|--------|-------------|------|
|--------|-------------|------|

MC4000005 Yellow Remote Control Handle Assembly [link](#)



MC4000029

MC4000035



| PART # | DESCRIPTION | LINK |
|-----------|---------------------------------------|----------------------|
| MC4000029 | Yellow Remote Control Handle Assembly | link |

| PART # | DESCRIPTION | LINK |
|-----------|---------------------------------------|----------------------|
| MC4000035 | Yellow Remote Control Handle Assembly | link |



MC4000041



MTM4000041

| PART # | DESCRIPTION | LINK |
|-----------|--|----------------------|
| MC4000041 | 6 Switch Remote Control Pendant Assembly | link |

| PART # | DESCRIPTION | LINK |
|------------|--|----------------------|
| MTM4000041 | Pendant Assembly with Grey McNeilus Handle | link |

MC39741



| PART # | DESCRIPTION | LINK |
|---------|---------------------------------------|----------------------|
| MC39741 | Yellow Remote Control 6-Switch Handle | link |

MB3739



| PART # | DESCRIPTION | LINK |
|--------|---|----------------------|
| MB3739 | Right Side Axle Fender Mounting Bracket | link |

LONDON CONTROLS

HH01244012



MB39740



| PART # | DESCRIPTION | LINK |
|------------|---|----------------------|
| HH01244012 | Electrical Control Cable - 12 Wire 18 Gauge | link |

| PART # | DESCRIPTION | LINK |
|---------|-----------------------------------|----------------------|
| MB39740 | Control 6 Switch Faceplate Gasket | link |

HH01185005



HH00455007

| PART # | DESCRIPTION | LINK |
|------------|-------------------------|----------------------|
| HH01185005 | Control Reducer Bushing | link |

| PART # | DESCRIPTION | LINK |
|------------|---|----------------------|
| HH00455007 | Faceplate Screw for MC-40000-41 Control Pendant | link |



MA38416

MA26602



| PART # | DESCRIPTION | LINK |
|---------|------------------------|----------------------|
| MA38416 | Toggle Switch - Off/On | link |

| PART # | DESCRIPTION | LINK |
|---------|-----------------------------|----------------------|
| MA26602 | 2-Position Momentary Switch | link |

MM26603



MA39997



| PART # | DESCRIPTION | LINK |
|---------|--|----------------------|
| MM26603 | Half Toggle Switch Boot with Black Guard | link |

| PART # | DESCRIPTION | LINK |
|---------|--------------------------|----------------------|
| MA39997 | Control Handle Male Plug | link |

MA39999

NO PIC



HH01224012

| PART # | DESCRIPTION | LINK |
|---------|----------------------|----------------------|
| MA39999 | Control Handle Cover | link |

| PART # | DESCRIPTION | LINK |
|------------|----------------------------------|----------------------|
| HH01224012 | Control 1/2in Flex Strain Relief | link |

HH01246030



HH01224005



| PART # | DESCRIPTION | LINK |
|------------|-------------|----------------------|
| HH01246030 | Cord Grip | link |

| PART # | DESCRIPTION | LINK |
|------------|---------------------|----------------------|
| HH01224005 | 3/4in Strain Relief | link |

LONDON CONTROLS

MA39996

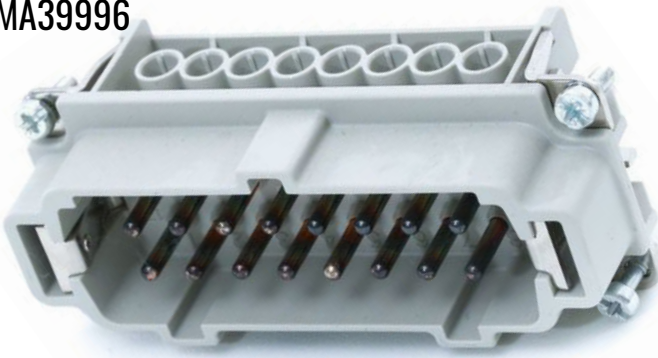

MA39998



| PART # | DESCRIPTION | LINK |
|---------|----------------------------------|----------------------|
| MA39996 | Control Handle Female Receptacle | link |

| PART # | DESCRIPTION | LINK |
|---------|---------------------------|----------------------|
| MA39998 | Control Handle Base Mount | link |

MA41464

NO PIC



| PART # | DESCRIPTION | LINK |
|---------|----------------------------------|----------------------|
| MA41464 | Remote Control Radio Transmitter | link |

MA42100

| PART # | DESCRIPTION | LINK |
|---------|------------------------------|----------------------|
| MA42100 | Omnex Receiver, R160, 2.4GHZ | link |

MA42101



| PART # | DESCRIPTION | LINK |
|---------|------------------------------------|----------------------|
| MA42101 | Omnex Rechargeable Cradle Assembly | link |

MB42065



| PART # | DESCRIPTION | LINK |
|---------|-------------------------------|----------------------|
| MB42065 | Omnex Radio Transmitter, T110 | link |

0153902



0153899



| PART # | DESCRIPTION | LINK |
|---------|---------------------------------|----------------------|
| 0153902 | Cab Control Box Housing - 11/96 | link |

| PART # | DESCRIPTION | LINK |
|---------|---------------------|----------------------|
| 0153899 | Rear Control O-Ring | link |



0153883

0110146

| PART # | DESCRIPTION | LINK |
|---------|-------------------------|----------------------|
| 0153883 | Rear Control Lever Shim | link |

| PART # | DESCRIPTION | LINK |
|---------|----------------------------|----------------------|
| 0110146 | Cab Control Lever Assembly | link |

0153895



0100661



| PART # | DESCRIPTION | LINK |
|---------|---------------------------|----------------------|
| 0153895 | Control Belleville Washer | link |

| PART # | DESCRIPTION | LINK |
|---------|--|----------------------|
| 0100661 | 5/16in-18 x 2in Slotted Allen Head Cap Screw | link |

MCNEILUS CONTROLS

0110147



0125833



| PART # | DESCRIPTION | LINK |
|---------|--------------------|----------------------|
| 0110147 | Cab Control Handle | link |

| PART # | DESCRIPTION | LINK |
|---------|----------------------------------|----------------------|
| 0125833 | 33ft of 4in Throw Throttle Cable | link |

0000800



0120476

| PART # | DESCRIPTION | LINK |
|---------|--------------------------------|----------------------|
| 0000800 | 1/4in-28 Cable Clevis Assembly | link |

| PART # | DESCRIPTION | LINK |
|---------|--|----------------------|
| 0120476 | Quick Release Ball Joint - 5/16in for Delta Remote | link |

0000801



0150926



| PART # | DESCRIPTION | LINK |
|---------|---------------------------------------|----------------------|
| 0000801 | Concrete Mixer Cable Clevis Pin-1/4in | link |

| PART # | DESCRIPTION | LINK |
|---------|------------------------|----------------------|
| 0150926 | Pump Cable Mount Short | link |

0500314



0819297



| PART # | DESCRIPTION | LINK |
|---------|------------------------------------|----------------------|
| 0500314 | Control Valve Lever Arm - 4in Bent | link |

| PART # | DESCRIPTION | LINK |
|---------|--|----------------------|
| 0819297 | Control Pendant 6 Switch Plastic Deutsch Connector-25 ft Cable | link |

1256494



0189310

| PART # | DESCRIPTION | LINK |
|---------|---|----------------------|
| 1256494 | Control Pendant 6 Switch with Plastic Deutsch Connector | link |

| PART # | DESCRIPTION | LINK |
|---------|----------------------|----------------------|
| 0189310 | 5ft Pendant Assembly | link |

1147124



0110234

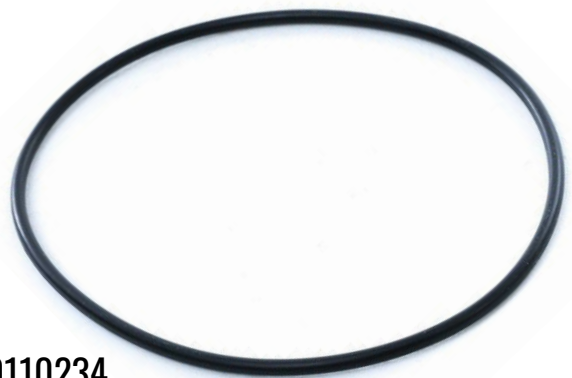

| PART # | DESCRIPTION | LINK |
|---------|-----------------------------------|----------------------|
| 1147124 | Control Pendant 3ft Cord 4 Toggle | link |

| PART # | DESCRIPTION | LINK |
|---------|------------------|----------------------|
| 0110234 | Buna N 70 O-Ring | link |

MCNEILUS CONTROLS

0110233



0110205



| PART # | DESCRIPTION | LINK |
|---------|--|----------------------|
| 0110233 | 6 Function Remote Control Rear Pendant Housing | link |

| PART # | DESCRIPTION | LINK |
|---------|-------------------------------------|----------------------|
| 0110205 | Strain Relief with Flex Tail - 0.75 | link |

1137068



0000694

| PART # | DESCRIPTION | LINK |
|---------|------------------------------------|----------------------|
| 1137068 | Electrical Wire 16/18 Cold Weather | link |

| PART # | DESCRIPTION | LINK |
|---------|-------------------------------------|----------------------|
| 0000694 | Electrical 16 Gauge x 18 Wire Cable | link |

1100961

no pic

1100322



| PART # | DESCRIPTION | LINK |
|---------|--|----------------------|
| 1100961 | Grey Boot for Deutsch Connector on Pendant | link |

| PART # | DESCRIPTION | LINK |
|---------|------------------------------|----------------------|
| 1100322 | Deutsch 23 Pin Female Socket | link |

0189136



0128730



| PART # | DESCRIPTION | LINK |
|---------|------------------------------------|----------------------|
| 0189136 | 3 Position Momentary Toggle Switch | link |

| PART # | DESCRIPTION | LINK |
|---------|-----------------------|----------------------|
| 0128730 | On/ Off Toggle Switch | link |

0123001

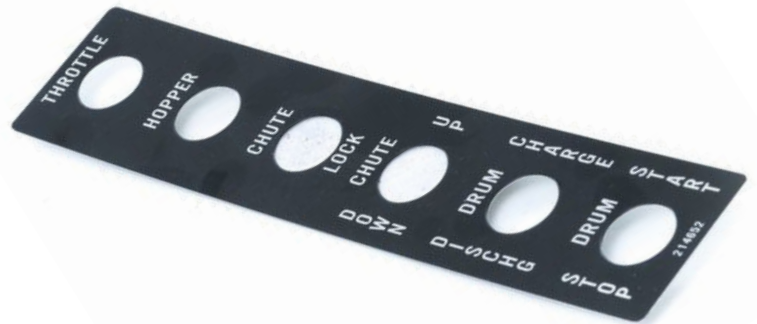

| PART # | DESCRIPTION | LINK |
|---------|---------------------------------------|----------------------|
| 0123001 | Panel Washer Seal for Toggle Switches | link |

| PART # | DESCRIPTION | LINK |
|---------|---|----------------------|
| 0214652 | Rear Remote Control 6 Function Face Plate | link |

0110194



1183133



| PART # | DESCRIPTION | LINK |
|---------|--|----------------------|
| 0110194 | Half Toggle Switch Boot with Black Guard | link |

| PART # | DESCRIPTION | LINK |
|---------|-------------------------|----------------------|
| 1183133 | HDP20 Panel Nut Size 24 | link |

MCNEILUS CONTROLS

0153880



0153914



| PART # | DESCRIPTION | LINK |
|---------|-----------------------------|----------------------|
| 0153880 | Two Handle Rear Control Box | link |

| PART # | DESCRIPTION | LINK |
|---------|---|----------------------|
| 0153914 | Single Handle Rear Control Box for Throttle | link |

0153890



0153898

| PART # | DESCRIPTION | LINK |
|---------|---------------------------------|----------------------|
| 0153890 | Control Box Housing for 0153880 | link |

| PART # | DESCRIPTION | LINK |
|---------|----------------------------|----------------------|
| 0153898 | Rear Control Box Lever Arm | link |

0016552



0016553



| PART # | DESCRIPTION | LINK |
|---------|-----------------------------|----------------------|
| 0016552 | Rear Control Knob Kit-Green | link |

| PART # | DESCRIPTION | LINK |
|---------|---------------------------|----------------------|
| 0016553 | Rear Control Knob Kit-Red | link |

0153888



0153889



| PART # | DESCRIPTION | LINK |
|---------|---------------------------------|----------------------|
| 0153888 | Rear Control Lever Plate - Drum | link |

| PART # | DESCRIPTION | LINK |
|---------|-------------------------------------|----------------------|
| 0153889 | Rear Control Lever Plate - Throttle | link |

0215077

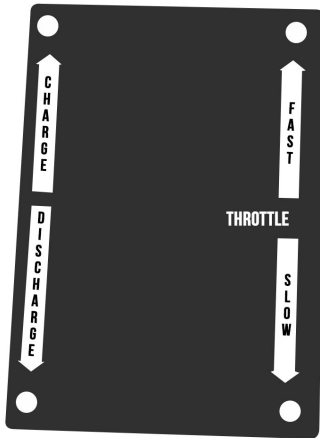

0214659

| PART # | DESCRIPTION | LINK |
|---------|--------------------------|----------------------|
| 0215077 | Rear Control Box Placard | link |

| PART # | DESCRIPTION | LINK |
|---------|--------------------------------|----------------------|
| 0214659 | Charge-Discharge Lever Placard | link |

0129701

no pic

0214662

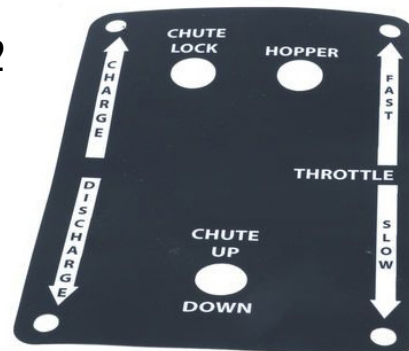

| PART # | DESCRIPTION | LINK |
|---------|--|----------------------|
| 0129701 | Drum, Chute Lock, Chute Lift, Throttle Placard | link |

| PART # | DESCRIPTION | LINK |
|---------|---|----------------------|
| 0214662 | Rear Control Box Placard Plate With 3 Holes | link |

MCNEILUS CONTROLS

0085693



1166275



| PART # | DESCRIPTION | LINK |
|---------|---|----------------------|
| 0085693 | Black Dipped Toggle Switch with Pigtailed | link |

| PART # | DESCRIPTION | LINK |
|---------|-------------------------------------|----------------------|
| 1166275 | On Off Toggle Switch With Pigtailed | link |

0110194



0115163

| PART # | DESCRIPTION | LINK |
|---------|--|----------------------|
| 0110194 | Half Toggle Switch Boot with Black Guard | link |

| PART # | DESCRIPTION | LINK |
|---------|--|----------------------|
| 0115163 | 3/4in Inner Diameter Push-in Flexible Rubber Grommet | link |

0115953



1489929



| PART # | DESCRIPTION | LINK |
|---------|---|----------------------|
| 0115953 | Push-in Metal Plug 1in for 115914 Control Box | link |

| PART # | DESCRIPTION | LINK |
|---------|------------------------------|----------------------|
| 1489929 | Rear Control Pendant Bracket | link |

1499607



30389023



| PART # | DESCRIPTION | LINK |
|---------|--|----------------------|
| 1499607 | Key Pad Rear Pendant Wrap Weldment Bracket | link |

| PART # | DESCRIPTION | LINK |
|----------|-------------|----------------------|
| 30389023 | Washer | link |



30389014

| PART # | DESCRIPTION | LINK |
|----------|-------------------------|----------------------|
| 30389014 | Rear Control Lever Shim | link |



30389013

| PART # | DESCRIPTION | LINK |
|----------|--|----------------------|
| 30389013 | Red Rear Control Charge-Discharge Knob Kit | link |

30389246



| PART # | DESCRIPTION | LINK |
|----------|--------------------|----------------------|
| 30389246 | Cab Control Handle | link |

30389247

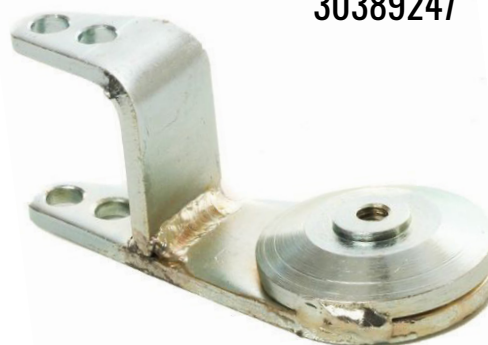

| PART # | DESCRIPTION | LINK |
|----------|----------------------------|----------------------|
| 30389247 | Cab Control Lever Assembly | link |

SCHWING CONTROLS

30389018



| PART # | DESCRIPTION | LINK |
|----------|------------------------|----------------------|
| 30389018 | Rear Control Lever Arm | link |

30341455



| PART # | DESCRIPTION | LINK |
|----------|---------------------------------|----------------------|
| 30341455 | Operators Toggle Switch - On On | link |

30389310

no pic



| PART # | DESCRIPTION | LINK |
|----------|---------------------------------|----------------------|
| 30389310 | Rear Control Box 5 Hole Placard | link |

30341452

| PART # | DESCRIPTION | LINK |
|----------|-----------------------------|----------------------|
| 30341452 | Electric Toggle Switch Seal | link |

30389024



| PART # | DESCRIPTION | LINK |
|----------|------------------|----------------------|
| 30389024 | Rear Control Box | link |

30389315



| PART # | DESCRIPTION | LINK |
|----------|---|----------------------|
| 30389315 | Ball Joint - 1/4in x 1/4in Cable Ball Joint | link |

30361593



| PART # | DESCRIPTION | LINK |
|--------|-------------|------|
|--------|-------------|------|

30361593 Pivot Bushing Bracket, [link](#)
Booster

30368750



| PART # | DESCRIPTION | LINK |
|--------|-------------|------|
|--------|-------------|------|

30368750 Yellow Remote Enclosure [link](#)
Pendant Housing Kit

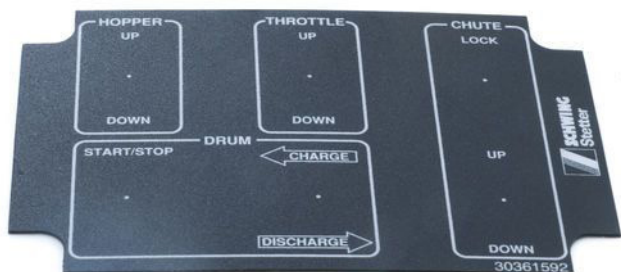

30361592

| PART # | DESCRIPTION | LINK |
|--------|-------------|------|
|--------|-------------|------|

30361592 Mixer Cable Remote Box [link](#)
Decal

30324217



| PART # | DESCRIPTION | LINK |
|--------|-------------|------|
|--------|-------------|------|

30264217 2-Position Momentary [link](#)
Switch



30315770

| PART # | DESCRIPTION | LINK |
|--------|-------------|------|
|--------|-------------|------|

30315770 Single Pole Operation [link](#)
Toggle Switch

30346498



| PART # | DESCRIPTION | LINK |
|--------|-------------|------|
|--------|-------------|------|

30346498 18-22 Gauge Terminal [link](#)
Ring #10

SCHWING CONTROLS

10013424



10022656

| PART # | DESCRIPTION | LINK |
|----------|--------------------------|----------------------|
| 10013424 | Pendant Crimp Pin-Female | link |

| PART # | DESCRIPTION | LINK |
|----------|------------------------|----------------------|
| 10022656 | Pendant Crimp Pin-Male | link |

303615936



3036159310



| PART # | DESCRIPTION | LINK |
|-----------|--|----------------------|
| 303615936 | Control Pendant Assembly with 6ft Cord | link |

| PART # | DESCRIPTION | LINK |
|------------|---|----------------------|
| 3036159310 | Control Pendant Assembly with 10ft Cord | link |

30342973



30342970



| PART # | DESCRIPTION | LINK |
|----------|-----------------------|----------------------|
| 30342973 | Male Contact Terminal | link |

| PART # | DESCRIPTION | LINK |
|----------|------------------|----------------------|
| 30342970 | Green Cable Seal | link |

30353758



30389114

| PART # | DESCRIPTION | LINK |
|--------|-------------|------|
|--------|-------------|------|

| PART # | DESCRIPTION | LINK |
|--------|-------------|------|
|--------|-------------|------|

30353758 Weather-Pack [link](#)

30389114 14-20 Gauge Terminal Contact Pin [link](#)

30353752



10013608

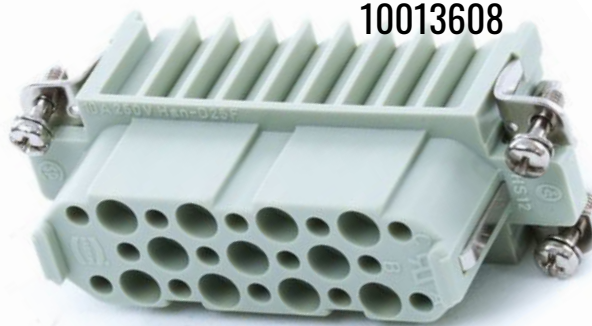

| PART # | DESCRIPTION | LINK |
|--------|-------------|------|
|--------|-------------|------|

| PART # | DESCRIPTION | LINK |
|--------|-------------|------|
|--------|-------------|------|

30353752 Female Crimp Pin for 30361593 Remote Control Pendant [link](#)

10013608 25 Pole + PE Socket Insert for 30361593 Remote Control Pendant [link](#)

30361750



30389104



| PART # | DESCRIPTION | LINK |
|--------|-------------|------|
|--------|-------------|------|

| PART # | DESCRIPTION | LINK |
|--------|-------------|------|
|--------|-------------|------|

30361750 Remote Control Pendant Connector Female Housing [link](#)

30389104 Remote Control Harness [link](#)

71090



71090A

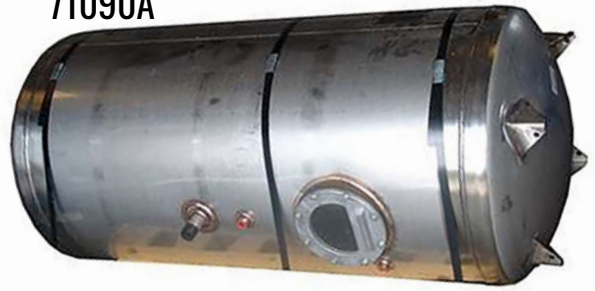

Compatible with [Con-Tech 285798](#)

| PART # | DESCRIPTION | LINK |
|--------|----------------------------|----------------------|
| 71090 | 90 Gallon Steel Water Tank | link |

| PART # | DESCRIPTION | LINK |
|--------|-------------------------------|----------------------|
| 71090A | 90 Gallon Aluminum Water Tank | link |

71000



71225A

| PART # | DESCRIPTION | LINK |
|--------|---|----------------------|
| 71000 | 125 Gallon Side Mount Water Tank Assembly | link |

| PART # | DESCRIPTION | LINK |
|--------|--|----------------------|
| 71225A | 125 Gallon Aluminum Universal Water Tank | link |

71100



71150A



| PART # | DESCRIPTION | LINK |
|--------|---------------------------------------|----------------------|
| 71100 | 150 Gallon Universal Steel Water Tank | link |

| PART # | DESCRIPTION | LINK |
|--------|--|----------------------|
| 71150A | 150 Gallon Universal Aluminum Water Tank | link |

71001

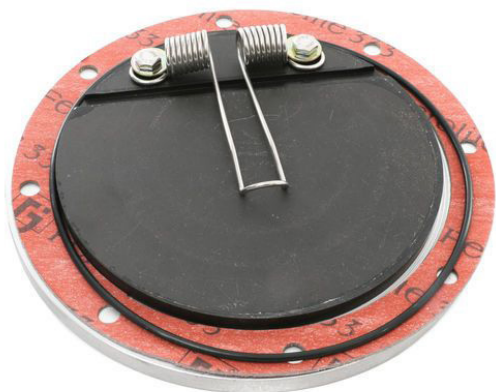

71010A



| PART # | DESCRIPTION | LINK |
|--------|------------------------------------|----------------------|
| 71001 | 6.75in Water Tank Flapper Assembly | link |

| PART # | DESCRIPTION | LINK |
|--------|--------------------------|----------------------|
| 71010A | Water Tank Flopper Cover | link |

71012



71018

| PART # | DESCRIPTION | LINK |
|--------|--------------------------------------|----------------------|
| 71012 | Water Tank Flapper Valve Rubber Seal | link |

| PART # | DESCRIPTION | LINK |
|--------|---------------------------|----------------------|
| 71018 | Water Tank Flapper Spring | link |

71002



72000

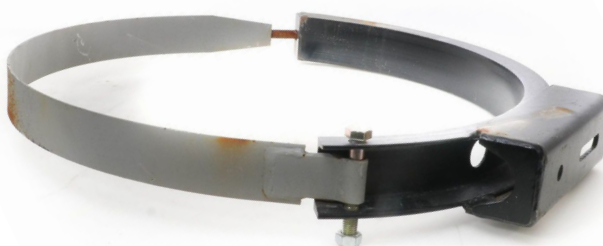

| PART # | DESCRIPTION | LINK |
|--------|--------------------------------------|----------------------|
| 71002 | Water Tank Flapper Gasket For 150830 | link |

| PART # | DESCRIPTION | LINK |
|--------|---------------------------------------|----------------------|
| 72000 | Water Tank Bracket and Strap Assembly | link |



72360

no pic

| PART # | DESCRIPTION | LINK |
|--------|--------------------------------|----------------------|
| 72350 | 3in Tank Strap Rubber Isolator | link |

| PART # | DESCRIPTION | LINK |
|--------|-----------------------------------|----------------------|
| 72360 | 3.25in Tank Strap Rubber Isolator | link |

71011

no pic



| PART # | DESCRIPTION | LINK |
|--------|----------------------------|----------------------|
| 71011 | Water Tank Handle Weldment | link |

| PART # | DESCRIPTION | LINK |
|--------|---------------------------------|----------------------|
| 70125 | 125 Gallon Water Gauge Assembly | link |

70004



70012



| PART # | DESCRIPTION | LINK |
|--------|-----------------------------------|----------------------|
| 70004 | 125 Gallon Water Tank Sight Strip | link |

| PART # | DESCRIPTION | LINK |
|--------|-----------------------------------|----------------------|
| 70012 | 150 Gallon Water Tank Sight Strip | link |

70006

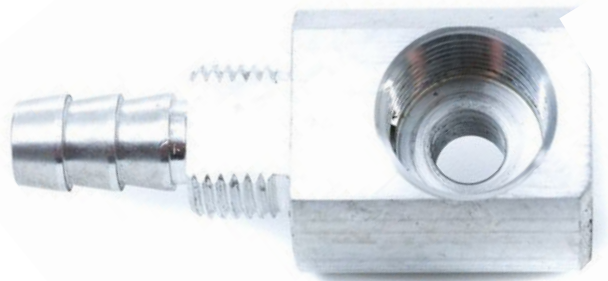

| PART # | DESCRIPTION | LINK |
|--------|------------------|----------------------|
| 70006 | Water Gauge Body | link |

70114



| PART # | DESCRIPTION | LINK |
|--------|---|----------------------|
| 70114 | Water Gauge Compression Fitting Adapter | link |



70115

| PART # | DESCRIPTION | LINK |
|--------|-----------------------------------|----------------------|
| 70115 | Water Gauge Adapter Delrin Sleeve | link |



700053

| PART # | DESCRIPTION | LINK |
|--------|--|----------------------|
| 700053 | 36in Acrylic Water Tank Sight Tube with Red Line | link |

70008



| PART # | DESCRIPTION | LINK |
|--------|-------------------------------|----------------------|
| 70008 | Red Floating Sight Gauge Ball | link |



70007

| PART # | DESCRIPTION | LINK |
|--------|-------------|----------------------|
| 70007 | Jam Nut | link |

1C416SS

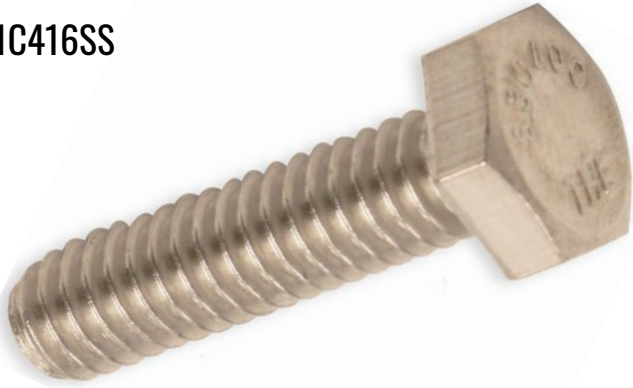

| PART # | DESCRIPTION | LINK |
|---------|-------------------------------------|----------------------|
| 1C416SS | Hex Head Cap Screw Bolt - Stainless | link |

1701



| PART # | DESCRIPTION | LINK |
|--------|--|----------------------|
| 1701 | Stainless Steel Nylon-Insert Hex Locknut | link |

1E04SS



| PART # | DESCRIPTION | LINK |
|--------|----------------------------------|----------------------|
| 1E04SS | 1/4in 316 Stainless Steel Washer | link |

70112



| PART # | DESCRIPTION | LINK |
|--------|-----------------|----------------------|
| 70112 | 3-Way Air Valve | link |

70011



| PART # | DESCRIPTION | LINK |
|--------|---------------|----------------------|
| 70011 | Brass Push In | link |

70118



| PART # | DESCRIPTION | LINK |
|--------|---|----------------------|
| 70118 | .25in Center Back Mount 2in Air Gauge 0-100 PSI | link |

70002

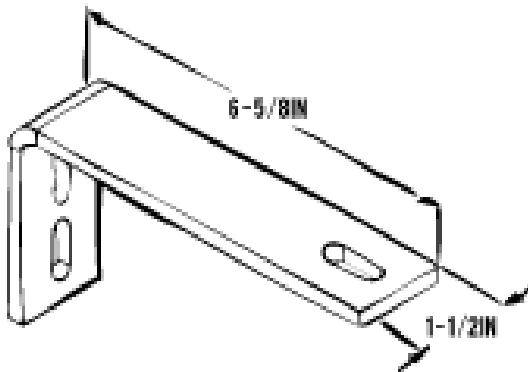

70116



| PART # | DESCRIPTION | LINK |
|--------|------------------------------|----------------------|
| 70002 | Water Tank Sight Gauge Mount | link |

| PART # | DESCRIPTION | LINK |
|--------|---------------------------------|----------------------|
| 70116 | Drain Cock Eternal Seat Petcock | link |

70215



70305

| PART # | DESCRIPTION | LINK |
|--------|---|----------------------|
| 70215 | 3-Way Air Pressure Valve Block Assembly | link |

| PART # | DESCRIPTION | LINK |
|--------|--------------------------------|----------------------|
| 70305 | Three-Way Water Tank Air Valve | link |

70300



70309

| PART # | DESCRIPTION | LINK |
|--------|----------------------|----------------------|
| 70300 | Water Gauge Assembly | link |

| PART # | DESCRIPTION | LINK |
|--------|-----------------------------|----------------------|
| 70309 | Gauge Box Assembly Manifold | link |



5PF08BV



5PF12BVA

| PART # | DESCRIPTION | LINK |
|----------|-------------------------------|----------------------|
| 5PF08BV | .5in Brass 2-Piece Ball Valve | link |
| 5PF08BVA | .5in Brass 2-Piece Ball Valve | link |

| PART # | DESCRIPTION | LINK |
|----------|------------------------|----------------------|
| 5PF12BV | .75in Brass Ball Valve | link |
| 5PF12BVA | .75in Brass Ball Valve | link |



5PF16BV



5PF20BV

| PART # | DESCRIPTION | LINK |
|----------|----------------|----------------------|
| 5PF16BV | 1in Ball Valve | link |
| 5PF16BVA | 1in Ball Valve | link |

| PART # | DESCRIPTION | LINK |
|----------|-------------|----------------------|
| 5PF20BV | Ball Valve | link |
| 5PF20BVA | Ball Valve | link |



5PF24BV



5FP16SR

| PART # | DESCRIPTION | LINK |
|---------|-------------|----------------------|
| 5PF24BV | Ball Valve | link |

| PART # | DESCRIPTION | LINK |
|---------|-------------|----------------------|
| 5FP16SR | Ball Valve | link |



74212

74225



| PART # | DESCRIPTION | LINK |
|--------|--|----------------------|
| 74212 | 12ft Washdown Water Hose with 5/8in Inner Diameter | link |

| PART # | DESCRIPTION | LINK |
|--------|--------------------------|----------------------|
| 74225 | 25ft Washdown Water Hose | link |



5HF1212



75000

| PART # | DESCRIPTION | LINK |
|---------|--------------|----------------------|
| 5HF1212 | Hose Adapter | link |

| PART # | DESCRIPTION | LINK |
|--------|-------------------------------------|----------------------|
| 75000 | Air Regulator - 0-125 psi 1/4in NPT | link |



75500

Compatible with [MFP 14R113FCL055](#)



73000

| PART # | DESCRIPTION | LINK |
|--------|---|----------------------|
| 75500 | Anti-Overfill Protection Air Regulator Preset at 55 PSI | link |

| PART # | DESCRIPTION | LINK |
|--------|---|----------------------|
| 73000 | Steel Water Line Tee Assembly 1in x 1in x 3/4in | link |

75600



75610



| PART # | DESCRIPTION | LINK |
|--------|------------------------------|----------------------|
| 75600 | Coalescing Filter Metal Bowl | link |

| PART # | DESCRIPTION | LINK |
|--------|------------------------------|----------------------|
| 75610 | Coalescing Filter Metal Bowl | link |



75615



76000

| PART # | DESCRIPTION | LINK |
|--------|---------------------------|----------------------|
| 75615 | Coalescing Filter Element | link |

| PART # | DESCRIPTION | LINK |
|--------|-------------------|----------------------|
| 76000 | Water Gauge Valve | link |

77000



73500



| PART # | DESCRIPTION | LINK |
|--------|-------------|----------------------|
| 77000 | Water Meter | link |

| PART # | DESCRIPTION | LINK |
|--------|--------------------|----------------------|
| 73500 | Water Tee Assembly | link |

78000



78100



| PART # | DESCRIPTION | LINK |
|--------|------------------------|----------------------|
| 78000 | 55psi Air Safety Valve | link |

| PART # | DESCRIPTION | LINK |
|--------|--|----------------------|
| 78100 | 1/2in Bronze Air Safety Relief Valve - 60PSI | link |

79320



93007I

| PART # | DESCRIPTION | LINK |
|--------|--|----------------------|
| 79320 | Water Injection Pipe with Mounting Bracket | link |

| PART # | DESCRIPTION | LINK |
|--------|----------------------------|----------------------|
| 93007I | Insulated Nozzle Poly Head | link |

79401



93007

| PART # | DESCRIPTION | LINK |
|--------|----------------------------|----------------------|
| 79401 | Long Water Injection Pipe | link |
| 79400 | Short Water Injection Pipe | link |

| PART # | DESCRIPTION | LINK |
|--------|----------------------------|----------------------|
| 93007 | Pistol Grip Washout Nozzle | link |

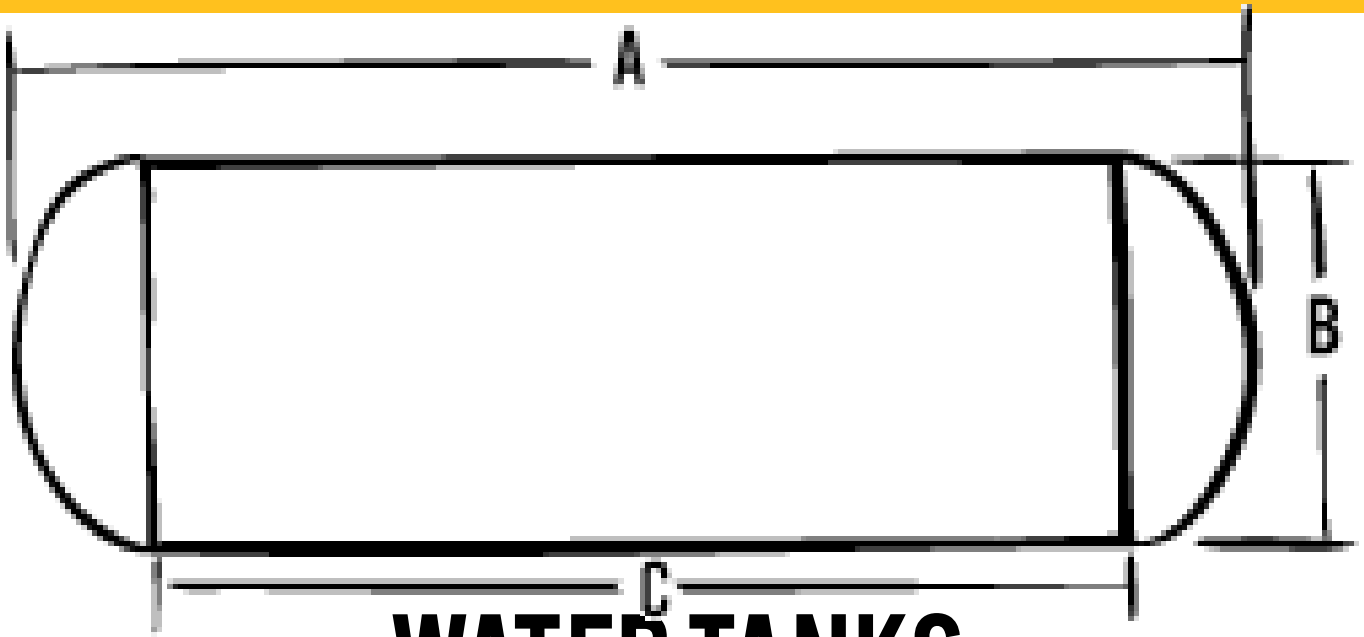

WATER TANKS

B = 24IN HEAD

90 Gallon: C = 39in / A = 49in

125 Gallon: C = 60in / A = 70in

150 Gallon: C = 72in / A = 82in

B = 26IN HEAD

100 Gallon: C = 40in / A = 48in

125 Gallon: C = 50in / A = 58in

150 Gallon: C = 61in / A = 69in

B = 30IN HEAD

200 Gallon: C = 60in / A = 70in

250 Gallon: C = 77in / A = 86in

B = 36IN HEAD

300 Gallon: C = 60in / A = 73in

285 Gallon: C = 80in / A = 93in

90117090



90117091

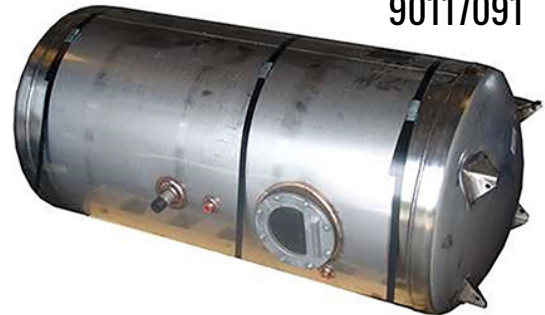

| PART # | DESCRIPTION | LINK | PART # | DESCRIPTION | LINK |
|----------|--|----------------------|----------|---|----------------------|
| 90117090 | 90 Gallon Steel Universal Mount Water Tank - 26in Head | link | 90117091 | 90 Gallon Aluminum Universal Mount Water Tank - 26in Head | link |

90117100



90117101



| PART # | DESCRIPTION | LINK |
|--------|-------------|------|
|--------|-------------|------|

| | | |
|----------|---|----------------------|
| 90117100 | 100 Gallon Steel Universal Mount Water Tank - 26in Head | link |
|----------|---|----------------------|

| PART # | DESCRIPTION | LINK |
|--------|-------------|------|
|--------|-------------|------|

| | | |
|----------|--|----------------------|
| 90117101 | 100 Gallon Aluminum Universal Mount Water Tank - 26in Head | link |
|----------|--|----------------------|

90117125



90117126



| PART # | DESCRIPTION | LINK |
|--------|-------------|------|
|--------|-------------|------|

| | | |
|----------|---|----------------------|
| 90117125 | 125 Gallon Steel Universal Mount Water Tank - 26in Head | link |
|----------|---|----------------------|

| PART # | DESCRIPTION | LINK |
|--------|-------------|------|
|--------|-------------|------|

| | | |
|----------|--|----------------------|
| 90117126 | 125 Gallon Aluminum Universal Mount Water Tank - 26in Head | link |
|----------|--|----------------------|

90117150



90117151



| PART # | DESCRIPTION | LINK |
|--------|-------------|------|
|--------|-------------|------|

| | | |
|----------|---|----------------------|
| 90117150 | 150 Gallon Steel Universal Mount Water Tank - 26in Head | link |
|----------|---|----------------------|

| PART # | DESCRIPTION | LINK |
|--------|-------------|------|
|--------|-------------|------|

| | | |
|----------|--|----------------------|
| 90117151 | 150 Gallon Aluminum Universal Mount Water Tank - 26in Head | link |
|----------|--|----------------------|

90110010



10110196



| PART # | DESCRIPTION | LINK |
|----------|------------------------------------|----------------------|
| 90110010 | 5in Flapper - Complete with Flange | link |

| PART # | DESCRIPTION | LINK |
|----------|-------------------------|----------------------|
| 10110196 | 5in Flapper - Seal Only | link |

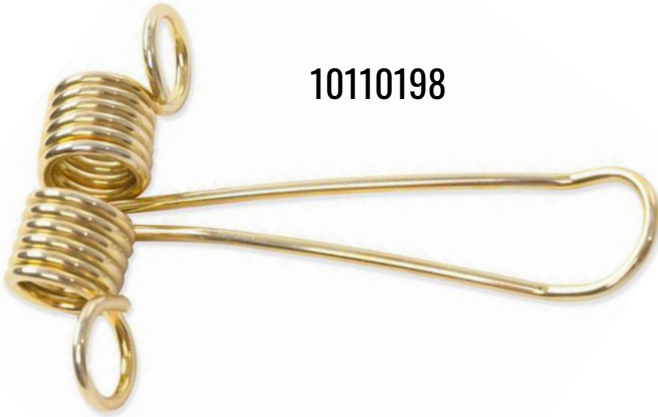

10110198

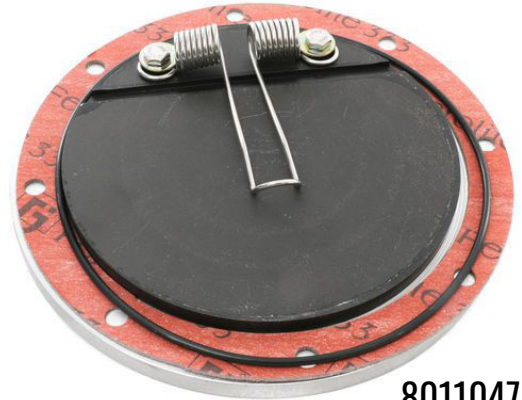

80110470

| PART # | DESCRIPTION | LINK |
|----------|-----------------------|----------------------|
| 10110198 | Double Torsion Spring | link |

| PART # | DESCRIPTION | LINK |
|----------|--|----------------------|
| 80110470 | 6.75in Kit - Includes Flapper, Spring, Flange, and Bolts** | link |

80110471



80110472



| PART # | DESCRIPTION | LINK |
|----------|--|----------------------|
| 80110471 | Double Torsion Spring for 80110470 Flapper | link |

| PART # | DESCRIPTION | LINK |
|----------|----------------------------|----------------------|
| 80110472 | 6.75in Flapper - Seal Only | link |

** Used on CBMW and MTM Tanks

80110473



80110475



| PART # | DESCRIPTION | LINK |
|----------|-------------------------|----------------------|
| 80110473 | Aluminum Flapper Flange | link |

| PART # | DESCRIPTION | LINK |
|----------|-----------------------|----------------------|
| 80110475 | Flange Flapper Gasket | link |

80110476

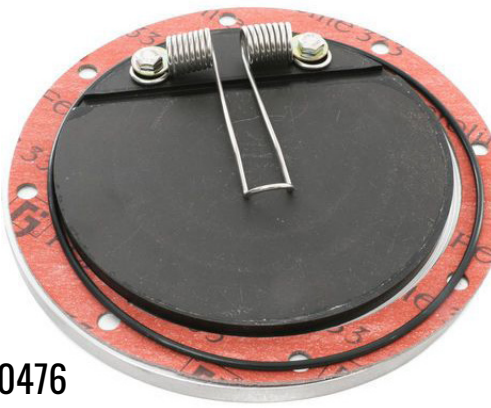

| PART # | DESCRIPTION | LINK |
|----------|--|----------------------|
| 80110476 | 6.75in Kit - Includes Flapper, Spring, Flange, and Bolts | link |

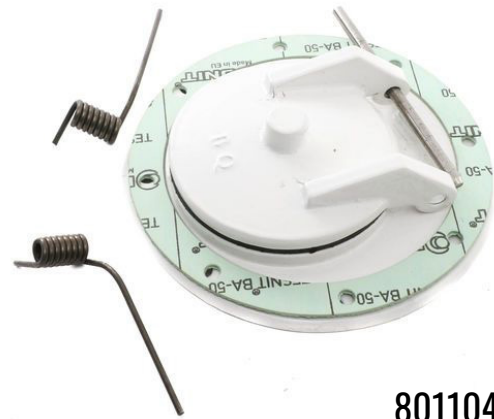

| PART # | DESCRIPTION | LINK |
|----------|-------------------------|----------------------|
| 80110420 | 4in Flapper Assembly*** | link |

80110404



| PART # | DESCRIPTION | LINK |
|----------|-------------------------|----------------------|
| 80110404 | 4in Flapper - Seal Only | link |

80110412



| PART # | DESCRIPTION | LINK |
|----------|----------------------|----------------------|
| 80110412 | Flapper Assembly Pin | link |

*** Used on MTM and London Tanks

10100165



10100166



| PART # | DESCRIPTION | LINK |
|----------|-------------------------------|----------------------|
| 10100165 | .5in Brass 2-Piece Ball Valve | link |

| PART # | DESCRIPTION | LINK |
|----------|---------------------------|----------------------|
| 10100166 | .75in Ball Valve | link |
| 10102166 | .75in Ball Valve - Apollo | link |

10100168

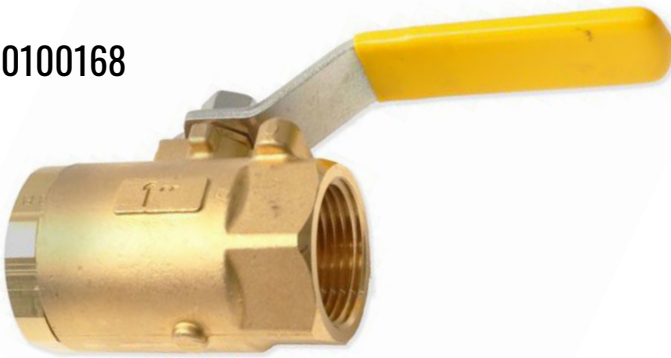

| PART # | DESCRIPTION | LINK |
|----------|-------------------------|----------------------|
| 10100168 | 1in Ball Valve | link |
| 10102168 | 1in Ball Valve - Apollo | link |

| PART # | DESCRIPTION | LINK |
|----------|-------------------|----------------------|
| 10100170 | 1.25in Ball Valve | link |

10100170

10100172



10100174

| PART # | DESCRIPTION | LINK |
|----------|------------------|----------------------|
| 10100172 | 1.5in Ball Valve | link |

| PART # | DESCRIPTION | LINK |
|----------|----------------|----------------------|
| 10100174 | 2in Ball Valve | link |

10101168



10100141



| PART # | DESCRIPTION | LINK |
|----------|---|----------------------|
| 10101168 | 1in Ball Valve with Deadman Auto Shut Off | link |

| PART # | DESCRIPTION | LINK |
|----------|----------------------------|----------------------|
| 10100141 | 60 PSI Safety Relief Valve | link |

10100143



| PART # | DESCRIPTION | LINK |
|----------|----------------------------|----------------------|
| 10100143 | 75 PSI Safety Relief Valve | link |

| PART # | DESCRIPTION | LINK |
|----------|----------------------------|----------------------|
| 10100150 | 55 PSI Safety Relief Valve | link |

10100150

80100466



| PART # | DESCRIPTION | LINK |
|----------|---|----------------------|
| 80100466 | .5in Bronze Air Safety Relief Valve - 60PSI | link |

| PART # | DESCRIPTION | LINK |
|----------|--------------------------------|----------------------|
| 10100163 | .25in Adjustable Air Regulator | link |

CONTINENTAL WATER SYSTEMS

10100167



10100835



| PART # | DESCRIPTION | LINK |
|----------|---|----------------------|
| 10100167 | 1in Adjustable Air Regulator - 5 to 125 PSI | link |

| PART # | DESCRIPTION | LINK |
|----------|---------------------------------|----------------------|
| 10100835 | 50 PSI Non-Adjustable Regulator | link |

10100146



10100147



| PART # | DESCRIPTION | LINK |
|----------|--|----------------------|
| 10100146 | .25in Bottom Mount 2in Air Gauge 0-100 PSI | link |

| PART # | DESCRIPTION | LINK |
|----------|---|----------------------|
| 10100147 | .25in Center Back Mount 2in Air Gauge 0-100 PSI | link |

10100945



10130158

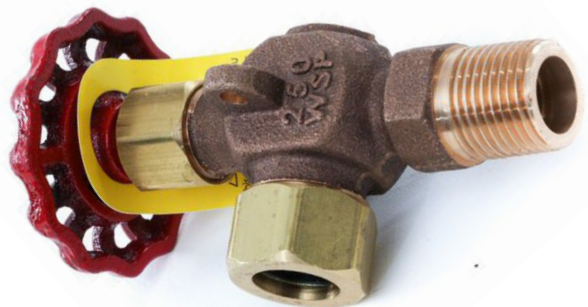

| PART # | DESCRIPTION | LINK |
|----------|--|----------------------|
| 10100945 | 2in Face 0-160 PSI 1/4in Center Back Mount | link |

| PART # | DESCRIPTION | LINK |
|----------|----------------------|----------------------|
| 10130158 | Top Gauge Body Gauge | link |

10130159

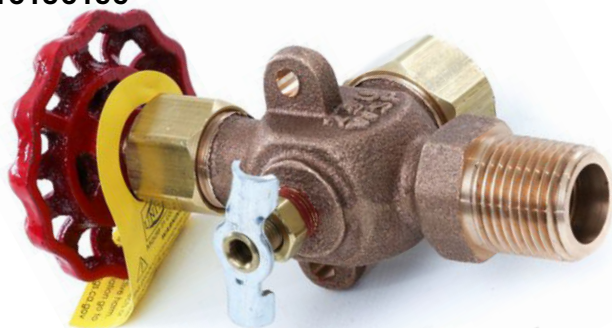

| PART # | DESCRIPTION | LINK |
|----------|-------------------------|----------------------|
| 10130159 | Bottom Gauge Body Gauge | link |



80100160

| PART # | DESCRIPTION | LINK |
|----------|---|----------------------|
| 80100160 | .5in Water Shut Off MTM Replacement Gauge | link |

90132001



| PART # | DESCRIPTION | LINK |
|----------|------------------------------------|----------------------|
| 90132001 | 90 Degree Sight Tube Adapter Elbow | link |



90132008

| PART # | DESCRIPTION | LINK |
|----------|---------------------------------------|----------------------|
| 90132008 | 3/8in Water Gauge Body Shut Off Valve | link |

10100152



| PART # | DESCRIPTION | LINK |
|----------|----------------------------------|----------------------|
| 10100152 | 3-Way Air Valve with 3/8in Ports | link |



10100154

| PART # | DESCRIPTION | LINK |
|----------|----------------------------------|----------------------|
| 10100154 | 3-Way Air Valve with .25in Ports | link |

90131026



| PART # | DESCRIPTION | LINK |
|----------|---|----------------------|
| 90131026 | 100 Gallon/ 378 Liter 26in Head Water Gauge Strip | link |

90131226



| PART # | DESCRIPTION | LINK |
|----------|---|----------------------|
| 90131226 | 125 Gallon/ 473 Liter 26in Head Water Gauge Strip | link |

90131526



| PART # | DESCRIPTION | LINK |
|----------|---|----------------------|
| 90131526 | 150 Gallon/ 567 Liter 26in Head Water Gauge Strip | link |

285798



285717



| PART # | DESCRIPTION | LINK |
|--------|-------------------------------|----------------------|
| 285798 | 90 Gallon Aluminum Water Tank | link |

| PART # | DESCRIPTION | LINK |
|--------|----------------------------|----------------------|
| 285609 | 90 Gallon Steel Water Tank | link |

| | | |
|--------|-------------------------------|----------------------|
| 285779 | 65 Gallon Aluminum Water Tank | link |
|--------|-------------------------------|----------------------|

| | | |
|--------|-----------------------------|----------------------|
| 285717 | 100 Gallon Steel Water Tank | link |
|--------|-----------------------------|----------------------|

285796



285528

| PART # | DESCRIPTION | LINK |
|--------|--------------------------------|----------------------|
| 285796 | 100 Gallon Aluminum Water Tank | link |

| PART # | DESCRIPTION | LINK |
|--------|--------------------------------|----------------------|
| 285528 | 125 Gallon Aluminum Water Tank | link |

285630



285637



| PART # | DESCRIPTION | LINK |
|--------|--|----------------------|
| 285630 | 125 Gallon Steel Side Mount Water Tank | link |

| PART # | DESCRIPTION | LINK |
|--------|--------------------------------|----------------------|
| 285637 | 150 Gallon Aluminum Water Tank | link |

285635



285794



| PART # | DESCRIPTION | LINK |
|--------|-----------------------------|----------------------|
| 285635 | 150 Gallon Steel Water Tank | link |

| PART # | DESCRIPTION | LINK |
|--------|--------------------------------|----------------------|
| 285794 | 200 Gallon Aluminum Water Tank | link |



285685

285743

| PART # | DESCRIPTION | LINK |
|--------|-----------------------------|----------------------|
| 285685 | 200 Gallon Steel Water Tank | link |

| PART # | DESCRIPTION | LINK |
|--------|-----------------------------|----------------------|
| 285743 | 300 Gallon Steel Water Tank | link |

285308



730048



| PART # | DESCRIPTION | LINK |
|--------|--|----------------------|
| 285308 | Water Tank Cross Mount Strap for 26in Diameter Tanks | link |

| PART # | DESCRIPTION | LINK |
|--------|--------------------|----------------------|
| 730005 | 2in Rubber Strap | link |
| 730011 | 2.5in Rubber Strap | link |
| 730048 | 3in Rubber Strap | link |

285084

no pic

285038



| PART # | DESCRIPTION | LINK |
|--------|----------------------------|----------------------|
| 285084 | Water Tank Handle Weldment | link |

| PART # | DESCRIPTION | LINK |
|--------|---------------------|----------------------|
| 285038 | Sight Gauge Bracket | link |

285021

no pic



710002

| PART # | DESCRIPTION | LINK |
|--------|------------------------------|----------------------|
| 285021 | Water Tank Sight Gauge Mount | link |

| PART # | DESCRIPTION | LINK |
|--------|------------------|----------------------|
| 710002 | Water Gauge Body | link |

730029

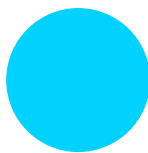

705013



| PART # | DESCRIPTION | LINK |
|--------|---|----------------------|
| 730029 | Water Tank Sight Gauge Blue Floating Ball for Mixer Site Glass Tube | link |

| PART # | DESCRIPTION | LINK |
|--------|------------------------------------|----------------------|
| 705013 | 3/4-16 Grade 2 Sight Glass Jam Nut | link |

710010

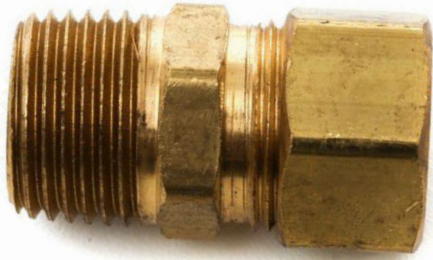

| PART # | DESCRIPTION | LINK |
|--------|---|----------------------|
| 710010 | Water Gauge Compression Fitting Adapter | link |

710008

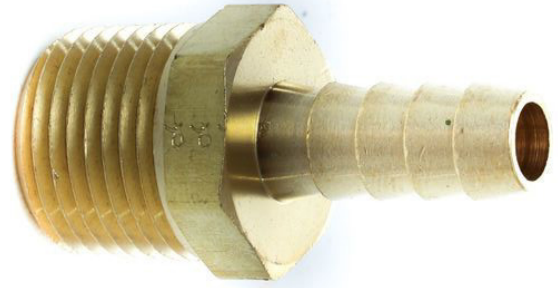

| PART # | DESCRIPTION | LINK |
|--------|--------------------|----------------------|
| 710008 | Nipple - Push Lock | link |

710007



| PART # | DESCRIPTION | LINK |
|--------|------------------------------------|----------------------|
| 710007 | External Seat Drain Petcock .125in | link |

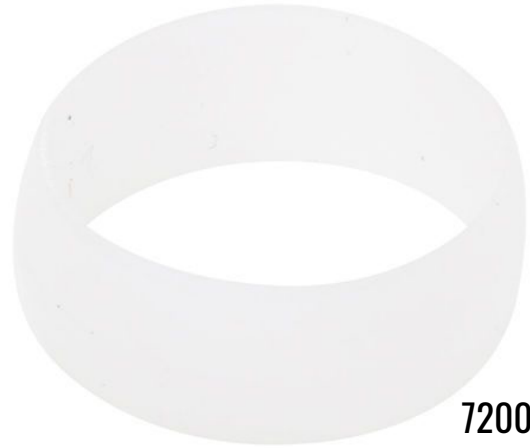

720012

| PART # | DESCRIPTION | LINK |
|--------|-----------------------------------|----------------------|
| 720012 | Water Gauge Adapter Delrin Sleeve | link |

730027

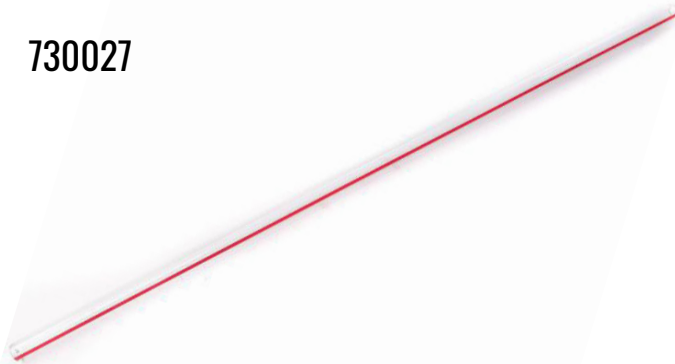

| PART # | DESCRIPTION | LINK |
|--------|------------------------------------|----------------------|
| 730027 | 28.5in Water Tank Sight Gauge Tube | link |

730028



| PART # | DESCRIPTION | LINK |
|--------|-------------------------------------|----------------------|
| 730028 | 72in Sight Gauge Tube with Red Line | link |

799003

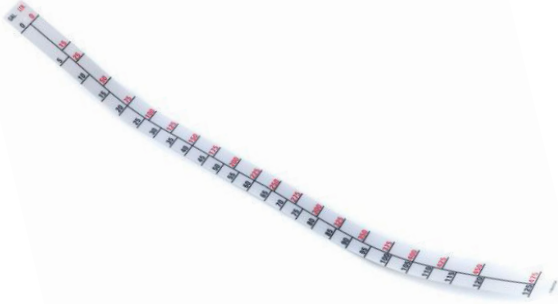

799017



| PART # | DESCRIPTION | LINK |
|--------|-----------------------------------|----------------------|
| 799003 | 125 Gallon Water Tank Sight Strip | link |

| PART # | DESCRIPTION | LINK |
|--------|-------------------------------------|----------------------|
| 799017 | 200 Gallon Gauge Strip - 30in Tanks | link |

799004



| PART # | DESCRIPTION | LINK |
|--------|-----------------------------------|----------------------|
| 799004 | 150 Gallon Water Tank Sight Strip | link |

799002

| PART # | DESCRIPTION | LINK |
|--------|---|----------------------|
| 799002 | Water Gauge Strip -100 Gallon X 26 Diameter | link |

760031



760021

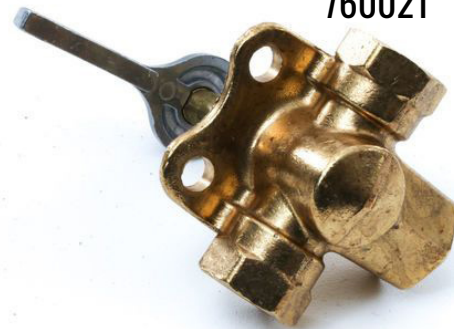

| PART # | DESCRIPTION | LINK |
|--------|---|----------------------|
| 760031 | Air Pressure 3-Way Valve Block Assembly | link |

| PART # | DESCRIPTION | LINK |
|--------|-----------------|----------------------|
| 760021 | 3-Way Air Valve | link |

760022



730025

no pic

| PART # | DESCRIPTION | LINK |
|--------|---|----------------------|
| 760022 | .25in Center Back Mount 2in Air Gauge 0-100 PSI | link |

| PART # | DESCRIPTION | LINK |
|--------|--|----------------------|
| 730025 | Push Lock Hose - Specify Length Per Foot | link |

730001

no pic

no pic

| PART # | DESCRIPTION | LINK |
|--------|-----------------------|----------------------|
| 730001 | 1in Rubber Water Hose | link |

| PART # | DESCRIPTION | LINK |
|--------|--------------------------|----------------------|
| 725080 | 8-5/8in Flapper Assembly | link |

725076



725009

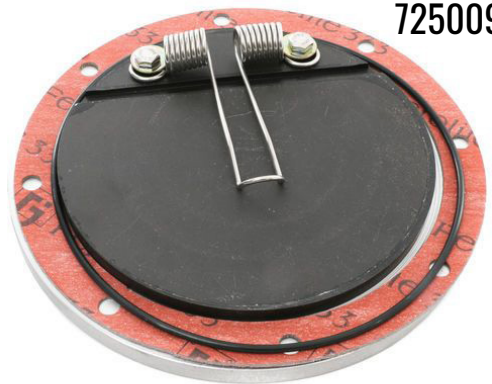

| PART # | DESCRIPTION | LINK |
|--------|------------------------|----------------------|
| 725076 | 8.625in Flapper Gasket | link |

| PART # | DESCRIPTION | LINK |
|--------|------------------------------------|----------------------|
| 725009 | 6.75in Water Tank Flapper Assembly | link |

285707



705020



| PART # | DESCRIPTION | LINK |
|--------|----------------|----------------------|
| 285707 | Flapper Flange | link |

| PART # | DESCRIPTION | LINK |
|--------|--|----------------------|
| 705020 | Water Tank Flapper Spring for 725009 Flopper | link |

730018



725011

| PART # | DESCRIPTION | LINK |
|--------|--------------------------------------|----------------------|
| 730018 | Water Tank Flapper Valve Rubber Seal | link |

| PART # | DESCRIPTION | LINK |
|--------|--------------------------------------|----------------------|
| 725011 | Water Tank Flapper Gasket For 725009 | link |

760030



760008



| PART # | DESCRIPTION | LINK |
|--------|--|----------------------|
| 760030 | 1/2in Bronze Air Safety Relief Valve - 60PSI | link |

| PART # | DESCRIPTION | LINK |
|--------|------------------------------------|----------------------|
| 760008 | Ball Valve - 1in NPT Spring Loaded | link |

CON-TECH WATER SYSTEMS

760091



| PART # | DESCRIPTION | LINK |
|--------|-------------|------|
|--------|-------------|------|

760091 Spring Loaded Valve with Drain Hole [link](#)

760003



| PART # | DESCRIPTION | LINK |
|--------|-------------|------|
|--------|-------------|------|

760003 1 Inch Brass Water Ball Valve with Stainless Steel Stem [link](#)

760018



| PART # | DESCRIPTION | LINK |
|--------|-------------|------|
|--------|-------------|------|

760018 .75in Ball Valve [link](#)

760036



| PART # | DESCRIPTION | LINK |
|--------|-------------|------|
|--------|-------------|------|

760036 .5in Ball Valve [link](#)

760059



| PART # | DESCRIPTION | LINK |
|--------|-------------|------|
|--------|-------------|------|

760059 1/2in FPT X MPT Brass Angle Ball Valve [link](#)

760079



| PART # | DESCRIPTION | LINK |
|--------|-------------|------|
|--------|-------------|------|

760079 3/4in Quick Release Valve [link](#)

760004



760020



| PART # | DESCRIPTION | LINK |
|--------|-------------------|----------------------|
| 760004 | Water Gauge Valve | link |

| PART # | DESCRIPTION | LINK |
|--------|--|----------------------|
| 760020 | Adjustable Air Regulator 0-60 PSI for Water Tanks | link |

760023



| PART # | DESCRIPTION | LINK |
|--------|--|----------------------|
| 760023 | 1/4in NPT Air Pressure Protection Valve | link |



| PART # | DESCRIPTION | LINK |
|--------|-------------------------|----------------------|
| 760076 | Miniature Air Regulator | link |

710004



| PART # | DESCRIPTION | LINK |
|--------|--|----------------------|
| 710004 | Fitting - 3/4 Male Truck Washdown Hose x 3/4 Male Pipe Adapter - Brass | link |

710009



| PART # | DESCRIPTION | LINK |
|--------|--|----------------------|
| 710009 | 1in Water Tank Nipple Hose Barb Fitting | link |

CON-TECH WATER SYSTEMS

600013



| PART # | DESCRIPTION | LINK |
|--------|-------------|------|
|--------|-------------|------|

600013 Water Valve Tee Assembly - Spring Loaded

[link](#)

710000



| PART # | DESCRIPTION | LINK |
|--------|-------------|------|
|--------|-------------|------|

710000 Steel Water Line Tee Assembly 1in x 1in x 3/4in

[link](#)



600000

| PART # | DESCRIPTION | LINK |
|--------|-------------|------|
|--------|-------------|------|

600000 Water Valve Tee Assembly

[link](#)



730070

| PART # | DESCRIPTION | LINK |
|--------|-------------|------|
|--------|-------------|------|

730070 Washdown Water Hose 5/8in ID x 10ft Long

[link](#)

730017



| PART # | DESCRIPTION | LINK |
|--------|-------------|------|
|--------|-------------|------|

730017 13ft Washdown Water Hose with 5/8in Inner Diameter

[link](#)

730009



| PART # | DESCRIPTION | LINK |
|--------|-------------|------|
|--------|-------------|------|

730009 25ft Washdown Water Hose

[link](#)

730071



730030



| PART # | DESCRIPTION | LINK |
|--------|--------------------------------------|----------------------|
| 730071 | 40ft Black Mixer Washdown Water Hose | link |

| PART # | DESCRIPTION | LINK |
|--------|----------------------------|----------------------|
| 730030 | Pistol Grip Washout Nozzle | link |

730034



no pic

| PART # | DESCRIPTION | LINK |
|--------|-----------------------------------|----------------------|
| 730034 | Insulated Water Hose Spray Nozzle | link |

730035

| PART # | DESCRIPTION | LINK |
|--------|----------------------------|----------------------|
| 730035 | Bend and Spray Hose Nozzle | link |

765201



| PART # | DESCRIPTION | LINK |
|--------|--------------------------------|----------------------|
| 765201 | Water Meter - 1in Electric GPI | link |

45896



| PART # | DESCRIPTION | LINK |
|--------|---------------------------|----------------------|
| 45896 | Water Tank Flapper Gasket | link |

18781



| PART # | DESCRIPTION | LINK |
|--------|------------------------------|----------------------|
| 18781 | 60in Water Tank Rubber Strap | link |

18786



| PART # | DESCRIPTION | LINK |
|--------|---------------------------|----------------------|
| 18786 | Water Tank Flapper Spring | link |

18842



| PART # | DESCRIPTION | LINK |
|--------|-------------|----------------------|
| 18842 | Sight Tube | link |

19357



| PART # | DESCRIPTION | LINK |
|--------|--|----------------------|
| 19357 | Water Tank Flapper Valve Rubber Flopper Seal | link |

19358



| PART # | DESCRIPTION | LINK |
|--------|--------------------------|----------------------|
| 19358 | Water Tank Flapper Plate | link |

29731



21184



| PART # | DESCRIPTION | LINK |
|--------|-----------------------------|----------------------|
| 29731 | 150 Gallon Steel Water Tank | link |

| PART # | DESCRIPTION | LINK |
|--------|--------------------------|----------------------|
| 21184 | Upper Sight Tube Fitting | link |

21186

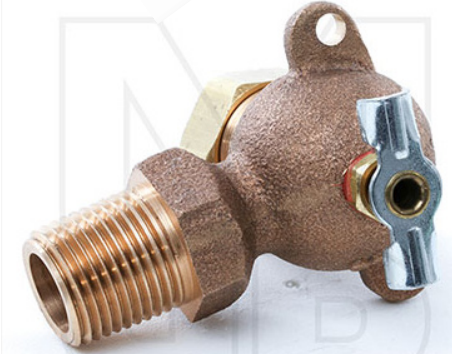

21187

| PART # | DESCRIPTION | LINK |
|--------|--------------------------|----------------------|
| 21186 | Sight Tube Petcock Valve | link |

| PART # | DESCRIPTION | LINK |
|--------|-----------------------|----------------------|
| 21187 | Sight Tube Drain Cock | link |

21185



21257



| PART # | DESCRIPTION | LINK |
|--------|-------------------------|----------------------|
| 21185 | Sight Tube Fiber Washer | link |

| PART # | DESCRIPTION | LINK |
|--------|------------------------------------|----------------------|
| 21257 | Rubber Washer for Sight Glass Tube | link |

HOUSBY WATER SYSTEMS

18765



| PART # | DESCRIPTION | LINK |
|--------|------------------------|----------------------|
| 18765 | Sight Glass Float Ball | link |

18870

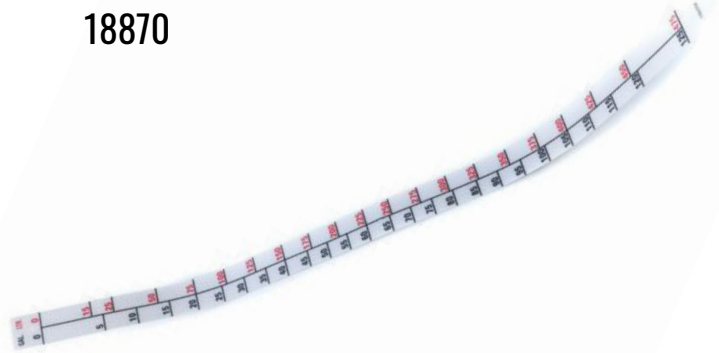

| PART # | DESCRIPTION | LINK |
|--------|-----------------------------------|----------------------|
| 18870 | 125 Gallon Water Tank Sight Strip | link |

18830

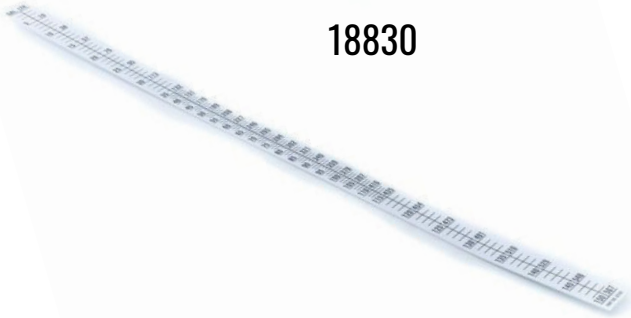

| PART # | DESCRIPTION | LINK |
|--------|-----------------------------------|----------------------|
| 18830 | 150 Gallon Water Tank Sight Strip | link |

10070



| PART # | DESCRIPTION | LINK |
|--------|--|----------------------|
| 10070 | 1/2in FPT X MPT Brass Angle Ball Valve | link |

13657



| PART # | DESCRIPTION | LINK |
|--------|--|----------------------|
| 13657 | Brass DOT Connector Compression 1/2Tube x 1/2MPT | link |

13721



| PART # | DESCRIPTION | LINK |
|--------|-------------------|----------------------|
| 13721 | Male Elbow Swivel | link |

18767



18768

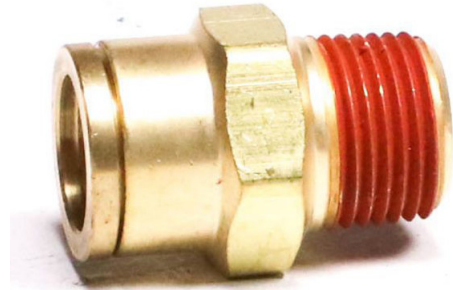

| PART # | DESCRIPTION | LINK |
|--------|--------------------|----------------------|
| 18767 | Sight Tube Fitting | link |

| PART # | DESCRIPTION | LINK |
|--------|----------------------------------|----------------------|
| 18768 | Brass DOT Connector Push Connect | link |

20065



| PART # | DESCRIPTION | LINK |
|--------|----------------------|----------------------|
| 20065 | Add Water Ball Valve | link |

| PART # | DESCRIPTION | LINK |
|--------|------------------|----------------------|
| 13653 | Air Brake Tubing | link |

13653

5597



3193



| PART # | DESCRIPTION | LINK |
|--------|-------------------|----------------------|
| 5597 | Sight Tube Washer | link |

| PART # | DESCRIPTION | LINK |
|--------|--------------------|----------------------|
| 3193 | Hose Formed Heater | link |

HOUSBY WATER SYSTEMS

18772



| PART # | DESCRIPTION | LINK |
|--------|------------------|----------------------|
| 18772 | .75in Ball Valve | link |

18773



| PART # | DESCRIPTION | LINK |
|--------|--------------|----------------------|
| 18773 | Hose Adapter | link |

18774



| PART # | DESCRIPTION | LINK |
|--------|--------------------------|----------------------|
| 18774 | 25ft Washdown Water Hose | link |



| PART # | DESCRIPTION | LINK |
|--------|---------------------|----------------------|
| 18775 | Washdown Water Hose | link |

18776



| PART # | DESCRIPTION | LINK |
|--------|----------------------------|----------------------|
| 18776 | Pistol Grip Washout Nozzle | link |

19354



| PART # | DESCRIPTION | LINK |
|--------|----------------|----------------------|
| 19354 | Water Manifold | link |

20030



28748



| PART # | DESCRIPTION | LINK |
|--------|-----------------------|----------------------|
| 20030 | 1in Bronze Y-Strainer | link |

| PART # | DESCRIPTION | LINK |
|--------|-------------|----------------------|
| 28748 | Water Meter | link |

7052



no pic

| PART # | DESCRIPTION | LINK |
|--------|------------------|----------------------|
| 7052 | Air Brake Tubing | link |

19079

| PART # | DESCRIPTION | LINK |
|--------|-----------------------|----------------------|
| 19079 | 255M Water Tank Strap | link |

KIMBLE WATER SYSTEMS

C940005000



C81W98BL00



| PART # | DESCRIPTION | LINK |
|------------|-------------|----------------------|
| C940005000 | Ball Valve | link |

| PART # | DESCRIPTION | LINK |
|------------|--------------------|----------------------|
| C81W98BL00 | Hose Formed Heater | link |



C81W050R13



C94N006200

| PART # | DESCRIPTION | LINK |
|------------|-------------------------------|----------------------|
| C81W050R13 | Washdown Hose - Red Hot Water | link |

| PART # | DESCRIPTION | LINK |
|------------|----------------------------|----------------------|
| C94N006200 | Pistol Grip Washout Nozzle | link |

C84J010000

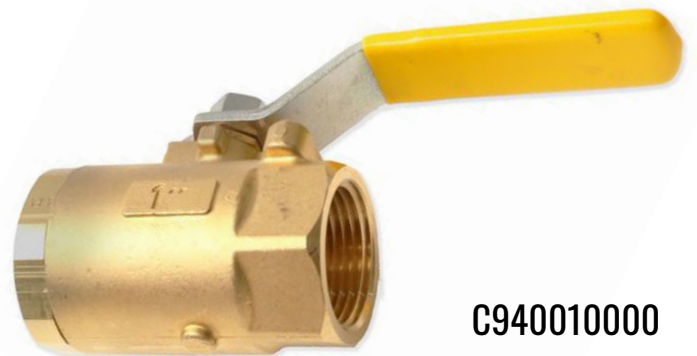

C940010000

| PART # | DESCRIPTION | LINK |
|------------|---|----------------------|
| C84J010000 | 1in Water Tank Nipple Hose Barb Fitting | link |

| PART # | DESCRIPTION | LINK |
|------------|----------------------------|----------------------|
| C940010000 | 1in Brass Water Ball Valve | link |

C84N010000



| PART # | DESCRIPTION | LINK |
|------------|--------------------|----------------------|
| C84N010000 | Schedule 40 Nipple | link |

C840409088



| PART # | DESCRIPTION | LINK |
|------------|----------------------|----------------------|
| C840409088 | Pipe Adapter - Brass | link |



C94F507500

| PART # | DESCRIPTION | LINK |
|------------|------------------|----------------------|
| C94F507500 | Water Ball Valve | link |

300202204

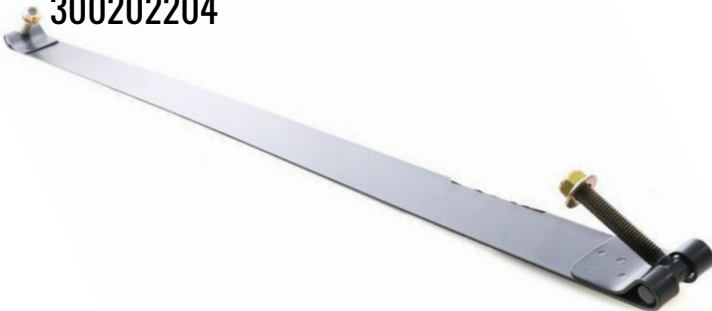

| PART # | DESCRIPTION | LINK |
|-----------|--|----------------------|
| 300202204 | 24in Diameter Cross Mount Water Tank Strap | link |

A130011100



| PART # | DESCRIPTION | LINK |
|------------|--|----------------------|
| A130011100 | 1/2in Bronze Air Safety Relief Valve - 60PSI | link |

KIMBLE WATER SYSTEMS



C94W001000

| PART # | DESCRIPTION | LINK |
|------------|----------------------------|----------------------|
| C94W001000 | .5in Water Gauge Valve Set | link |



C994402400

| PART # | DESCRIPTION | LINK |
|------------|-------------------------------------|----------------------|
| C994402400 | 72in Sight Gauge Tube with Red Line | link |



C990032300

| PART # | DESCRIPTION | LINK |
|------------|---|----------------------|
| C990032300 | Water Tank Sight Gauge Red Floating Ball for Mixer Sight Glass Tube | link |

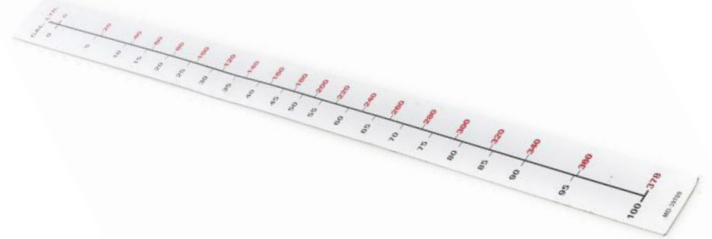

C950010024

| PART # | DESCRIPTION | LINK |
|------------|-------------|----------------------|
| C950010024 | Dual Scale | link |



C950015024

| PART # | DESCRIPTION | LINK |
|------------|-------------------|----------------------|
| C950015024 | Sight Gauge Strip | link |



S175083001

| PART # | DESCRIPTION | LINK |
|------------|--------------------|----------------------|
| S175083001 | Water Tank Flapper | link |

C950010021



200018008



| PART # | DESCRIPTION | LINK |
|------------|--|----------------------|
| C950010021 | Gauge 1/4in Bottom Mount 2in Air Gauge 0-100 PSI | link |

| PART # | DESCRIPTION | LINK |
|-----------|--------------------|----------------------|
| 200018008 | Brass Elbow Swivel | link |

200124015



S175416904

| PART # | DESCRIPTION | LINK |
|-----------|----------------------|----------------------|
| 200124015 | Drain Cock Air Valve | link |

| PART # | DESCRIPTION | LINK |
|------------|---------------------------|----------------------|
| S175416904 | Water Tank Flapper O-Ring | link |

| PART # | DESCRIPTION | LINK |
|------------|----------------------------------|----------------------|
| S175416901 | 5 Inch Water Tank Rubber Flapper | link |



S175416901

KIMBLE WATER SYSTEMS

C84T010000



200025006



| PART # | DESCRIPTION | LINK |
|------------|-------------|----------------------|
| C84T010000 | Tee Fitting | link |

| PART # | DESCRIPTION | LINK |
|-----------|---|----------------------|
| 200025006 | .5in NPT x .25in NPT Hex Reducer Nipple | link |

200021102

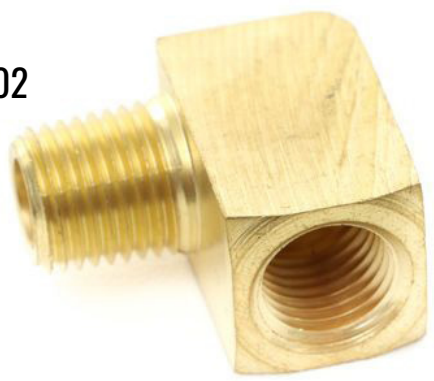

A110020000

| PART # | DESCRIPTION | LINK |
|----------|----------------------|----------------------|
| 20021102 | Street Elbow - Brass | link |

| PART # | DESCRIPTION | LINK |
|------------|--------------------|----------------------|
| A110020000 | Single Check Valve | link |

200018007

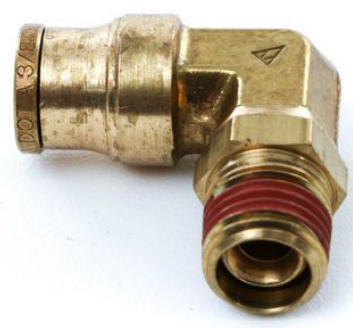

A131010000



| PART # | DESCRIPTION | LINK |
|-----------|---------------|----------------------|
| 200018007 | Brass Push In | link |

| PART # | DESCRIPTION | LINK |
|------------|-----------------|----------------------|
| A131010000 | 3-Way Air Valve | link |

HH00600004



HH00048006



| PART # | DESCRIPTION | LINK |
|------------|--|----------------------|
| HH00600004 | 1in Water Tank Nipple Hose Barb Fitting | link |

| PART # | DESCRIPTION | LINK |
|------------|---------------|----------------------|
| HH00048006 | Elbow Fitting | link |



HH00051006

| PART # | DESCRIPTION | LINK |
|------------|--------------------|----------------------|
| HH00051006 | Schedule 40 Nipple | link |



HH00975005

| PART # | DESCRIPTION | LINK |
|------------|----------------------|----------------------|
| HH00975005 | Add Water Ball Valve | link |

HH00878002



MA19522200



| PART # | DESCRIPTION | LINK |
|------------|----------------------|----------------------|
| HH00878002 | Drain Cock Air Valve | link |

| PART # | DESCRIPTION | LINK |
|------------|-----------------------------|----------------------|
| MA19522200 | 25ft Washdown Water Hose | link |

MD3904302

NO PIC

MB3360600



| PART # | DESCRIPTION | LINK |
|-----------|-------------------------------------|----------------------|
| MD3904302 | 6 Function 12 Foot Pendant Assembly | link |

| PART # | DESCRIPTION | LINK |
|-----------|---------------------------|----------------------|
| MB3360600 | Water Tank Cover Assembly | link |

MA35114



MB3570724

| PART # | DESCRIPTION | LINK |
|---------|--------------------|----------------------|
| MA35114 | Water Tank Coupler | link |

| PART # | DESCRIPTION | LINK |
|-----------|--|----------------------|
| MB3570724 | Sight Gauge Bracket for 24in Dia Water Tanks | link |

HH01096024



HH00978003



| PART # | DESCRIPTION | LINK |
|------------|-------------------------------|----------------------|
| HH01096024 | Water Gauge Connector Fitting | link |

| PART # | DESCRIPTION | LINK |
|------------|--------------|----------------------|
| HH00978003 | Brass Eyelet | link |

HH00980004



HH00979004



| PART # | DESCRIPTION | LINK |
|------------|------------------|----------------------|
| HH00980004 | 3/8in Street Tee | link |

| PART # | DESCRIPTION | LINK |
|------------|---------------------|----------------------|
| HH00979004 | Petcock Drain Valve | link |

HH01092006



HH01095007

| PART # | DESCRIPTION | LINK |
|------------|-------------------------------------|----------------------|
| HH01092006 | 1/2in x 3/8in Brass Reducer Bushing | link |

| PART # | DESCRIPTION | LINK |
|------------|----------------------|----------------------|
| HH01095007 | 3/8in Shut Off Valve | link |

MA3629001



MA3629002

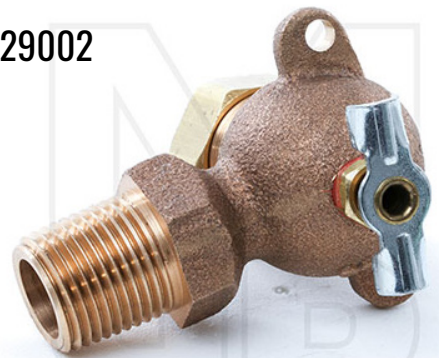

| PART # | DESCRIPTION | LINK |
|-----------|-------------------------|----------------------|
| MA3629001 | Upper Expansion Fixture | link |

| PART # | DESCRIPTION | LINK |
|-----------|------------------------------|----------------------|
| MA3629002 | Water Gauge Fitting - Bottom | link |

MD39709

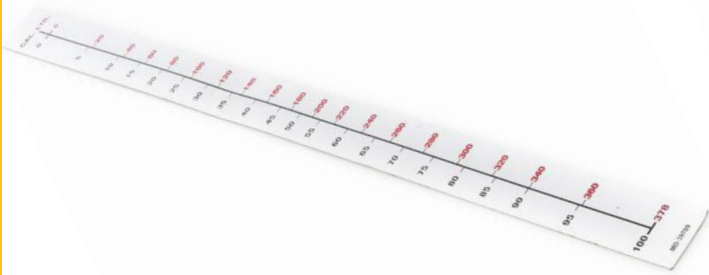

MD39711



| PART # | DESCRIPTION | LINK |
|---------|---|----------------------|
| MD39709 | Water Gauge Strip-100 Gallon/380 Liter 24" Diameter | link |

| PART # | DESCRIPTION | LINK |
|---------|-------------------|----------------------|
| MD39711 | Sight Gauge Strip | link |



430700

| PART # | DESCRIPTION | LINK |
|--------|--|----------------------|
| 430700 | 1/2in Air Safety Relief Valve - 75 PSI, Bronze | link |

MM19850

NO PIC

| PART # | DESCRIPTION | LINK |
|---------|-------------------------|----------------------|
| MM19850 | .25in Brass Check Valve | link |



22778

| PART # | DESCRIPTION | LINK |
|--------|---|----------------------|
| 22778 | 1/4in NPT Air Pressure Protection Valve | link |

MA28572



MM27343



| PART # | DESCRIPTION | LINK |
|---------|-----------------------|----------------------|
| MA28572 | Non-Code Safety Valve | link |

| PART # | DESCRIPTION | LINK |
|---------|--------------------------------|----------------------|
| MM27343 | Three-Way Water Tank Air Valve | link |

MA14870



| PART # | DESCRIPTION | LINK |
|---------|---|----------------------|
| MA14870 | .25in Center Back Mount 2in Air Gauge 0-100 PSI | link |



MA14868

| PART # | DESCRIPTION | LINK |
|---------|-------------------------------------|----------------------|
| MA14868 | Air Regulator - 0-125 psi 1/4in NPT | link |

HH01088002



| PART # | DESCRIPTION | LINK |
|------------|-------------|----------------------|
| HH01088002 | Ball Valve | link |

HH00876001



| PART # | DESCRIPTION | LINK |
|------------|------------------|----------------------|
| HH00876001 | Air Brake Tubing | link |

HH00503001



HH01020001



| PART # | DESCRIPTION | LINK | PART # | DESCRIPTION | LINK |
|------------|------------------|----------------------|------------|----------------------------|----------------------|
| HH00503001 | Air Brake Tubing | link | HH01020001 | Tank Strap Rubber Isolator | link |

0151763



| PART # | DESCRIPTION | LINK |
|---------|----------------------------|----------------------|
| 0151763 | 90 Gallon Steel Water Tank | link |

0151765



| PART # | DESCRIPTION | LINK |
|---------|-----------------------------|----------------------|
| 0151765 | 100 Gallon Steel Water Tank | link |

0151770



| PART # | DESCRIPTION | LINK |
|---------|---|----------------------|
| 0151770 | 125 Gallon Side Mount Water Tank Assembly | link |



0151775

| PART # | DESCRIPTION | LINK |
|---------|---------------------------------------|----------------------|
| 0151775 | 150 Gallon Universal Steel Water Tank | link |

0152927



| PART # | DESCRIPTION | LINK |
|---------|-----------------------------|----------------------|
| 0152927 | 200 Gallon Steel Water Tank | link |

0182750



| PART # | DESCRIPTION | LINK |
|---------|-------------------------------|----------------------|
| 0182750 | 90 Gallon Aluminum Water Tank | link |

MCNEILUS WATER SYSTEMS

0182760



0182770



| PART # | DESCRIPTION | LINK |
|---------|--------------------------------|----------------------|
| 0182760 | 100 Gallon Aluminum Water Tank | link |

| PART # | DESCRIPTION | LINK |
|---------|--|----------------------|
| 0182770 | 125 Gallon Aluminum Universal Water Tank | link |

0182800



| PART # | DESCRIPTION | LINK |
|---------|--|----------------------|
| 0182800 | 150 Gallon Aluminum Universal Water Tank | link |

0182720



0153835

no pic

| PART # | DESCRIPTION | LINK |
|---------|-----------------------------|----------------------|
| 0153835 | Aluminum Water - Admix Tank | link |

| PART # | DESCRIPTION | LINK |
|---------|---|----------------------|
| 0182720 | 3 Position Momentary Cab Station Switch | link |

0152835

no pic

0150830



| PART # | DESCRIPTION | LINK |
|---------|---------------------------------|----------------------|
| 0152835 | Steel 125/15 Add Mix Water Tank | link |

| PART # | DESCRIPTION | LINK |
|---------|------------------------------------|----------------------|
| 0150830 | 6.75in Water Tank Flapper Assembly | link |

0150832



0150833

| PART # | DESCRIPTION | LINK |
|---------|---|----------------------|
| 0150832 | Flapper Flange - Water Tank Flopper Cover | link |

| PART # | DESCRIPTION | LINK |
|---------|--|----------------------|
| 0150833 | Steel Water Tank Flapper Filler Base for Steel Water Tanks | link |

0182768



0182840

no pic

| PART # | DESCRIPTION | LINK |
|---------|---|----------------------|
| 0182768 | Aluminum Water Tank Flapper Filler Base | link |

| PART # | DESCRIPTION | LINK |
|---------|----------------------------|----------------------|
| 0182840 | Water Tank Handle Weldment | link |

0120182



| PART # | DESCRIPTION | LINK |
|---------|------------------------------|----------------------|
| 0120182 | Grade C Steel 3/4-10 Locknut | link |

0182874



| PART # | DESCRIPTION | LINK |
|---------|------------------------|----------------------|
| 0182874 | Cross Mount Tank Strap | link |

1169028



| PART # | DESCRIPTION | LINK |
|---------|--|----------------------|
| 1169028 | Water Tank Strap for 26" Diameter Water Tank - Top, Side Mount | link |



0082526

| PART # | DESCRIPTION | LINK |
|---------|---|----------------------|
| 0082526 | Water Tank Strap Rubber 2.625in x 10ft Long | link |

0215217



| PART # | DESCRIPTION | LINK |
|---------|--|----------------------|
| 0215217 | Water Tank Rubber Strip-2" Wide x 1/8" Thick | link |

0500485

no pic

| PART # | DESCRIPTION | LINK |
|---------|--------------------------------|----------------------|
| 0500485 | Cross Mount Water Tank Bracket | link |

1225135

no pic

1164929



| PART # | DESCRIPTION | LINK |
|---------|--|----------------------|
| 1225135 | Cross Mount Low Mount Bracket for 30in 200 Gallon Tank | link |

| PART # | DESCRIPTION | LINK |
|---------|---|----------------------|
| 1164929 | 3/4-10 X 2.75in Grade 8 Hex Head Cap Screw YZ | link |

0152761



no pic

| PART # | DESCRIPTION | LINK |
|---------|---------------------|----------------------|
| 0152761 | Sight Gauge Bracket | link |

| PART # | DESCRIPTION | LINK |
|---------|------------------------------|----------------------|
| 0150766 | Water Tank Sight Gauge Mount | link |

0102021

no pic

| PART # | DESCRIPTION | LINK |
|---------|----------------------|----------------------|
| 0102021 | Black Push Lock Hose | link |

0201600



| PART # | DESCRIPTION | LINK |
|---------|---------------------------------|----------------------|
| 0201600 | Drain Cock Eternal Seat Petcock | link |

0152774

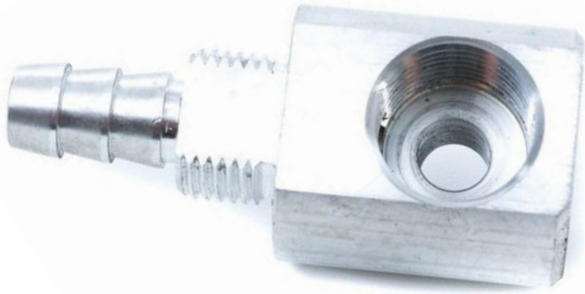

0101563



| PART # | DESCRIPTION | LINK |
|---------|------------------|----------------------|
| 0152774 | Water Gauge Body | link |

| PART # | DESCRIPTION | LINK |
|---------|---|----------------------|
| 0101563 | Water Gauge Compression Fitting Adapter | link |

0082386

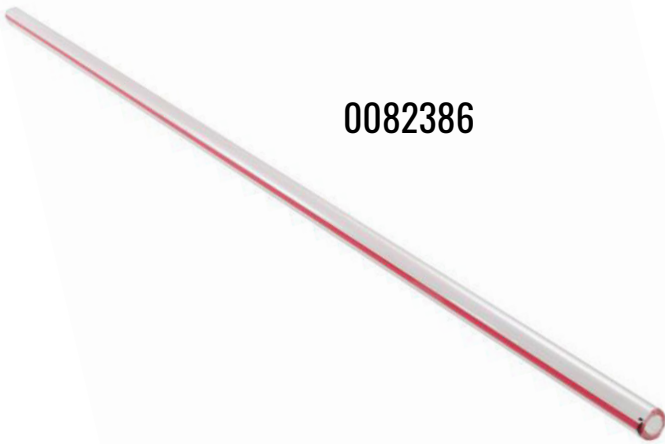

1168364

| PART # | DESCRIPTION | LINK |
|---------|--|----------------------|
| 0082386 | 36in Acrylic Water Tank Sight Tube with Red Line | link |

| PART # | DESCRIPTION | LINK |
|---------|-------------------------------------|----------------------|
| 1168364 | 72in Sight Gauge Tube with Red Line | link |

0115908



0103384

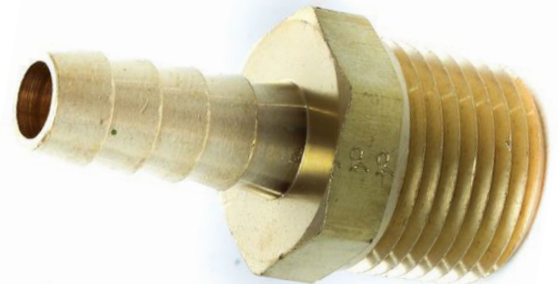

| PART # | DESCRIPTION | LINK |
|---------|--------------------------------|----------------------|
| 0115908 | Blue Floating Sight Gauge Ball | link |

| PART # | DESCRIPTION | LINK |
|---------|------------------|----------------------|
| 0103384 | Push Lock Nipple | link |



0101291

0101564

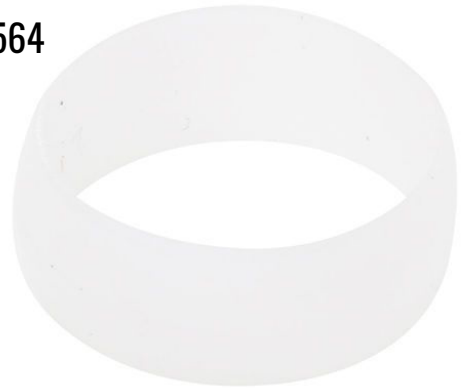

| PART # | DESCRIPTION | LINK |
|---------|-------------------|----------------------|
| 0101291 | Water Gauge Valve | link |

| PART # | DESCRIPTION | LINK |
|---------|-----------------------------------|----------------------|
| 0101564 | Water Gauge Adapter Delrin Sleeve | link |

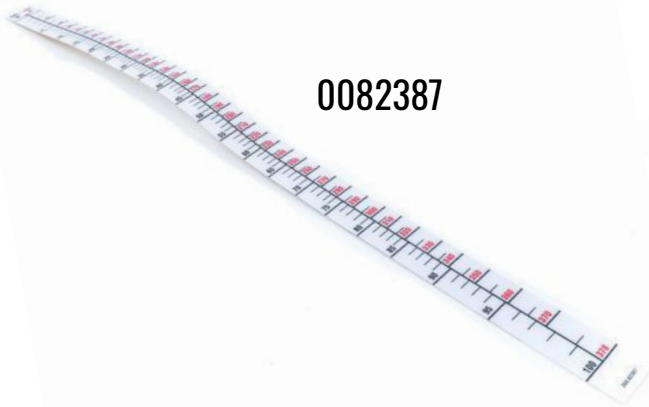

0082387



1262236

| PART # | DESCRIPTION | LINK |
|---------|--|----------------------|
| 0082387 | Water Gauge Strip - 100 Gallon X 26 Diameter | link |

| PART # | DESCRIPTION | LINK |
|---------|-----------------------------------|----------------------|
| 1262236 | 150 Gallon Water Tank Sight Strip | link |

0115103

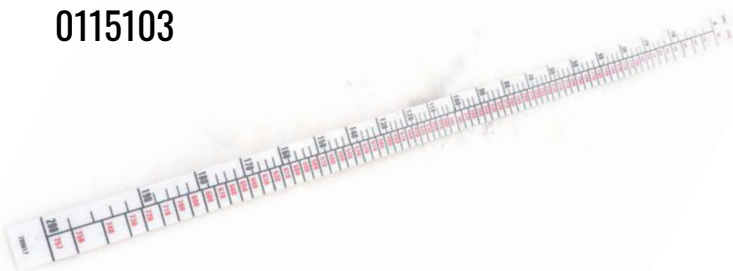

0082406

| PART # | DESCRIPTION | LINK |
|---------|-------------------------------------|----------------------|
| 0115103 | 200 Gallon Gauge Strip - 30in Tanks | link |

| PART # | DESCRIPTION | LINK |
|---------|---|----------------------|
| 0082406 | .25in Center Back Mount 2in Air Gauge 0-100 PSI | link |

MCNEILUS WATER SYSTEMS



0150824

1169462



| PART # | DESCRIPTION | LINK |
|---------|---|----------------------|
| 0150824 | Air Pressure 3-Way Valve Block Assembly | link |

| PART # | DESCRIPTION | LINK |
|---------|------------------------------|----------------------|
| 1169462 | Air Pressure Valve Cartridge | link |

0101251

no pic

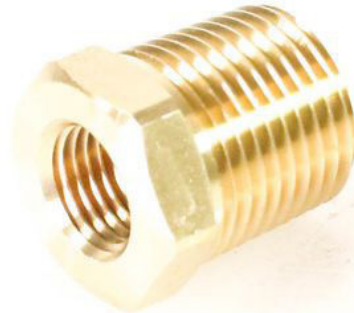

0101252

| PART # | DESCRIPTION | LINK |
|---------|---|----------------------|
| 0101251 | Water Line Hose Barb Drain Tee - 1.0x1.0x0.50 | link |

| PART # | DESCRIPTION | LINK |
|---------|--|----------------------|
| 0101252 | 0.50in MNPT x .25in FNPT Brass Reducer Bushing | link |

0082416



0082117



| PART # | DESCRIPTION | LINK |
|---------|-----------------|----------------------|
| 0082416 | 1/4" Drain Cock | link |

| PART # | DESCRIPTION | LINK |
|---------|---|----------------------|
| 0082117 | 1in Water Tank Nipple Hose Barb Fitting | link |

0101585



0101129



| PART # | DESCRIPTION | LINK |
|---------|--|----------------------|
| 0101585 | Brass DOT Connector Compression 1/2 Tube x 1/2 MPT | link |

| PART # | DESCRIPTION | LINK |
|---------|-------------|----------------------|
| 0101129 | Tee Fitting | link |

0082407



1141719

| PART # | DESCRIPTION | LINK |
|---------|--|----------------------|
| 0082407 | 1/2in Bronze Air Safety Relief Valve - 60PSI | link |

| PART # | DESCRIPTION | LINK |
|---------|----------------|----------------------|
| 1141719 | 1in Ball Valve | link |

0082109



1178675

| PART # | DESCRIPTION | LINK |
|---------|---|----------------------|
| 0082109 | Steel Water Line Tee Assembly 1in x 1in x 3/4in | link |

| PART # | DESCRIPTION | LINK |
|---------|-----------------------------|----------------------|
| 1178675 | Malleable Iron Straight Tee | link |

0082098



| PART # | DESCRIPTION | LINK |
|---------|------------------|----------------------|
| 0082098 | 3/4in Ball Valve | link |

0082247



| PART # | DESCRIPTION | LINK |
|---------|--|----------------------|
| 0082247 | 3/4 Male Truck Washdown Hose x 3/4 Male Pipe Adapter | link |

0102028



| PART # | DESCRIPTION | LINK |
|---------|--------------------|----------------------|
| 0102028 | Hose Formed Heater | link |



0082242

| PART # | DESCRIPTION | LINK |
|---------|--------------------------|----------------------|
| 0082242 | 25ft Washdown Water Hose | link |

0082243



| PART # | DESCRIPTION | LINK |
|---------|----------------------------|----------------------|
| 0082243 | Pistol Grip Washout Nozzle | link |

0102025



| PART # | DESCRIPTION | LINK |
|---------|---------------------|----------------------|
| 0102025 | Washdown Water Hose | link |

0082240



0000007



| PART # | DESCRIPTION | LINK |
|---------|---------------------------|----------------------|
| 0082240 | Brass Quick Connector Set | link |

| PART # | DESCRIPTION | LINK |
|---------|----------------------------------|----------------------|
| 0000007 | 1/2in Black DOT Air Brake Tubing | link |



0108504

| PART # | DESCRIPTION | LINK |
|---------|------------------------------------|----------------------|
| 0108504 | Ball Valve - 1in NPT Spring Return | link |



0082097

| PART # | DESCRIPTION | LINK |
|---------|-------------|----------------------|
| 0082097 | Ball Valve | link |

0101306



| PART # | DESCRIPTION | LINK |
|---------|-------------|----------------------|
| 0101306 | Ball Valve | link |



1243933

| PART # | DESCRIPTION | LINK |
|---------|--|----------------------|
| 1243933 | Brass DOT Connector Compression 1/2Tube x 1/2MPT | link |

0121500



0101206



| PART # | DESCRIPTION | LINK |
|---------|---------------|----------------------|
| 0121500 | Elbow Fitting | link |

| PART # | DESCRIPTION | LINK |
|---------|--------------------|----------------------|
| 0101206 | Schedule 40 Nipple | link |

1263722



0114009

| PART # | DESCRIPTION | LINK |
|---------|-------------|----------------------|
| 1263722 | Ball Valve | link |

| PART # | DESCRIPTION | LINK |
|---------|--------------------------------|----------------------|
| 0114009 | Water Meter - 1in Electric GPI | link |

30386490

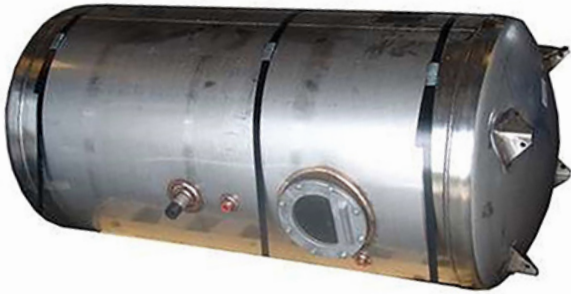

| PART # | DESCRIPTION | LINK |
|----------|-------------------------------|----------------------|
| 30386490 | 90 Gallon Aluminum Water Tank | link |

30389223

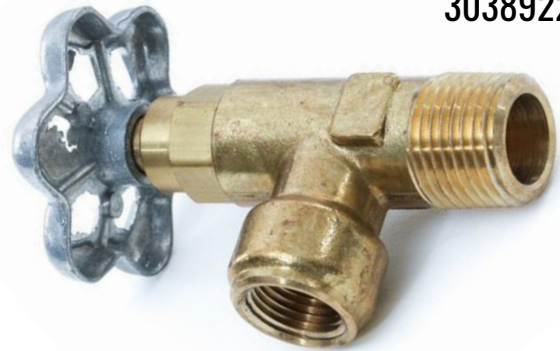

| PART # | DESCRIPTION | LINK |
|----------|---|----------------------|
| 30389223 | 1/2in Male x 3/8in Female Water Gauge Valve | link |

30330859



| PART # | DESCRIPTION | LINK |
|----------|---------------|----------------------|
| 30330859 | Elbow Fitting | link |



30389225

| PART # | DESCRIPTION | LINK |
|----------|---|----------------------|
| 30389225 | 1in Water Tank Nipple Hose Barb Fitting | link |

30389034



| PART # | DESCRIPTION | LINK |
|----------|--|----------------------|
| 30389034 | 125 Gallon Aluminum Universal Water Tank | link |

30389053

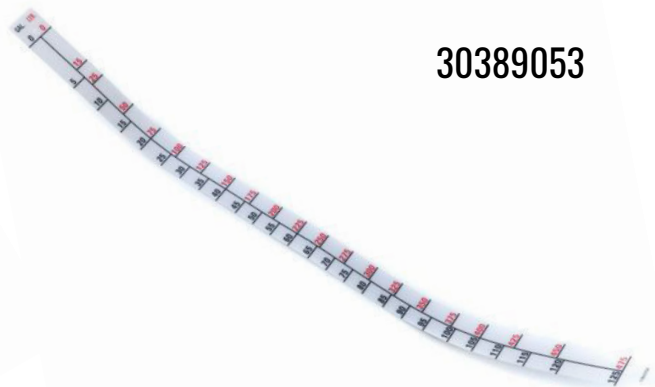

| PART # | DESCRIPTION | LINK |
|----------|--------------------------|----------------------|
| 30389053 | 125Gal Water Level Decal | link |

30389316

no pic

30389438

no pic

| PART # | DESCRIPTION | LINK |
|----------|---|----------------------|
| 30389316 | Water/Admix Tank 135/15 Gallon Aluminum | link |

| PART # | DESCRIPTION | LINK |
|----------|---|----------------------|
| 30389438 | Water Tank 150 Gallon - Stainless Steel | link |

30389441

30389249

| PART # | DESCRIPTION | LINK |
|----------|-----------------------------------|----------------------|
| 30389441 | 150 Gallon Water Tank Sight Strip | link |

| PART # | DESCRIPTION | LINK |
|----------|-------------------|----------------------|
| 30389249 | Water Gauge Strip | link |



30389033

30389241

| PART # | DESCRIPTION | LINK |
|----------|------------------|----------------------|
| 30389033 | Steel Water Tank | link |

| PART # | DESCRIPTION | LINK |
|----------|---|----------------------|
| 30389241 | 125 Gallon Side Mount Water Tank Assembly | link |

30389437



30325547



| PART # | DESCRIPTION | LINK |
|----------|---------------------------------------|----------------------|
| 30389437 | 150 Gallon Universal Steel Water Tank | link |

| PART # | DESCRIPTION | LINK |
|----------|---------------------------------------|----------------------|
| 30325547 | Water Tank 200 Gallon Steel Universal | link |

30386448

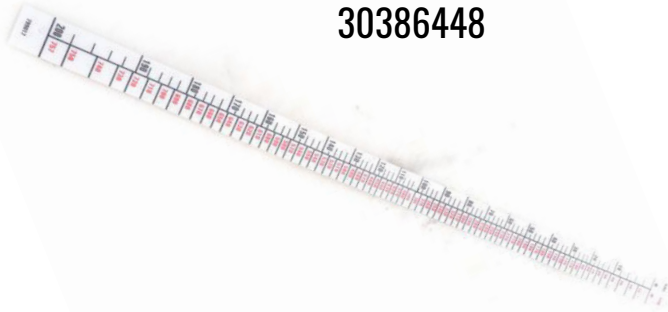

30389233

| PART # | DESCRIPTION | LINK |
|----------|-------------------------|----------------------|
| 30386448 | 200 Gallon Strip - 30in | link |

| PART # | DESCRIPTION | LINK |
|----------|---------------------------|----------------------|
| 30389233 | Water Tank Flapper Flange | link |

30389234



30389248

| PART # | DESCRIPTION | LINK |
|----------|-------------------------------|----------------------|
| 30389234 | Water Tank Flapper Valve Disc | link |

| PART # | DESCRIPTION | LINK |
|----------|--|----------------------|
| 30389248 | 6.75in Water Tank Flapper Assembly - Flopper Kit | link |

SCHWING WATER SYSTEMS

30389235



30389236



| PART # | DESCRIPTION | LINK |
|----------|--|----------------------|
| 30389235 | Water Tank Flapper Spring for 30389248 Flopper | link |

| PART # | DESCRIPTION | LINK |
|----------|---------------------------|----------------------|
| 30389236 | Water Tank Flopper Gasket | link |

30308873



30389221

| PART # | DESCRIPTION | LINK |
|----------|-------------------------------------|----------------------|
| 30308873 | 72in Sight Gauge Tube with Red Line | link |

| PART # | DESCRIPTION | LINK |
|----------|---|----------------------|
| 30389221 | Water Gauge Compression Fitting Adapter | link |

30389219



30359360



| PART # | DESCRIPTION | LINK |
|----------|-----------------------------|----------------------|
| 30389219 | 3/8in Brass Male Branch Tee | link |

| PART # | DESCRIPTION | LINK |
|----------|-----------------|----------------------|
| 30359360 | 90 Degree Elbow | link |

30389220



30389218



| PART # | DESCRIPTION | LINK |
|----------|-----------------------------------|----------------------|
| 30389220 | 3/8in External Seat Drain Petcock | link |

| PART # | DESCRIPTION | LINK |
|----------|-----------------|----------------------|
| 30389218 | Anchor Coupling | link |

30389052



| PART # | DESCRIPTION | LINK |
|----------|---|----------------------|
| 30389052 | 26in Diameter Side Mount Tank Gauge Bracket | link |



30389217

| PART # | DESCRIPTION | LINK |
|----------|----------------------------------|----------------------|
| 30389217 | 3/8in X 3/8in Brass Barb Fitting | link |

30389195



| PART # | DESCRIPTION | LINK |
|----------|-----------------------|----------------------|
| 30389195 | Locknut 3/8-16 Nylock | link |

30386535



| PART # | DESCRIPTION | LINK |
|----------|---|----------------------|
| 30386535 | 26in Side Mount Water Tank Weldment Bracket | link |

30389999



| PART # | DESCRIPTION | LINK |
|--------|-------------|------|
|--------|-------------|------|

| | | |
|----------|---|----------------------|
| 30389999 | 2.25in Wide x 48.5in Long Rubber Insulator Tank Strap | link |
|----------|---|----------------------|

30386355



| PART # | DESCRIPTION | LINK |
|--------|-------------|------|
|--------|-------------|------|

| | | |
|----------|--------------------------------|----------------------|
| 30386355 | 26in Diameter Water Tank Strap | link |
|----------|--------------------------------|----------------------|



30303371

| PART # | DESCRIPTION | LINK |
|--------|-------------|------|
|--------|-------------|------|

| | | |
|----------|----------------|----------------------|
| 30303371 | Nipple Fitting | link |
|----------|----------------|----------------------|



30389838

| PART # | DESCRIPTION | LINK |
|--------|-------------|------|
|--------|-------------|------|

| | | |
|----------|-----------------------------------|----------------------|
| 30389838 | Spring Return Ball Valve - 1inNPT | link |
|----------|-----------------------------------|----------------------|

30309420



| PART # | DESCRIPTION | LINK |
|--------|-------------|------|
|--------|-------------|------|

| | | |
|----------|--------------|----------------------|
| 30309420 | Hose Adapter | link |
|----------|--------------|----------------------|

30386644



| PART # | DESCRIPTION | LINK |
|--------|-------------|------|
|--------|-------------|------|

| | | |
|----------|--|----------------------|
| 30386644 | Brass 3/8in x 3/8in x 1/4in Male Branch Swivel Tee | link |
|----------|--|----------------------|

30305009



30309505



| PART # | DESCRIPTION | LINK |
|----------|------------------------|----------------------|
| 30305009 | 3/8in Black DOT Tubing | link |

| PART # | DESCRIPTION | LINK |
|----------|-------------|----------------------|
| 30309505 | Ball Valve | link |

30351528

no pic



30389273

| PART # | DESCRIPTION | LINK |
|----------|--|----------------------|
| 30351528 | Fitting Push Lock 90 Degree Elbow 1/4in NPT X 3/8in Tube | link |

| PART # | DESCRIPTION | LINK |
|----------|--------------|----------------------|
| 30389273 | Safety Valve | link |

30357012



| PART # | DESCRIPTION | LINK |
|----------|-------------|----------------------|
| 30357012 | Tee Fitting | link |

BECK SWITCHES & ACCESSORIES

31514



31515

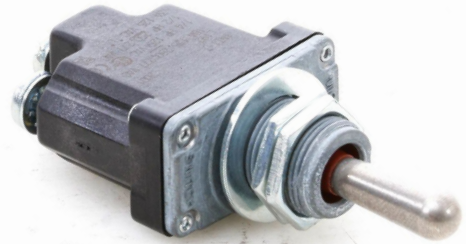

| PART # | DESCRIPTION | LINK |
|--------|-------------|------|
|--------|-------------|------|

31514 On Off Sealed Toggle Switch [link](#)

| PART # | DESCRIPTION | LINK |
|--------|-------------|------|
|--------|-------------|------|

31515 2-Position Momentary Switch [link](#)



33010



33012

| PART # | DESCRIPTION | LINK |
|--------|-------------|------|
|--------|-------------|------|

33010 Magnetic Pencil Proximity Drum Counter Sensor [link](#)

| PART # | DESCRIPTION | LINK |
|--------|-------------|------|
|--------|-------------|------|

33012 Magnetic Drum Counter Bolt [link](#)

33015

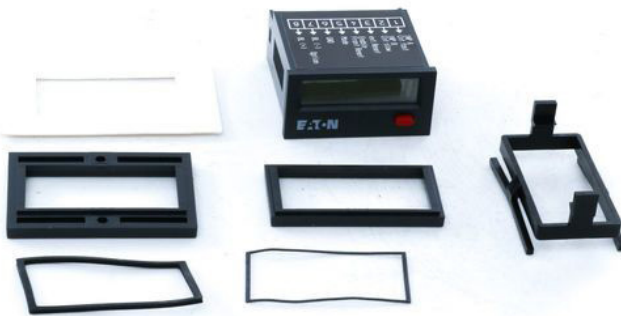

35100



| PART # | DESCRIPTION | LINK |
|--------|-------------|------|
|--------|-------------|------|

33015 Digital Drum Counter with LCD Display [link](#)

| PART # | DESCRIPTION | LINK |
|--------|-------------|------|
|--------|-------------|------|

35100 Half Toggle Switch Boot with Black Guard [link](#)

36000S



36100



| PART # | DESCRIPTION | LINK |
|--------|--|----------------------|
| 36000S | Black Dipped Toggle Switch with Pigtails | link |

| PART # | DESCRIPTION | LINK |
|--------|---|----------------------|
| 36100 | 3 Position Momentary Cab Station Switch | link |

36120



| PART # | DESCRIPTION | LINK |
|--------|--------------------------------|----------------------|
| 36120 | Rocker Switch - On Off Red Red | link |

36311



| PART # | DESCRIPTION | LINK |
|--------|--------------------------------|----------------------|
| 36311 | Rocker Switch - On Off Red Red | link |

36321



| PART # | DESCRIPTION | LINK |
|--------|-----------------------|----------------------|
| 36321 | Rocker with Engraving | link |

36322



| PART # | DESCRIPTION | LINK |
|--------|-----------------|----------------------|
| 36322 | Engraved Switch | link |

BECK SWITCHES & ACCESSORIES

36323



36332



| PART # | DESCRIPTION | LINK |
|--------|--------------------------------|----------------------|
| 36323 | Charge/Discharge Paddle Switch | link |

| PART # | DESCRIPTION | LINK |
|--------|--|----------------------|
| 36332 | Chute Centering Short Proximity Switch | link |

36366



36368

| PART # | DESCRIPTION | LINK |
|--------|-------------------------|----------------------|
| 36366 | 2 Wire Proximity Switch | link |

| PART # | DESCRIPTION | LINK |
|--------|---------------------------------------|----------------------|
| 36368 | 32in 4 Wire Proximity Switch Assembly | link |

36341



36344

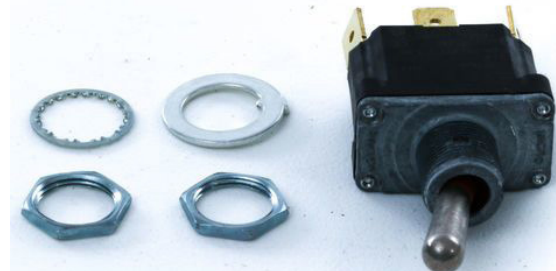

| PART # | DESCRIPTION | LINK |
|--------|-----------------|----------------------|
| 36341 | Pressure Switch | link |

| PART # | DESCRIPTION | LINK |
|--------|-----------------------|----------------------|
| 36344 | On/ Off Toggle Switch | link |

36354



36359



| PART # | DESCRIPTION | LINK |
|--------|------------------------------------|----------------------|
| 36354 | 3 Position Momentary Toggle Switch | link |

| PART # | DESCRIPTION | LINK |
|--------|-----------------|----------------------|
| 36359 | Pressure Switch | link |

36324



| PART # | DESCRIPTION | LINK |
|--------|---------------------------|----------------------|
| 36324 | Hopper Up Electric Switch | link |

36325



| PART # | DESCRIPTION | LINK |
|--------|----------------------------|----------------------|
| 36325 | Chute Lock Electric Switch | link |

31815



| PART # | DESCRIPTION | LINK |
|--------|------------------|----------------------|
| 31815 | MCL Main Harness | link |

92003LED



| PART # | DESCRIPTION | LINK |
|----------|---------------|----------------------|
| 92003LED | Red LED Light | link |

BECK SWITCHES & ACCESSORIES

92004LED



92516

no pic

| PART # | DESCRIPTION | LINK |
|----------|-----------------|----------------------|
| 92004LED | Amber LED Light | link |

| PART # | DESCRIPTION | LINK |
|--------|--------------------|----------------------|
| 92516 | Halogen Work Light | link |

92516LED

no pic



92540LED

| PART # | DESCRIPTION | LINK |
|----------|-------------|----------------------|
| 92516LED | Work Light | link |

| PART # | DESCRIPTION | LINK |
|----------|-----------------------------|----------------------|
| 92540LED | Red Grommet Mount LED Light | link |

92541LED



92542



| PART # | DESCRIPTION | LINK |
|----------|---------------|----------------------|
| 92541LED | LED Light Kit | link |

| PART # | DESCRIPTION | LINK |
|--------|---------------|----------------------|
| 92542 | Light Grommet | link |

92545



92546



| PART # | DESCRIPTION | LINK | PART # | DESCRIPTION | LINK |
|--------|---------------------------|----------------------|--------|--|----------------------|
| 92545 | 2.5in Closed Back Grommet | link | 92546 | LP91 License Light w/ Bracket & Gasket | link |

CONTINENTAL ELECTRICAL CONTROLS

10801808



10801810



| PART # | DESCRIPTION | LINK |
|--------|-------------|------|
|--------|-------------|------|

10801808 Control On/Off/On Momentary Yellow Dipped Toggle Switch with Pigtails [link](#)

| PART # | DESCRIPTION | LINK |
|--------|-------------|------|
|--------|-------------|------|

10801810 Blue Electric Switch [link](#)

10801815

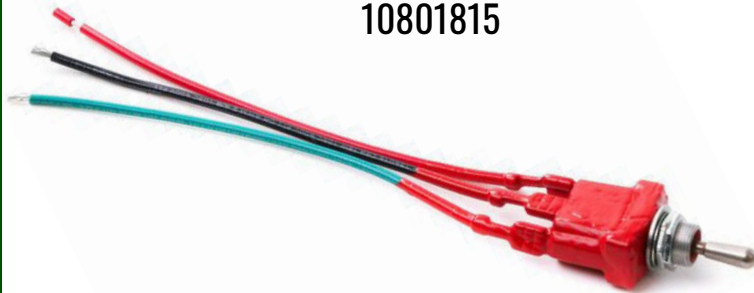

10802203

| PART # | DESCRIPTION | LINK |
|--------|-------------|------|
|--------|-------------|------|

10801815 Control On/Off/On Red Dipped Toggle Switch with Pigtails [link](#)

| PART # | DESCRIPTION | LINK |
|--------|-------------|------|
|--------|-------------|------|

10802203 Electric Rocker Switch for Cab Control [link](#)

10802205

no pic



10802206

| PART # | DESCRIPTION | LINK |
|--------|-------------|------|
|--------|-------------|------|

10802205 Rocker Switch - On Off Green [link](#)

| PART # | DESCRIPTION | LINK |
|--------|-------------|------|
|--------|-------------|------|

10802206 Rocker Switch - Interlock Bridgemaster [link](#)

10802213



10802214



| PART # | DESCRIPTION | LINK |
|----------|-----------------------------|----------------------|
| 10802213 | Chute Control Paddle Switch | link |

| PART # | DESCRIPTION | LINK |
|----------|------------------------|----------------------|
| 10802214 | Electric Rocker Switch | link |

10802215



| PART # | DESCRIPTION | LINK |
|----------|---|----------------------|
| 10802215 | Rocker Switch for Cooler Fan - On Off Red | link |



10801634

| PART # | DESCRIPTION | LINK |
|----------|--------------------------|----------------------|
| 10801634 | Chute Lift Rocker Switch | link |

80802206



| PART # | DESCRIPTION | LINK |
|----------|--|----------------------|
| 80802206 | Rocker Switch - Bridgemaster In Motion | link |

10432608



| PART # | DESCRIPTION | LINK |
|----------|----------------------|----------------------|
| 10432608 | Digital Drum Counter | link |

CONTINENTAL ELECTRICAL CONTROLS

10800808

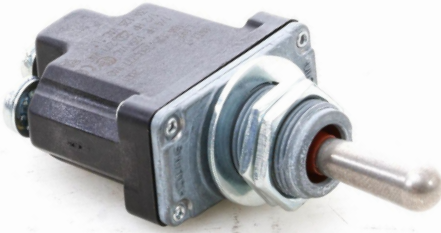

10800810



| PART # | DESCRIPTION | LINK |
|----------|-----------------------------|----------------------|
| 10800808 | 2-Position Momentary Switch | link |

| PART # | DESCRIPTION | LINK |
|----------|-----------------------------|----------------------|
| 10800810 | On Off Sealed Toggle Switch | link |

10432900



10430904

| PART # | DESCRIPTION | LINK |
|----------|---|----------------------|
| 10432900 | Magnetic Pencil Proximity Drum Counter Sensor | link |

| PART # | DESCRIPTION | LINK |
|----------|--|----------------------|
| 10430904 | 4 Wire Proximity Switch with 6ft Leads | link |

10431903



10202502

| PART # | DESCRIPTION | LINK |
|----------|---------------------------|----------------------|
| 10431903 | Proximity Switch - 3 Wire | link |

| PART # | DESCRIPTION | LINK |
|----------|---------------------------------|----------------------|
| 10202502 | Hydraulic Chute Pressure Switch | link |

715022



715026

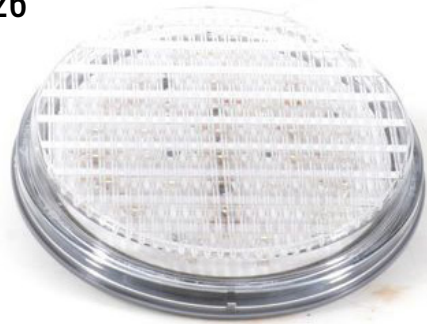

| PART # | DESCRIPTION | LINK |
|--------|-----------------------------|----------------------|
| 715022 | Red Grommet Mount LED Light | link |

| PART # | DESCRIPTION | LINK |
|--------|---------------|----------------------|
| 715026 | LED Light Kit | link |

715024



715023

| PART # | DESCRIPTION | LINK |
|--------|-----------------|----------------------|
| 715024 | Amber LED Light | link |

| PART # | DESCRIPTION | LINK |
|--------|------------------------|----------------------|
| 715023 | 2.5-Inch Red LED Light | link |

715850



715851

no pic

| PART # | DESCRIPTION | LINK |
|--------|--------------------|----------------------|
| 715850 | Amber Marker Light | link |

| PART # | DESCRIPTION | LINK |
|--------|---------------|----------------------|
| 715851 | Red LED Light | link |

715019



715001



| PART # | DESCRIPTION | LINK |
|--------|-------------|------|
|--------|-------------|------|

| | | |
|--------|---|----------------------|
| 715019 | LP91 License Light w/ Bracket & Gasket | link |
|--------|---|----------------------|

| PART # | DESCRIPTION | LINK |
|--------|-------------|------|
|--------|-------------|------|

| | | |
|--------|------------------------------|----------------------|
| 715001 | 2.5in Closed Back Grommet | link |
|--------|------------------------------|----------------------|



715002



715004

| PART # | DESCRIPTION | LINK |
|--------|-------------|------|
|--------|-------------|------|

| | | |
|--------|---|----------------------|
| 715002 | 2.5in Open Back Recess Mount Light Grommet | link |
|--------|---|----------------------|

| PART # | DESCRIPTION | LINK |
|--------|-------------|------|
|--------|-------------|------|

| | | |
|--------|----------------------------------|----------------------|
| 715004 | 4in Rubber Light Lamp Grommet | link |
|--------|----------------------------------|----------------------|

2652



24694

no pic

| PART # | DESCRIPTION | LINK |
|--------|-------------------------------|----------------------|
| 2652 | 4in Rubber Light Lamp Grommet | link |

| PART # | DESCRIPTION | LINK |
|--------|---------------|----------------------|
| 24694 | Red LED Light | link |

24695



| PART # | DESCRIPTION | LINK |
|--------|-----------------|----------------------|
| 24695 | Amber LED Light | link |

24696



| PART # | DESCRIPTION | LINK |
|--------|-----------------------------|----------------------|
| 24696 | Red Grommet Mount LED Light | link |

24698



| PART # | DESCRIPTION | LINK |
|--------|----------------------------|----------------------|
| 24698 | Round Light Rubber Grommet | link |

24702



| PART # | DESCRIPTION | LINK |
|--------|---------------|----------------------|
| 24702 | LED Light Kit | link |

2658



2638



| PART # | DESCRIPTION | LINK | PART # | DESCRIPTION | LINK |
|--------|--|----------------------|--------|---------------|----------------------|
| 2658 | 2.5in Open Back Recess Mount Light Grommet | link | 2638 | Rocker Switch | link |

C2344327



7681

| PART # | DESCRIPTION | LINK | PART # | DESCRIPTION | LINK |
|----------|-----------------------|----------------------|--------|------------------|----------------------|
| C2344327 | Side Mount Work Light | link | 7681 | Proximity Switch | link |

| PART # | DESCRIPTION | LINK |
|--------|-----------------------|----------------------|
| H10183 | Wiring Harness for B2 | link |

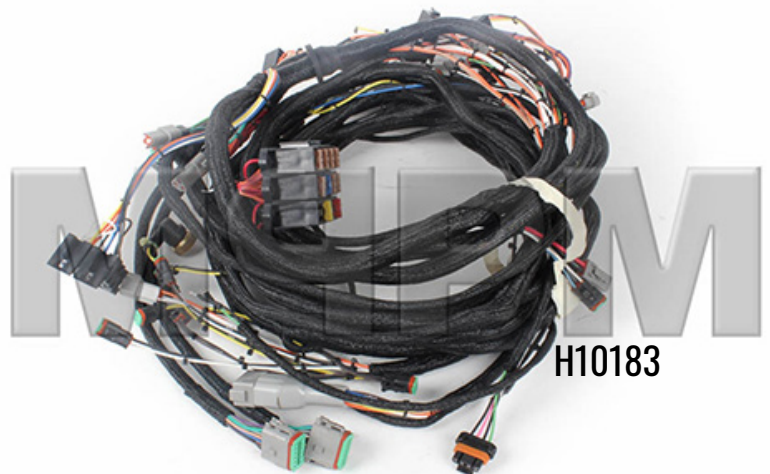

H10183

300221008



300221003



| PART # | DESCRIPTION | LINK |
|-----------|--------------|----------------------|
| 300221008 | Buzzer Alarm | link |

| PART # | DESCRIPTION | LINK |
|-----------|-------------|----------------------|
| 300221003 | Joystick | link |

300221001

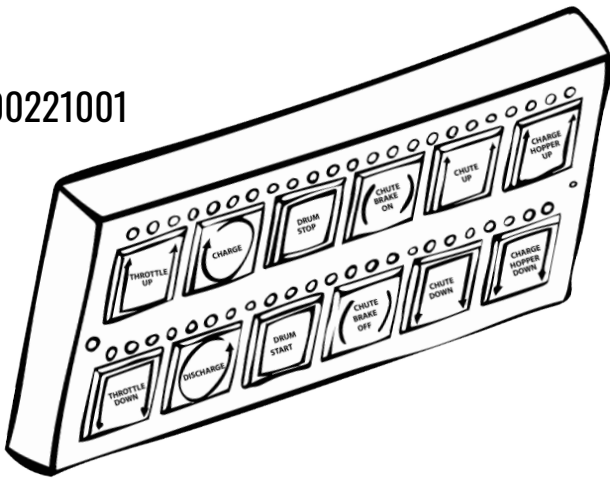

| PART # | DESCRIPTION | LINK |
|-----------|---------------------|----------------------|
| 300221001 | Rear Pendant Keypad | link |



E519777800

| PART # | DESCRIPTION | LINK |
|------------|--------------------|----------------------|
| E519777800 | Halogen Work Light | link |

E519777801



| PART # | DESCRIPTION | LINK |
|------------|-------------|----------------------|
| E519777801 | Work Light | link |

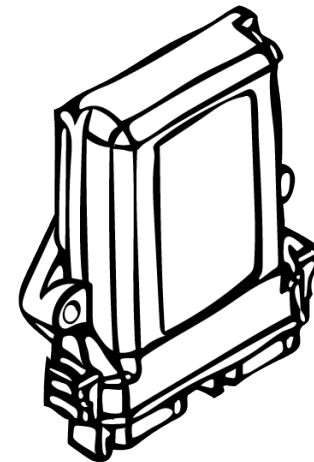

300221004

| PART # | DESCRIPTION | LINK |
|-----------|-------------------------|----------------------|
| 300221004 | Control Module Receiver | link |

300028903



| PART # | DESCRIPTION | LINK |
|-----------|---------------|----------------------|
| 300028903 | LED Light Kit | link |



300028904

| PART # | DESCRIPTION | LINK |
|-----------|-------------------------------|----------------------|
| 300028904 | 4in Rubber Light Lamp Grommet | link |



300028905

| PART # | DESCRIPTION | LINK |
|-----------|-----------------------------|----------------------|
| 300028905 | Red Grommet Mount LED Light | link |



E523025000

| PART # | DESCRIPTION | LINK |
|------------|--------------------------------|----------------------|
| E523025000 | Red Round Marker Grommet Mount | link |

C910307100



| PART # | DESCRIPTION | LINK |
|------------|------------------------------------|----------------------|
| C910307100 | Flush Mount Grommet for 2in Lights | link |

300225055



| PART # | DESCRIPTION | LINK |
|-----------|--|----------------------|
| 300225055 | Harness for Trailer Alarm from 300042-701 Module | link |

H321020000

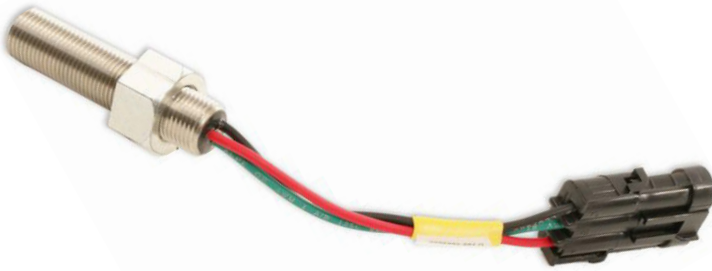

E141000100



| PART # | DESCRIPTION | LINK |
|------------|----------------------------|----------------------|
| H321020000 | Drum Constant Speed Sensor | link |

| PART # | DESCRIPTION | LINK |
|------------|-------------------------|----------------------|
| E141000100 | 5 Wire Proximity Switch | link |

E151000205



| PART # | DESCRIPTION | LINK |
|------------|-----------------|----------------------|
| E151000205 | Magnetic Switch | link |



E170015000

| PART # | DESCRIPTION | LINK |
|------------|--------------------|----------------------|
| E170015000 | Temperature Sensor | link |

E351000600



| PART # | DESCRIPTION | LINK |
|------------|-----------------------|----------------------|
| E351000600 | Electric Latch Module | link |

200041092



| PART # | DESCRIPTION | LINK |
|-----------|---|----------------------|
| 200041092 | 3 Wire Dual Pressure Switch with Connectors | link |



E100000500



E911000200



| PART # | DESCRIPTION | LINK | PART # | DESCRIPTION | LINK |
|------------|---------------------------|----------------------|------------|--|----------------------|
| E100000500 | Toggle Switch - On-Off-On | link | E911000200 | Half Toggle Switch Boot with Black Guard | link |

MA26602

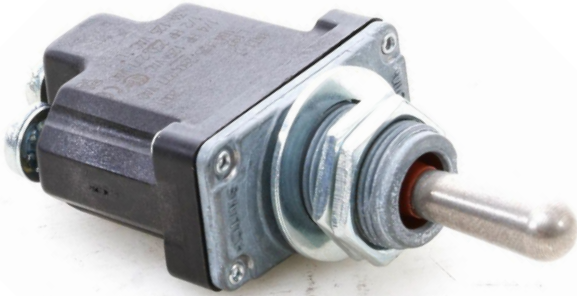

MA40216

| PART # | DESCRIPTION | LINK |
|---------|-----------------------------|----------------------|
| MA26602 | 2-Position Momentary Switch | link |

| PART # | DESCRIPTION | LINK |
|---------|---|----------------------|
| MA40216 | Magnetic Pencil Proximity Drum Counter Sensor | link |



MA38416

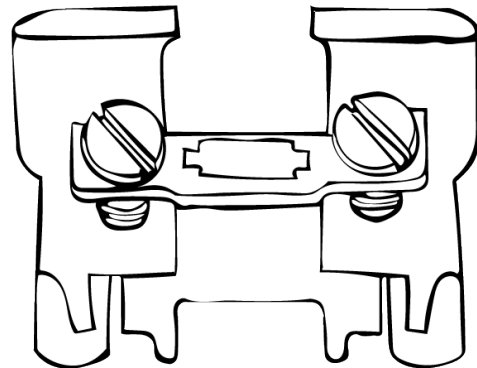

HH01182001

| PART # | DESCRIPTION | LINK |
|---------|------------------------|----------------------|
| MA38416 | Toggle Switch - Off/On | link |

| PART # | DESCRIPTION | LINK |
|------------|----------------|----------------------|
| HH01182001 | Terminal Block | link |

MM26603



MA38417



| PART # | DESCRIPTION | LINK |
|---------|--|----------------------|
| MM26603 | Half Toggle Switch Boot with Black Guard | link |

| PART # | DESCRIPTION | LINK |
|---------|---------------------------|----------------------|
| MA38417 | Toggle Switch - On/Off/On | link |

MA41464

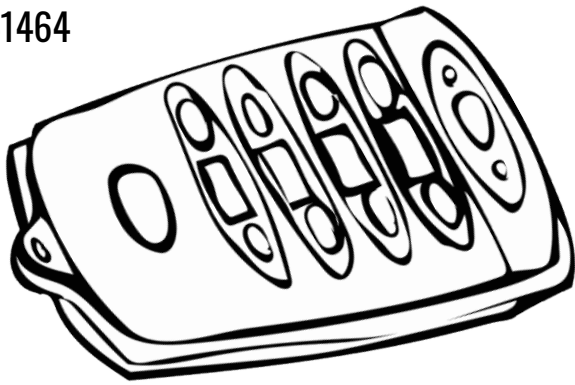

MA42100



| PART # | DESCRIPTION | LINK |
|---------|----------------------------------|----------------------|
| MA41464 | Remote Control Radio Transmitter | link |

| PART # | DESCRIPTION | LINK |
|---------|------------------------------|----------------------|
| MA42100 | Omnex Receiver, R160, 2.4GHZ | link |



HH01168001

| PART # | DESCRIPTION | LINK |
|------------|--|----------------------|
| HH01168001 | 2.5in Open Back Recess Mount Light Grommet | link |



HH01217001

| PART # | DESCRIPTION | LINK |
|------------|---------------|----------------------|
| HH01217001 | LED Light Kit | link |

HH01086011



| PART # | DESCRIPTION | LINK |
|------------|-------------------------------|----------------------|
| HH01086011 | 4in Rubber Light Lamp Grommet | link |



HH01086008

| PART # | DESCRIPTION | LINK |
|------------|-----------------------------|----------------------|
| HH01086008 | Red Grommet Mount LED Light | link |

HH011670009

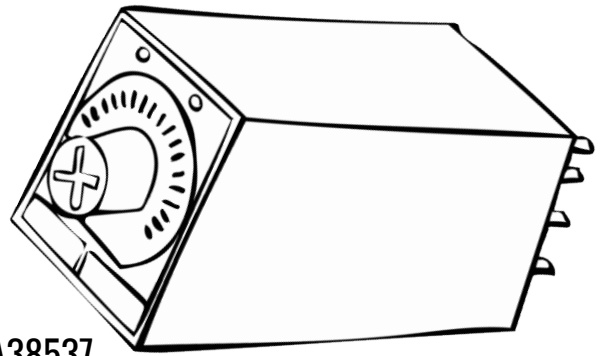

MA38537

| PART # | DESCRIPTION | LINK | PART # | DESCRIPTION | LINK |
|------------|-------------------------------------|----------------------|---------|------------------|----------------------|
| HH01167009 | 2.5in Red Incandescent Marker Light | link | MA38537 | Time Delay Relay | link |

0085283

no pic

0110123



| PART # | DESCRIPTION | LINK |
|---------|---------------------------|----------------------|
| 0085283 | Air Hopper Monitor Switch | link |

| PART # | DESCRIPTION | LINK |
|---------|------------------------|----------------------|
| 0110123 | 15 AMP Circuit Breaker | link |



0082986



0110195

| PART # | DESCRIPTION | LINK |
|---------|------------------------|----------------------|
| 0082986 | Coil for Delta Remotes | link |

| PART # | DESCRIPTION | LINK |
|---------|------------------------------------|----------------------|
| 0110195 | On Off Toggle Switch With Pigtails | link |



0016977

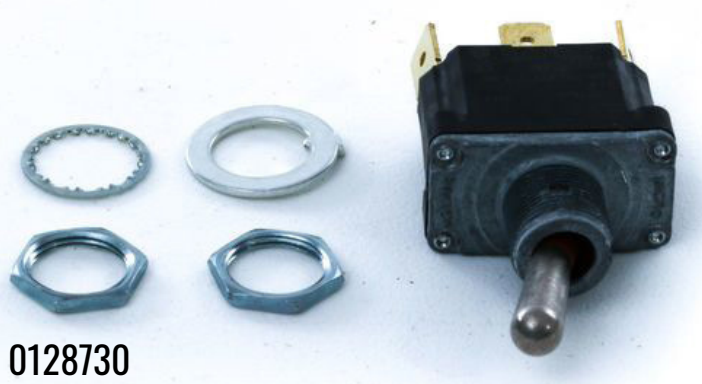

0128730

| PART # | DESCRIPTION | LINK |
|---------|-----------------|----------------------|
| 0016977 | Electric Switch | link |

| PART # | DESCRIPTION | LINK |
|---------|-----------------------|----------------------|
| 0128730 | On/ Off Toggle Switch | link |

0082492

no pic

0082433



| PART # | DESCRIPTION | LINK |
|---------|---------------|----------------------|
| 0082492 | Toggle Switch | link |

| PART # | DESCRIPTION | LINK |
|---------|---------------------------|----------------------|
| 0082433 | Toggle Switch - On-Off-On | link |

0110209



0082446

| PART # | DESCRIPTION | LINK |
|---------|---------------|----------------------|
| 0110209 | Toggle Switch | link |

| PART # | DESCRIPTION | LINK |
|---------|-----------------------------|----------------------|
| 0082446 | 2-Position Momentary Switch | link |

0016979



1166275



| PART # | DESCRIPTION | LINK |
|---------|--------------------------|----------------------|
| 0016979 | Electrical Toggle Switch | link |

| PART # | DESCRIPTION | LINK |
|---------|-------------------------------------|----------------------|
| 1166275 | On Off Toggle Switch With Pigtailed | link |

0085693



0189136



| PART # | DESCRIPTION | LINK |
|---------|--|----------------------|
| 0085693 | Black Dipped Toggle Switch with Pigtails | link |

| PART # | DESCRIPTION | LINK |
|---------|------------------------------------|----------------------|
| 0189136 | 3 Position Momentary Toggle Switch | link |

0082491

no pic



| PART # | DESCRIPTION | LINK |
|---------|--|----------------------|
| 0082491 | Self Center Toggle Switch Without Pigtails | link |

| PART # | DESCRIPTION | LINK |
|---------|-------------------------------------|----------------------|
| 0110205 | Strain Relief with Flex Tail - 0.75 | link |

0110124



0110172



| PART # | DESCRIPTION | LINK |
|---------|--------------------|----------------------|
| 0110124 | Chute Hazard Light | link |

| PART # | DESCRIPTION | LINK |
|---------|---|----------------------|
| 0110172 | 3-Wire Proximity Switch With Weather Pack Connector | link |

0126137



1539595



| PART # | DESCRIPTION | LINK |
|---------|---------------------------------|----------------------|
| 0126137 | Hydraulic Chute Pressure Switch | link |

| PART # | DESCRIPTION | LINK |
|---------|---------------------------------------|----------------------|
| 1539595 | 32in 4 Wire Proximity Switch Assembly | link |

0110112



| PART # | DESCRIPTION | LINK |
|---------|---|----------------------|
| 0110112 | Rocker Switch for BridgeMaster Interlock - On Off Momentary | link |

0110113



| PART # | DESCRIPTION | LINK |
|---------|--|----------------------|
| 0110113 | Rocker Switch-Self Centering BM Up/ Down | link |

0110251



| PART # | DESCRIPTION | LINK |
|---------|--|----------------------|
| 0110251 | Start Stop Rocker Switch - Mid Position Bridgemaster | link |

0110114



| PART # | DESCRIPTION | LINK |
|---------|--------------------------------|----------------------|
| 0110114 | Rocker Switch - On Off Red Red | link |

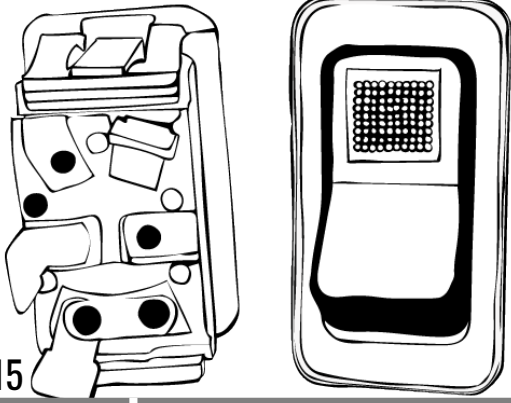

0110115

0110116



| PART # | DESCRIPTION | LINK |
|---------|-------------------------------|----------------------|
| 0110115 | Rocker Switch for Work Lights | link |

| PART # | DESCRIPTION | LINK |
|---------|---|----------------------|
| 0110116 | Rocker Switch for Cooler Fan - On Off Red | link |



0110250



0110254

| PART # | DESCRIPTION | LINK |
|---------|---------------|----------------------|
| 0110250 | Rocker Switch | link |

| PART # | DESCRIPTION | LINK |
|---------|----------------------------------|----------------------|
| 0110254 | Work Light Rocker With Engraving | link |



0110259



0110255

| PART # | DESCRIPTION | LINK |
|---------|--------------------------------------|----------------------|
| 0110259 | Activate Bridge Master Rocker Switch | link |

| PART # | DESCRIPTION | LINK |
|---------|-----------------------------|----------------------|
| 0110255 | Paddle Switch-Chute Up/Down | link |

0110256



0110257



| PART # | DESCRIPTION | LINK |
|--------|-------------|------|
|--------|-------------|------|

| PART # | DESCRIPTION | LINK |
|--------|-------------|------|
|--------|-------------|------|

0110256 Paddle Switch-Charge/Discharge [link](#)

0110257 Rocker Switch-Hopper Up When Lit [link](#)



0110258



0110262

| PART # | DESCRIPTION | LINK |
|--------|-------------|------|
|--------|-------------|------|

| PART # | DESCRIPTION | LINK |
|--------|-------------|------|
|--------|-------------|------|

0110258 Rocker Switch - Chute Lock Unlocked When Lit [link](#)

0110262 Rocker Switch - Bridgemaster In Motion [link](#)

0110264



0110265



| PART # | DESCRIPTION | LINK |
|--------|-------------|------|
|--------|-------------|------|

| PART # | DESCRIPTION | LINK |
|--------|-------------|------|
|--------|-------------|------|

0110264 Drum Charge/Discharge Rocker Switch [link](#)

0110265 Drum Start/Stop Rocker Switch [link](#)

0189098



0189194



| PART # | DESCRIPTION | LINK |
|---------|---------------------------------|----------------------|
| 0189098 | Chute Lock Hopper Rocker Switch | link |

| PART # | DESCRIPTION | LINK |
|---------|---------------------|----------------------|
| 0189194 | Rocker Switch Bezel | link |



1142686



0128042

| PART # | DESCRIPTION | LINK |
|---------|-------------------------------------|----------------------|
| 1142686 | Momentary x Momentary Rocker Switch | link |

| PART # | DESCRIPTION | LINK |
|---------|----------------------|----------------------|
| 0128042 | On/Off Rocker Switch | link |

0189120



1145139



| PART # | DESCRIPTION | LINK |
|---------|---|----------------------|
| 0189120 | 2-Position Black Rocker Switch for Drum Control | link |

| PART # | DESCRIPTION | LINK |
|---------|--|----------------------|
| 1145139 | Red Rocker Switch Drum Start Stop with 3 Spade Terminals | link |

0128011



0110184



| PART # | DESCRIPTION | LINK |
|---------|---|----------------------|
| 0128011 | 3 Position Momentary Cab Station Switch | link |

| PART # | DESCRIPTION | LINK |
|---------|-------------------------------|----------------------|
| 0110184 | Dyna Chute Push Button Switch | link |

1427933



1103579

| PART # | DESCRIPTION | LINK |
|---------|----------------------------------|----------------------|
| 1427933 | Light Adapter Mixer Wire Harness | link |

| PART # | DESCRIPTION | LINK |
|---------|--|----------------------|
| 1103579 | Electric Rocker Switch-Bridgmaster Axle Stop | link |

0189118



0189123



| PART # | DESCRIPTION | LINK |
|---------|---------------|----------------------|
| 0189118 | Rocker Switch | link |

| PART # | DESCRIPTION | LINK |
|---------|------------------------------------|----------------------|
| 0189123 | Electric Yellow Push Button Switch | link |

0189124



| PART # | DESCRIPTION | LINK |
|---------|---------------------------------|----------------------|
| 0189124 | Electric Red Push Button Switch | link |

1102875



| PART # | DESCRIPTION | LINK |
|---------|--|----------------------|
| 1102875 | Electric Rocker Switch For Hopper and Chute Lock | link |

1103582



| PART # | DESCRIPTION | LINK |
|---------|---------------------------------|----------------------|
| 1103582 | Electric Red Push Button Switch | link |

0189119



| PART # | DESCRIPTION | LINK |
|---------|------------------------|----------------------|
| 0189119 | Chute Unlock LED Light | link |

1155959



| PART # | DESCRIPTION | LINK |
|---------|--|----------------------|
| 1155959 | Drum Discharge Button For In-Cab Pendant | link |

1155960



| PART # | DESCRIPTION | LINK |
|---------|---------------------------------------|----------------------|
| 1155960 | Constant Speed LED Push Button Switch | link |

1103584

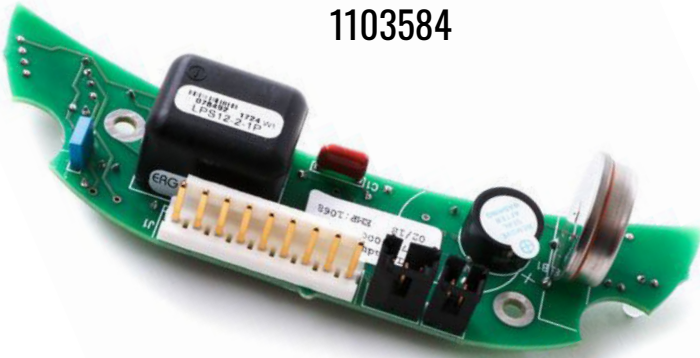

0189504



| PART # | DESCRIPTION | LINK |
|---------|------------------------------------|----------------------|
| 1103584 | Pendant PCB Counter Board Assembly | link |

| PART # | DESCRIPTION | LINK |
|---------|---|----------------------|
| 0189504 | In-Cab Fuse Box with Harness Deutsch Connection | link |



1340549

| PART # | DESCRIPTION | LINK |
|---------|---|----------------------|
| 1340549 | Magnetic Proximity Sensor Switch - Drum Counter | link |

1133813

| PART # | DESCRIPTION | LINK |
|---------|--------------------|----------------------|
| 1133813 | EP Cab Control Box | link |

1165901



| PART # | DESCRIPTION | LINK |
|---------|--------------|----------------------|
| 1165901 | Limit Switch | link |

0110082

| PART # | DESCRIPTION | LINK |
|---------|-----------------------|----------------------|
| 0110082 | Backup Alarm - 12-36V | link |

0002509



1140769



| PART # | DESCRIPTION | LINK |
|---------|----------------------------|----------------------|
| 0002509 | Constant Speed Control Box | link |

| PART # | DESCRIPTION | LINK |
|---------|-------------------------|----------------------|
| 1140769 | Quadrature Speed Sensor | link |

1181101



1103586

| PART # | DESCRIPTION | LINK |
|---------|---------------------------------------|----------------------|
| 1181101 | Control Trigger Switch and Spring Kit | link |

| PART # | DESCRIPTION | LINK |
|---------|--------------------|----------------------|
| 1103586 | Red Trigger Switch | link |

0189126



1572971



| PART # | DESCRIPTION | LINK |
|---------|---------------------------|----------------------|
| 0189126 | MX Pendant Trigger Switch | link |

| PART # | DESCRIPTION | LINK |
|---------|------------------------------------|----------------------|
| 1572971 | Proximity Switch - Chute Centering | link |

1103591



| PART # | DESCRIPTION | LINK |
|---------|----------------|----------------------|
| 1103591 | Trigger Spring | link |

1144281



| PART # | DESCRIPTION | LINK |
|---------|-------------------|----------------------|
| 1144281 | Fan Control Relay | link |

1106418

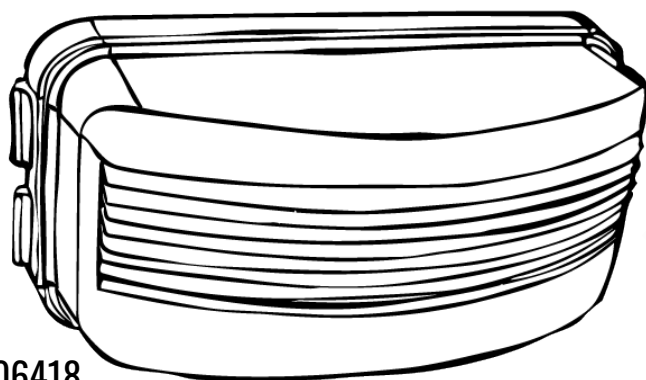

| PART # | DESCRIPTION | LINK |
|---------|--------------------|----------------------|
| 1106418 | License Light 2LED | link |



1262909

| PART # | DESCRIPTION | LINK |
|---------|--------------------|----------------------|
| 1262909 | Red LED Dash Light | link |



1178861

| PART # | DESCRIPTION | LINK |
|---------|---|----------------------|
| 1178861 | License Light 2LED .180 Bullet Conn Gray Bracket | link |

1488966

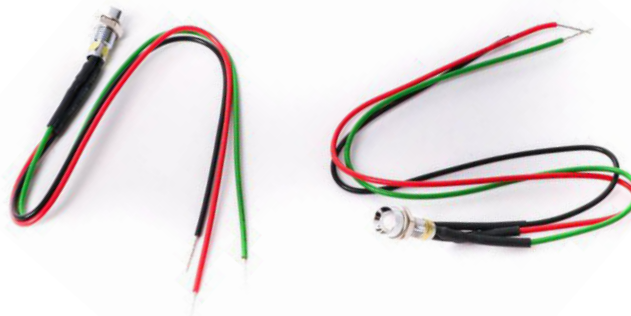

| PART # | DESCRIPTION | LINK |
|---------|------------------------------------|----------------------|
| 1488966 | 6mm 12 Volt Multi-Colored Light | link |

0128105



1275810

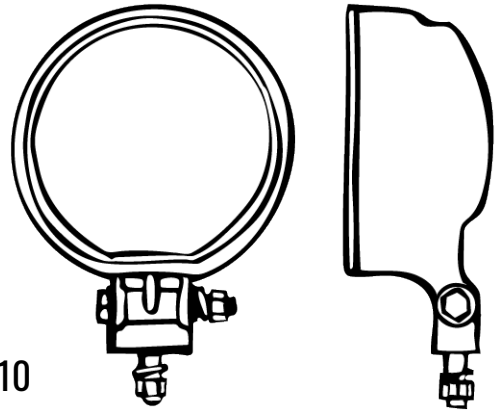

| PART # | DESCRIPTION | LINK |
|---------|-----------------------------|----------------------|
| 0128105 | Red Grommet Mount LED Light | link |

| PART # | DESCRIPTION | LINK |
|---------|------------------|----------------------|
| 1275810 | Work Light Round | link |

0189221

no pic



1138378

| PART # | DESCRIPTION | LINK |
|---------|---------------------------------------|----------------------|
| 0189221 | Wire Harness for BM Fender LED Lights | link |

| PART # | DESCRIPTION | LINK |
|---------|---------------------------------|----------------------|
| 1138378 | Wire Harness, Chassis, Main STD | link |

0128109



1550479

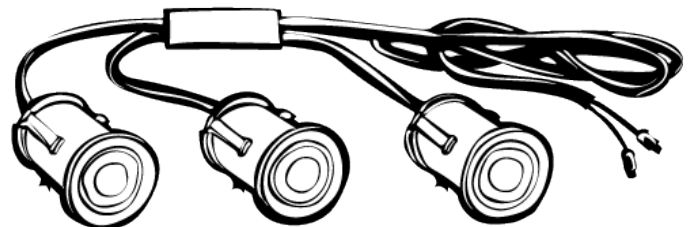

| PART # | DESCRIPTION | LINK |
|---------|---------------|----------------------|
| 0128109 | Terminal Plug | link |

| PART # | DESCRIPTION | LINK |
|---------|------------------------------|----------------------|
| 1550479 | Red Identification Light Kit | link |

1146144

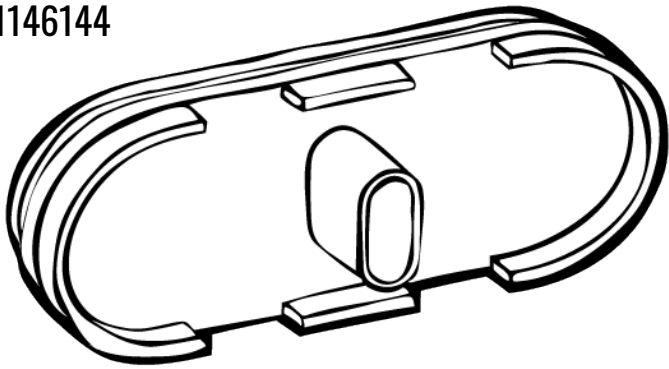

0128107



| PART # | DESCRIPTION | LINK |
|---------|---------------------------|----------------------|
| 1146144 | 10LED Red Stop/ Turn/Tail | link |

| PART # | DESCRIPTION | LINK |
|---------|-------------------------------|----------------------|
| 0128107 | LED 2.5in Red Clearance Light | link |

1147983

no pics



| PART # | DESCRIPTION | LINK |
|---------|---------------|----------------------|
| 1147983 | Red LED Light | link |

| PART # | DESCRIPTION | LINK |
|---------|-------------------------------------|----------------------|
| 0110074 | 4in Sealed Red Stop-Tail-Turn Light | link |

1232200

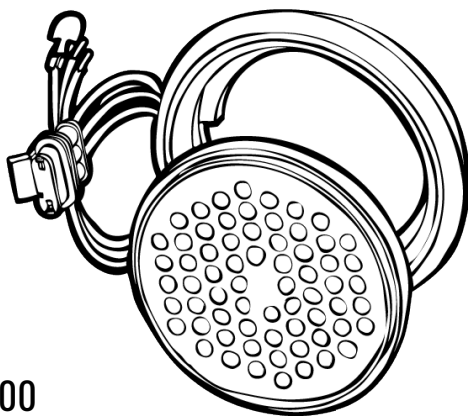

| PART # | DESCRIPTION | LINK |
|---------|-----------------------|----------------------|
| 1232200 | LED 4in Round Warning | link |

| PART # | DESCRIPTION | LINK |
|---------|---------------|----------------------|
| 0110050 | Red Reflector | link |

1238670



1165952



| PART # | DESCRIPTION | LINK | PART # | DESCRIPTION | LINK |
|---------|-----------------|----------------------|---------|---------------------------|----------------------|
| 1238670 | Amber Reflector | link | 1165952 | 2.5in Closed Back Grommet | link |

30342633



30356909



| PART # | DESCRIPTION | LINK |
|--------|-------------|------|
|--------|-------------|------|

| PART # | DESCRIPTION | LINK |
|--------|-------------|------|
|--------|-------------|------|

30342633 Electric Chute Centering Proximity Sensor [link](#)

30356909 Magnetic Proximity Sensor Switch - Drum Counter [link](#)



30356937



30356972

| PART # | DESCRIPTION | LINK |
|--------|-------------|------|
|--------|-------------|------|

| PART # | DESCRIPTION | LINK |
|--------|-------------|------|
|--------|-------------|------|

30356937 Electric Rocker Switch-On/Off With Green Backlight [link](#)

30356972 Electric Rocker Switch On/Off With Red Backlight [link](#)

30356973



30350926



| PART # | DESCRIPTION | LINK |
|--------|-------------|------|
|--------|-------------|------|

| PART # | DESCRIPTION | LINK |
|--------|-------------|------|
|--------|-------------|------|

30356973 Rocker Paddle Switch - On-Off-On [link](#)

30350926 Electric Proximity Switch with 6in Leads [link](#)

30389481



30369466



| PART # | DESCRIPTION | LINK |
|----------|--|----------------------|
| 30389481 | 2.5in Open Back Recess Mount Light Grommet | link |

| PART # | DESCRIPTION | LINK |
|----------|-----------------|----------------------|
| 30369466 | Amber LED Light | link |



30369467



30389479

| PART # | DESCRIPTION | LINK |
|----------|-------------------------|----------------------|
| 30369467 | Clearance Red LED Light | link |

| PART # | DESCRIPTION | LINK |
|----------|-------------------------------|----------------------|
| 30389479 | 4in Rubber Light Lamp Grommet | link |

303893



98385934

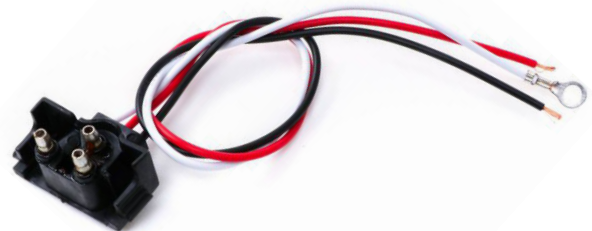

| PART # | DESCRIPTION | LINK |
|----------|-------------------------------------|----------------------|
| 30389395 | 4in Sealed Red Stop-Tail-Turn Light | link |

| PART # | DESCRIPTION | LINK |
|----------|--------------------------------|----------------------|
| 98385934 | Pigtail Harness Stop Tail Turn | link |

30369452



30369468



| PART # | DESCRIPTION | LINK | PART # | DESCRIPTION | LINK |
|----------|----------------------------------|----------------------|----------|---------------|----------------------|
| 30369452 | Fit N Forget Stop Turn Tail Plug | link | 30369468 | LED Light Kit | link |

BECK FENDERS



15960



15950

| PART # | DESCRIPTION | LINK | PART # | DESCRIPTION | LINK |
|--------|--|----------------------|--------|---|----------------------|
| 15960 | 110 x 31 x 18 Right Hand Steel Fender with Light Holes | link | 15950 | 110 x 31 x 18 Left Hand Steel Fender with Light Holes | link |

19266



| PART # | DESCRIPTION | LINK |
|--------|---------------------|----------------------|
| 19266 | Fender Impact Guard | link |

10610701



| PART # | DESCRIPTION | LINK |
|----------|---------------------------|----------------------|
| 10610701 | Mud Flap Strip for Fender | link |

90640687



| PART # | DESCRIPTION | LINK |
|----------|---|----------------------|
| 90640687 | 110 x 31 x 18 Left Hand Steel Fender with Light Holes | link |



90640688

| PART # | DESCRIPTION | LINK |
|----------|--|----------------------|
| 90640688 | 110 x 31 x 18 Right Hand Steel Fender with Light Holes | link |



10611700

| PART # | DESCRIPTION | LINK |
|----------|-----------------------------|----------------------|
| 10611700 | White Poly Plastic Mud Flap | link |

90648100



| PART # | DESCRIPTION | LINK |
|----------|---------------------------------------|----------------------|
| 90648100 | 110in Steel Universal Flat Top Fender | link |



90648003

| PART # | DESCRIPTION | LINK |
|----------|--|----------------------|
| 90648003 | Single Light Hole Steel Universal LH Fender Dovetail | link |

CONTINENTAL FENDERS



90648004

90648001

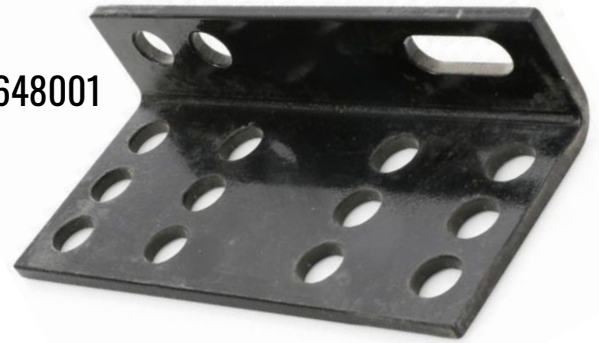

| PART # | DESCRIPTION | LINK |
|----------|--|----------------------|
| 90648004 | Single Light Hole Steel Universal RH Fender Dovetail | link |

| PART # | DESCRIPTION | LINK |
|----------|----------------------------------|----------------------|
| 90648001 | Fender Mount Steel Angle Bracket | link |

90648005



| PART # | DESCRIPTION | LINK |
|----------|--|----------------------|
| 90648005 | Universal Fender Left Hand Front Bracket | link |

90648006



| PART # | DESCRIPTION | LINK |
|----------|---|----------------------|
| 90648006 | Universal Fender Right Hand Front Bracket | link |

80640135



| PART # | DESCRIPTION | LINK |
|--------|-------------|------|
|--------|-------------|------|

80640135 Fender Front Support Right Hand Steel

[link](#)

80640035



| PART # | DESCRIPTION | LINK |
|--------|-------------|------|
|--------|-------------|------|

80640035 Fender Front Support Left Hand Steel

[link](#)

80640032



80640070

no pic

| PART # | DESCRIPTION | LINK | PART # | DESCRIPTION | LINK |
|--------|-------------|------|--------|-------------|------|
|--------|-------------|------|--------|-------------|------|

80640032 107in Steel Fender Blank

[link](#)

80640070

Fender Blank, 70in LH Steel Pusher

[link](#)

CONTINENTAL FENDERS

90648200

no pic

90643302



| PART # | DESCRIPTION | LINK |
|----------|-----------------------|----------------------|
| 90648200 | 110in Flat Top Fender | link |

| PART # | DESCRIPTION | LINK |
|----------|--|----------------------|
| 90643302 | LH Dovetail Fender Support Aluminum 3 Light Hole | link |



90643312

| PART # | DESCRIPTION | LINK |
|----------|--|----------------------|
| 90643312 | RH Dovetail Fender Support Aluminum 3 Light Hole | link |

90648031

| PART # | DESCRIPTION | LINK |
|----------|----------------------------|----------------------|
| 90648031 | LH Dovetail Fender Support | link |

90648032



90640017



| PART # | DESCRIPTION | LINK |
|----------|----------------------------|----------------------|
| 90648032 | RH Dovetail Fender Support | link |

| PART # | DESCRIPTION | LINK |
|----------|--|----------------------|
| 90640017 | Universal Booster Axle Fender - LH Plastic | link |

CONTINENTAL FENDERS

90640018



90640019



| PART # | DESCRIPTION | LINK |
|--------|-------------|------|
|--------|-------------|------|

90640018 Universal Booster Axle Fender - RH Plastic [link](#)

| PART # | DESCRIPTION | LINK |
|--------|-------------|------|
|--------|-------------|------|

90640019 Left Side Axle Fender Mounting Bracket [link](#)



90640020



90640040

| PART # | DESCRIPTION | LINK |
|--------|-------------|------|
|--------|-------------|------|

90640020 Right Side Axle Fender Mounting Bracket [link](#)

| PART # | DESCRIPTION | LINK |
|--------|-------------|------|
|--------|-------------|------|

90640040 Left Side Bridgesaver Axle Fender Mounting Bracket [link](#)



90640041

| PART # | DESCRIPTION | LINK |
|--------|-------------|------|
|--------|-------------|------|

90640041 Right Side Bridgesaver Axle Fender Mounting Bracket [link](#)



10500135

| PART # | DESCRIPTION | LINK |
|--------|-------------|------|
|--------|-------------|------|

10500135 Fender Chute Mount Bracket [link](#)

CONTINENTAL FENDERS

80640334



80640234



| PART # | DESCRIPTION | LINK |
|----------|-----------------------------|----------------------|
| 80640334 | Right Hand Steel Fender Cap | link |

| PART # | DESCRIPTION | LINK |
|----------|----------------------------|----------------------|
| 80640234 | Left Hand Steel Fender Cap | link |

90640034



90640033

| PART # | DESCRIPTION | LINK |
|----------|---|----------------------|
| 90640034 | RH Hendrickson Axle Fender Mounting Bracket | link |

| PART # | DESCRIPTION | LINK |
|----------|---|----------------------|
| 90640033 | LH Hendrickson Axle Fender Mounting Bracket | link |

90649048



90649047



| PART # | DESCRIPTION | LINK |
|----------|--------------------------------|----------------------|
| 90649048 | LH Tag Fender Mounting Bracket | link |

| PART # | DESCRIPTION | LINK |
|----------|--------------------------------|----------------------|
| 90649047 | RH Tag Fender Mounting Bracket | link |



| PART # | DESCRIPTION | LINK |
|--------|--|----------------------|
| 205001 | 107in Steel Flat Top Fender Blank | link |
| 205080 | 107in Aluminum Flat Top Fender Blank | link |
| 205060 | 70in Steel Flat Top Fender Blank Left Hand | link |
| 205061 | 70in Steel Flat Top Fender Blank Right Hand | link |
| 205082 | 70in Aluminum Flat Top Fender Blank Left Hand | link |
| 205081 | 70in Aluminum Flat Top Fender Blank Right Hand | link |
| 205095 | 120in Steel Flat Top Fender Blank | link |
| 205085 | 120in Aluminum Flat Top Fender Blank | link |

205003



205055



| PART # | DESCRIPTION | LINK | PART # | DESCRIPTION | LINK |
|--------|----------------------------|----------------------|--------|---------------------------------------|----------------------|
| 205003 | Left Hand Steel Fender Cap | link | 205055 | Aluminum Dovetail Fender Support - LH | link |

CON-TECH FENDERS

205002



| PART # | DESCRIPTION | LINK |
|--------|-----------------------------|----------------------|
| 205002 | Right Hand Steel Fender Cap | link |



205043

| PART # | DESCRIPTION | LINK |
|--------|---------------------------------------|----------------------|
| 205043 | Aluminum Dovetail Fender Support - RH | link |



205014

| PART # | DESCRIPTION | LINK |
|--------|--------------------------------------|----------------------|
| 205014 | Fender Front Support Left Hand Steel | link |



205051

| PART # | DESCRIPTION | LINK |
|--------|-------------------------------|----------------------|
| 205051 | Aluminum Support Bracket - LH | link |



205013

| PART # | DESCRIPTION | LINK |
|--------|---------------------------------------|----------------------|
| 205013 | Fender Front Support Right Hand Steel | link |



205050

| PART # | DESCRIPTION | LINK |
|--------|-------------------------------|----------------------|
| 205050 | Aluminum Support Bracket - RH | link |

CON-TECH FENDERS

205016



205015



| PART # | DESCRIPTION | LINK |
|--------|---------------------|----------------------|
| 205016 | Fender Center Strap | link |

| PART # | DESCRIPTION | LINK |
|--------|---------------------|----------------------|
| 205015 | Fender Center Brace | link |

205017

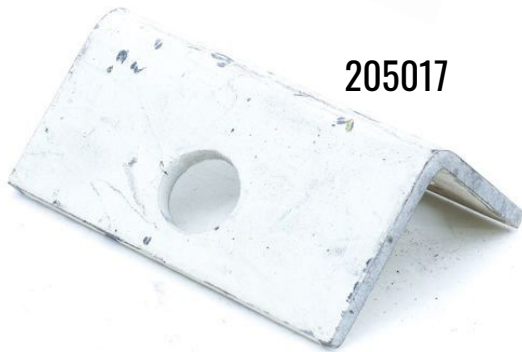

| PART # | DESCRIPTION | LINK |
|--------|---------------------------|----------------------|
| 205017 | Fender Center Brace Angle | link |

| PART # | DESCRIPTION | LINK |
|--------|--|----------------------|
| 730014 | Fender Cushion End Rubber, Bracket Cushion | link |

730026



705000



| PART # | DESCRIPTION | LINK |
|--------|-----------------------|----------------------|
| 730026 | Fender Cushion Center | link |

| PART # | DESCRIPTION | LINK |
|--------|----------------------------------|----------------------|
| 705000 | Large Rubber Backed Steel Washer | link |

285130



| PART # | DESCRIPTION | LINK |
|--------|--------------------|----------------------|
| 285130 | Mud Flap Stiffener | link |

205018



| PART # | DESCRIPTION | LINK |
|--------|---------------------------|----------------------|
| 205018 | Mud Flap Strip for Fender | link |

600175

no pic

| PART # | DESCRIPTION | LINK |
|--------|------------------------------|----------------------|
| 600175 | Left Hand BK Fender Assembly | link |

no pic

600176

| PART # | DESCRIPTION | LINK |
|--------|-------------------------------|----------------------|
| 600176 | Right Hand BK Fender Assembly | link |

245116



| PART # | DESCRIPTION | LINK |
|--------|---------------------------------------|----------------------|
| 245116 | Left Hand Bridge King Tag Axle Fender | link |

245115

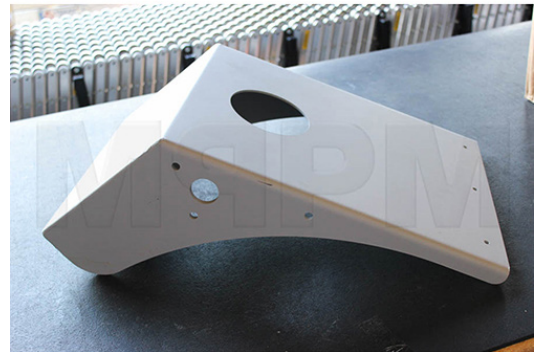

| PART # | DESCRIPTION | LINK |
|--------|--|----------------------|
| 245115 | Right Hand Bridge King Tag Axle Fender | link |

CON-TECH FENDERS

790102



790100



| PART # | DESCRIPTION | LINK |
|--------|-------------------------|----------------------|
| 790102 | LH Bridge King V Fender | link |

| PART # | DESCRIPTION | LINK |
|--------|---|----------------------|
| 790100 | 80 Degree Right Hand Bridge King Fender | link |

730045

no pic

no pic

730043

| PART # | DESCRIPTION | LINK |
|--------|----------------------------|----------------------|
| 730045 | 30in x 24in Rubber Mudflap | link |

| PART # | DESCRIPTION | LINK |
|--------|-----------------------------|----------------------|
| 730043 | Mudflap - BridgeKing Fender | link |

730041



245379



| PART # | DESCRIPTION | LINK |
|--------|-----------------------------------|----------------------|
| 730041 | White Poly Mud Flap - 24in x 24in | link |

| PART # | DESCRIPTION | LINK |
|--------|-----------------------------------|----------------------|
| 245379 | Rear Step Bumper Mounting Bracket | link |

285985

no pic

245380



| PART # | DESCRIPTION | LINK |
|--------|-------------|------|
|--------|-------------|------|

285985 Rear Step Bumper Bar Channel - Bolt-On Steps [link](#)

| PART # | DESCRIPTION | LINK |
|--------|-------------|------|
|--------|-------------|------|

245380 Rear Step Bumper Bolt-On Steps [link](#)



285013



285024

| PART # | DESCRIPTION | LINK |
|--------|-------------|------|
|--------|-------------|------|

285013 Bolt On Bumper Bracket [link](#)

| PART # | DESCRIPTION | LINK |
|--------|-------------|------|
|--------|-------------|------|

285024 Fender Chute Mount Bracket [link](#)

19289



H11579



| PART # | DESCRIPTION | LINK |
|--------|---------------------------|----------------------|
| 19289 | Mud Flap Strip for Fender | link |

| PART # | DESCRIPTION | LINK |
|--------|---------------------------|----------------------|
| H11579 | Heavy Duty 24x24 Mud Flap | link |

18789



18790



| PART # | DESCRIPTION | LINK |
|--------|---------------------------------------|----------------------|
| 18789 | Right Hand Plastic Bridge Axle Fender | link |

| PART # | DESCRIPTION | LINK |
|--------|--------------------------------------|----------------------|
| 18790 | Left Hand Plastic Bridge Axle Fender | link |

25133



25134



| PART # | DESCRIPTION | LINK |
|--------|-----------------------|----------------------|
| 25133 | Fender Retainer Plate | link |

| PART # | DESCRIPTION | LINK |
|--------|--------------------------------|----------------------|
| 25134 | Right Hand Tube for Tag Fender | link |

25135



| PART # | DESCRIPTION | LINK |
|--------|------------------------------|----------------------|
| 25135 | Left Hand Bridge Fender Tube | link |

MB4081501

| PART # | DESCRIPTION | LINK |
|-----------|--|----------------------|
| MB4081501 | Universal Booster Axle Fender - LH Plastic | link |

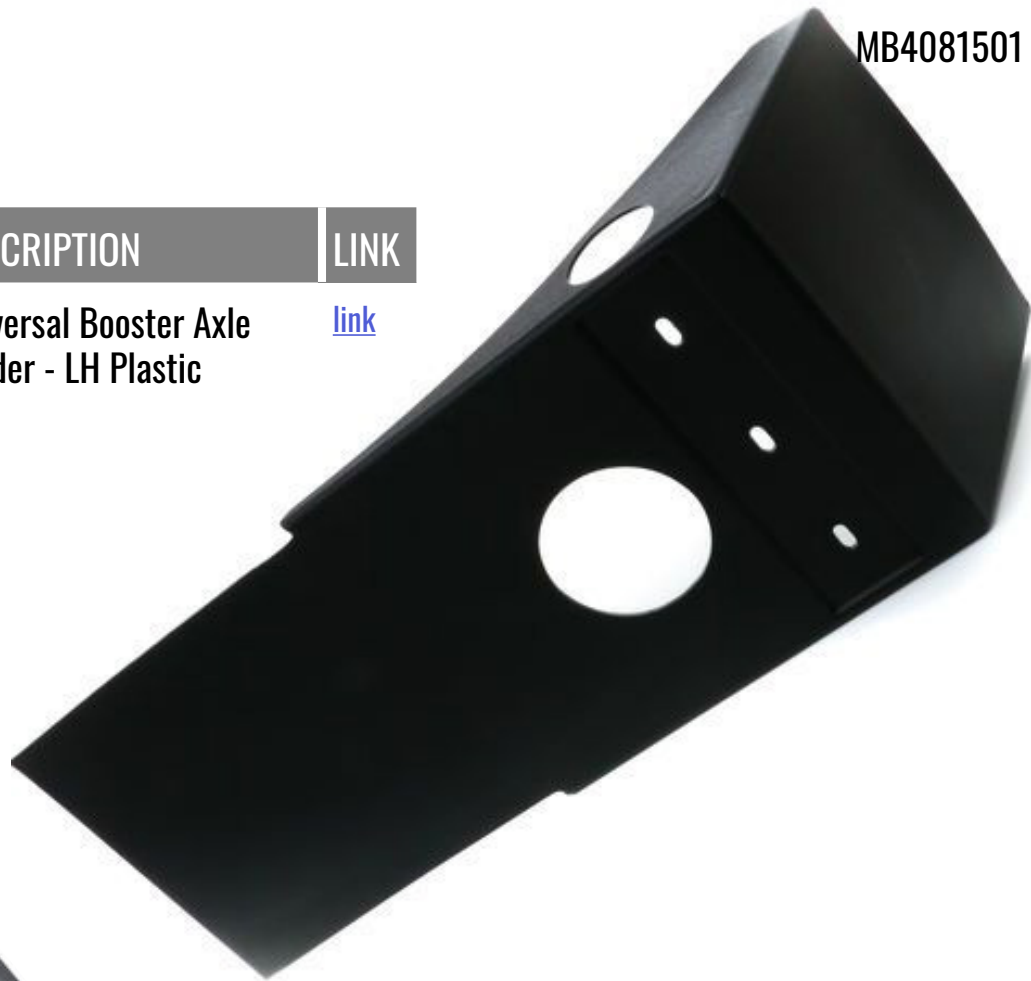

| PART # | DESCRIPTION | LINK |
|-----------|--|----------------------|
| MB4081502 | Universal Booster Axle Fender - RH Plastic | link |

MB4081502



MCNEILUS FENDERS



| PART # | DESCRIPTION | LINK |
|---------|-----------------------------------|----------------------|
| 0152749 | 107in Steel Fender Blank | link |
| 1147503 | 70in LH Steel Pusher Fender Blank | link |
| 1147505 | 70in RH Steel Pusher Fender Blank | link |
| 0152846 | 120in Steel Fender Blank | link |
| 0153204 | 120in Aluminum Flat Top Fender | link |



0153203

1147514

no pic

| PART # | DESCRIPTION | LINK | PART # | DESCRIPTION | LINK |
|---------|-----------------------------------|----------------------|---------|--------------------------------------|----------------------|
| 0153203 | Aluminum Flat Top Fender 107in | link | 1147514 | Pusher Fender - Aluminum - 70" LH | link |

MCNEILUS FENDERS

1147504

no pic

0183715

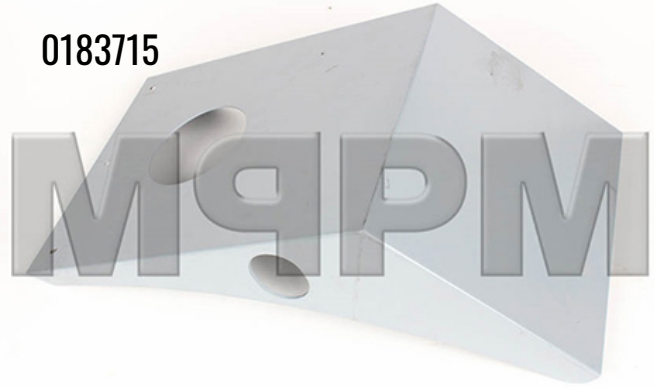

| PART # | DESCRIPTION | LINK |
|---------|-----------------------------------|----------------------|
| 1147504 | Pusher Fender - Aluminum - 70" RH | link |

| PART # | DESCRIPTION | LINK |
|---------|------------------------|----------------------|
| 0183715 | BM Trailer Fender - LH | link |

0183710

| PART # | DESCRIPTION | LINK |
|---------|------------------------|----------------------|
| 0183710 | BM Trailer Fender - RH | link |

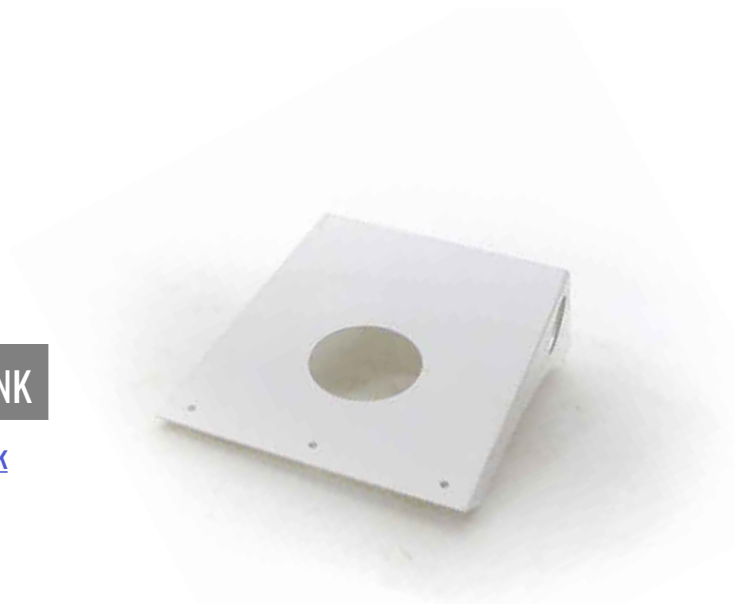

0152001

0152000



| PART # | DESCRIPTION | LINK |
|---------|--------------------------------------|----------------------|
| 0152001 | Fender Front Support Left Hand Steel | link |

| PART # | DESCRIPTION | LINK |
|---------|---------------------------------------|----------------------|
| 0152000 | Fender Front Support Right Hand Steel | link |

MCNEILUS FENDERS

1545644

no pic

0183718



| PART # | DESCRIPTION | LINK |
|---------|---------------------------------|----------------------|
| 1545644 | Right Hand Front Fender Support | link |

| PART # | DESCRIPTION | LINK |
|---------|-----------------------------|----------------------|
| 0183718 | BM Trailer Fender Tube - LH | link |

0183717



| PART # | DESCRIPTION | LINK |
|---------|-----------------------------|----------------------|
| 0183717 | BM Trailer Fender Tube - RH | link |

| PART # | DESCRIPTION | LINK |
|---------|-----------------------------------|----------------------|
| 0189030 | BMV RH Fender Mount Weldment Tube | link |

0189030

0189035



1474630

| PART # | DESCRIPTION | LINK |
|---------|-----------------------------------|----------------------|
| 0189035 | BMV LH Fender Mount Weldment Tube | link |

| PART # | DESCRIPTION | LINK |
|---------|--------------------------------------|----------------------|
| 1474630 | Bracket, BMV Fender Mount, RH Gen II | link |

MCNEILUS FENDERS

1474631



1486067



| PART # | DESCRIPTION | LINK |
|--------|-------------|------|
|--------|-------------|------|

| PART # | DESCRIPTION | LINK |
|--------|-------------|------|
|--------|-------------|------|

1474631 Bracket, BMV Fender Mount, LH Gen II [link](#)

1486067 RH Bridgemaster Gen II Fender Tube [link](#)



1486066



1486203

| PART # | DESCRIPTION | LINK |
|--------|-------------|------|
|--------|-------------|------|

| PART # | DESCRIPTION | LINK |
|--------|-------------|------|
|--------|-------------|------|

1486066 LH Bridgemaster Gen II Fender Tube [link](#)

1486203 BMV RH Fender Mount Weldment Tube [link](#)



1486202

1545593



| PART # | DESCRIPTION | LINK |
|--------|-------------|------|
|--------|-------------|------|

| PART # | DESCRIPTION | LINK |
|--------|-------------|------|
|--------|-------------|------|

1486202 BMV LH Fender Mount Weldment Tube [link](#)

1545593 Left Hand Steel Fender Cap [link](#)

MCNEILUS FENDERS

1545590



1486066



| PART # | DESCRIPTION | LINK |
|--------|-------------|------|
|--------|-------------|------|

| | | |
|---------|-----------------------------|----------------------|
| 1545590 | Right Hand Steel Fender Cap | link |
|---------|-----------------------------|----------------------|

| PART # | DESCRIPTION | LINK |
|--------|-------------|------|
|--------|-------------|------|

| | | |
|---------|------------------------------------|----------------------|
| 1486066 | LH Bridgemaster Gen II Fender Tube | link |
|---------|------------------------------------|----------------------|

1485081



1545583



| PART # | DESCRIPTION | LINK |
|--------|-------------|------|
|--------|-------------|------|

| | | |
|---------|----------------------------|----------------------|
| 1485081 | Left Hand Steel Fender Cap | link |
|---------|----------------------------|----------------------|

| PART # | DESCRIPTION | LINK |
|--------|-------------|------|
|--------|-------------|------|

| | | |
|---------|---|----------------------|
| 1545583 | Fender Support-Rear Right Hand Aluminum | link |
|---------|---|----------------------|

1545589



1545608



| PART # | DESCRIPTION | LINK |
|--------|-------------|------|
|--------|-------------|------|

| | | |
|---------|--|----------------------|
| 1545589 | Fender Support-Rear Left Hand Aluminum | link |
|---------|--|----------------------|

| PART # | DESCRIPTION | LINK |
|--------|-------------|------|
|--------|-------------|------|

| | | |
|---------|--|----------------------|
| 1545608 | 2 Hole Right Hand Aluminum Fender Support Weldment | link |
|---------|--|----------------------|

MCNEILUS FENDERS

1545613



0152717



| PART # | DESCRIPTION | LINK |
|---------|---|----------------------|
| 1545613 | 2 Hole Left Hand Aluminum Fender Support Weldment | link |

| PART # | DESCRIPTION | LINK |
|---------|---------------------|----------------------|
| 0152717 | Fender Center Brace | link |

0084604



0084007

| PART # | DESCRIPTION | LINK |
|---------|---------------------|----------------------|
| 0084604 | Fender Center Strap | link |

| PART # | DESCRIPTION | LINK |
|---------|---------------------------|----------------------|
| 0084007 | Fender Center Brace Angle | link |

0082652



0084336



| PART # | DESCRIPTION | LINK |
|---------|---------------------------|----------------------|
| 0082652 | Mud Flap Strip for Fender | link |

| PART # | DESCRIPTION | LINK |
|---------|--|----------------------|
| 0084336 | Fender Cushion End Rubber, Bracket Cushion | link |

MCNEILUS FENDERS

0084391



1235060



| PART # | DESCRIPTION | LINK |
|---------|-----------------------|----------------------|
| 0084391 | Fender Cushion Center | link |

| PART # | DESCRIPTION | LINK |
|---------|--|----------------------|
| 1235060 | 80 Degree Right Hand Bridgemaster Fender | link |



1235061



0183738

| PART # | DESCRIPTION | LINK |
|---------|--------------------------|----------------------|
| 1235061 | LH Bridgemaster V Fender | link |

| PART # | DESCRIPTION | LINK |
|---------|---------------------------|----------------------|
| 0183738 | Plastic Fender RH Bracket | link |



0183740

| PART # | DESCRIPTION | LINK |
|---------|---------------------------------|----------------------|
| 0183740 | Plastic Fender Retainer Bracket | link |

SCHWING FENDERS

30389911



30389912



| PART # | DESCRIPTION | LINK |
|--------|-------------|------|
|--------|-------------|------|

| PART # | DESCRIPTION | LINK |
|--------|-------------|------|
|--------|-------------|------|

30389911 Fender Rear Support End - RH Curbside [link](#)

30389912 Fender Rear Support End - LH Roadside [link](#)

98386850



98386983

| PART # | DESCRIPTION | LINK |
|--------|-------------|------|
|--------|-------------|------|

| PART # | DESCRIPTION | LINK |
|--------|-------------|------|
|--------|-------------|------|

98386850 Mud Flap Strip for Fender [link](#)

98386983 24in x 24in White Plastic Mudflap [link](#)

98397136



98397142



| PART # | DESCRIPTION | LINK |
|--------|-------------|------|
|--------|-------------|------|

| PART # | DESCRIPTION | LINK |
|--------|-------------|------|
|--------|-------------|------|

98397136 Left Hand Booster Fender Bracket Weldment [link](#)

98397142 Right Hand Booster Fender Bracket Weldment [link](#)

SCHWING FENDERS

30389987



98344217



| PART # | DESCRIPTION | LINK |
|----------|--------------------------------|----------------------|
| 30389987 | 20MM Washer for Fender Bracket | link |

| PART # | DESCRIPTION | LINK |
|----------|-------------------------------|----------------------|
| 98344217 | Universal Booster Axle Fender | link |

98344217AL



30389885

| PART # | DESCRIPTION | LINK |
|------------|--|----------------------|
| 98344217AL | Universal Booster Axle Fender - Aluminum | link |

| PART # | DESCRIPTION | LINK |
|----------|--------------------------|----------------------|
| 30389885 | Fender Arm - Street Side | link |

30389884

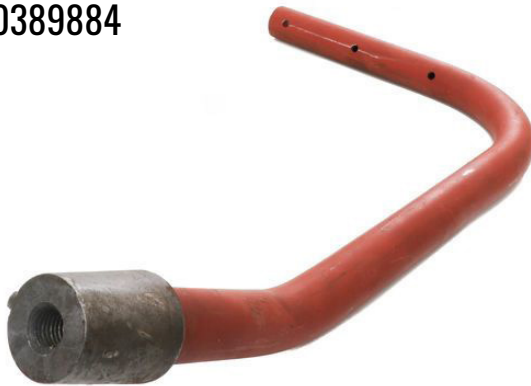

| PART # | DESCRIPTION | LINK |
|----------|------------------------|----------------------|
| 30389884 | Fender Arm - Curb Side | link |

**PAGE
INTENTIONALLY
LEFT BLANK**

BECK BIBS

45000



45000P



| PART # | DESCRIPTION | LINK |
|--------|--------------------------------------|----------------------|
| 45000 | Collector Chute-Discharge Hopper Bib | link |

| PART # | DESCRIPTION | LINK |
|--------|------------------------------|----------------------|
| 45000P | 3/16in Thick Neoprene Rubber | link |

45100

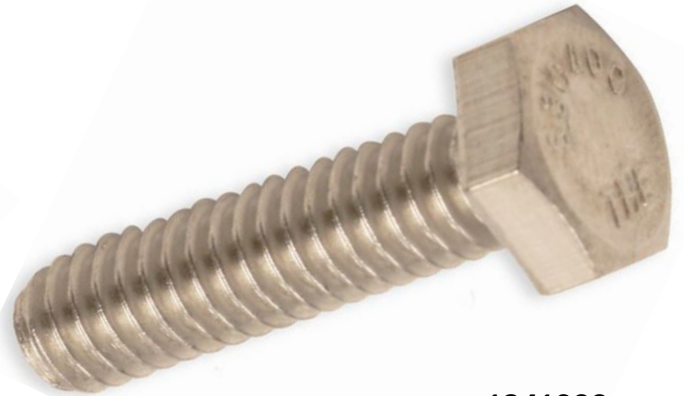

1C416SS

| PART # | DESCRIPTION | LINK |
|--------|--|----------------------|
| 45100 | Collector Chute Discharge Hopper Bib without Slits | link |

| PART # | DESCRIPTION | LINK |
|---------|-------------------------------------|----------------------|
| 1C416SS | Hex Head Cap Screw Bolt - Stainless | link |

1E04FSS



1E04SS

| PART # | DESCRIPTION | LINK |
|---------|--|----------------------|
| 1E04FSS | Washer For Installing Discharge Hopper Bib | link |

| PART # | DESCRIPTION | LINK |
|--------|----------------------------------|----------------------|
| 1E04SS | 1/4in 316 Stainless Steel Washer | link |

BECK BIBS

2E04SS



17D4N



| PART # | DESCRIPTION | LINK | PART # | DESCRIPTION | LINK |
|--------|------------------------------------|----------------------|--------|--|----------------------|
| 2E04SS | Split Lock Washer .25X.48X.07UF | link | 17D4N | Plastic Nut for Installing Collector Chute Bib Deflector | link |

CONTINENTAL BOOTS



80550425



80550136

| PART # | DESCRIPTION | LINK | PART # | DESCRIPTION | LINK |
|----------|---|----------------------|----------|--------------------------------------|----------------------|
| 80550425 | Collector Chute/Discharge Hopper Bib - No Slits | link | 80550136 | Collector Chute-Discharge Hopper Bib | link |



90550428

| PART # | DESCRIPTION | LINK |
|----------|---|----------------------|
| 90550428 | Collector Chute Discharge Hopper Bib - Long | link |

730003



730002



| PART # | DESCRIPTION | LINK |
|--------|---|----------------------|
| 730003 | Collector Chute/Discharge Hopper Bib - Poly | link |

| PART # | DESCRIPTION | LINK |
|--------|--------------------------------------|----------------------|
| 730002 | Collector Chute-Discharge Hopper Bib | link |

730060



705006

| PART # | DESCRIPTION | LINK |
|--------|--|----------------------|
| 730060 | 3/16in Thick Masticated 16in Wide x 54in Long No Slits | link |

| PART # | DESCRIPTION | LINK |
|--------|--|----------------------|
| 705006 | Flat Washer for Chute Bibs - Stainless Steel | link |

705007



705051

| PART # | DESCRIPTION | LINK |
|--------|---------------------------------|----------------------|
| 705007 | Coll Chute Bib Plastic Locknuts | link |

| PART # | DESCRIPTION | LINK |
|--------|---|----------------------|
| 705051 | Chute Bib Carriage Bolt - Stainless Steel | link |

18835



| PART # | DESCRIPTION | LINK |
|--------|--------------------------------------|----------------------|
| 18835 | Collector Chute Discharge Hopper Bib | link |

19062



| PART # | DESCRIPTION | LINK |
|--------|--|----------------------|
| 19062 | Washer For Installing Discharge Hopper Bib | link |

31202



| PART # | DESCRIPTION | LINK |
|--------|--------------------------------------|----------------------|
| 31202 | Plastic Nut for Installing Deflector | link |

KIMBLE WIPERS AND BIBS

C550258600



S080086000



| PART # | DESCRIPTION | LINK |
|------------|---------------------------------|----------------------|
| C550258600 | Collection Chute Bib Boot Clamp | link |

| PART # | DESCRIPTION | LINK |
|------------|---------------------------|----------------------|
| S080086000 | Discharge Hopper Bib Boot | link |

S420001100

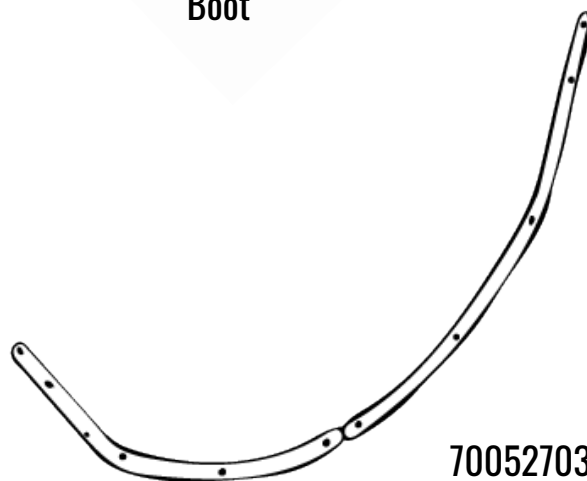

700527038

| PART # | DESCRIPTION | LINK |
|------------|--------------------------------------|----------------------|
| S420001100 | Collector Chute Discharge Hopper Bib | link |

| PART # | DESCRIPTION | LINK |
|-----------|-----------------|----------------------|
| 700527038 | Plate Collector | link |

300209005

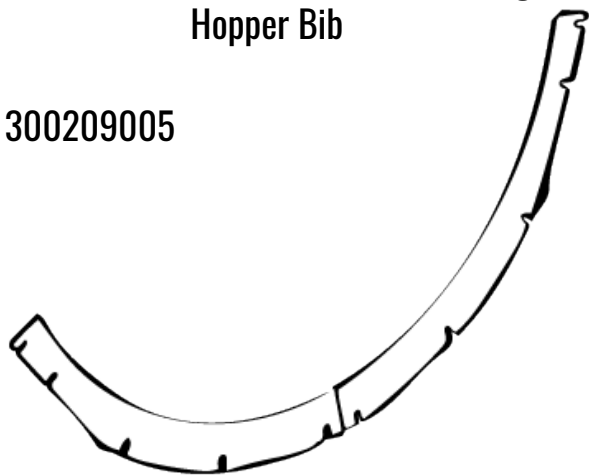

| PART # | DESCRIPTION | LINK |
|-----------|-------------|----------------------|
| 300209005 | Drum Wiper | link |

MB29376



MB40857



| PART # | DESCRIPTION | LINK | PART # | DESCRIPTION | LINK |
|---------|---|----------------------|---------|---------------------------------|----------------------|
| MB29376 | 9 Hole Collector Chute/ Discharge Hopper Bib | link | MB40857 | 3/16in Thick Neoprene Rubber | link |

MCNEILUS BIBS

1140780



115236UR



| PART # | DESCRIPTION | LINK |
|---------|---|----------------------|
| 1140780 | Collector Chute/Discharge Hopper Bib - Poly | link |

| PART # | DESCRIPTION | LINK |
|----------|---|----------------------|
| 115236UR | Red Urethane Collector Chute-Discharge Hopper Bib | link |

30389035



| PART # | DESCRIPTION | LINK |
|----------|--------------------------------------|----------------------|
| 30389035 | Collector Chute-Discharge Hopper Bib | link |

**PAGE
INTENTIONALLY
LEFT BLANK**