

Installation Information

No. 04-06-0424-EN-1000
Revised October, 2000

Replaces 04-424



Heavy Duty Series 0 and 1
Eaton® Pump Controls

RE (Remote Electric)
Control

Eaton Hydraulics

15151 Highway 5
Eden Prairie, MN 55344
Telephone: 612 937-7254
Fax: 612 937-7130
www.eatonhydraulics.com

46 New Lane, Havant
Hampshire PO9 2NB
England
Telephone: (44) 170-548-6451
Fax: (44) 170-548-7110



Table of Contents

Introduction	3
Identification of Components	4
Required Tools for Installation	4
RE (Remote Electric) Control Conversion Kits – Parts List	5,6
Dissassembly	8
Reassembly	18
Start-up and Test Procedures	33
RE Control Schematics	31, 32
Fault-Logic Troubleshooting	34, 35

Pump will work from only one control station

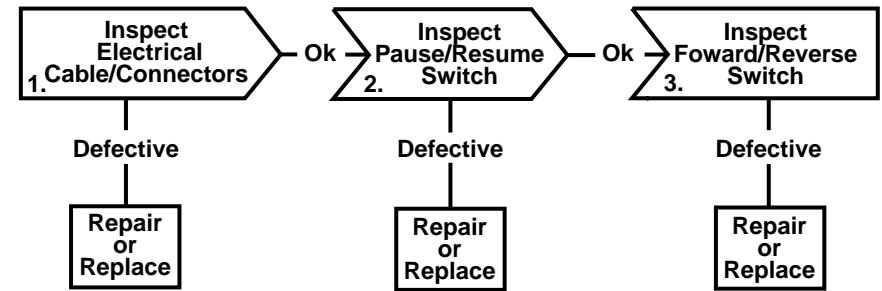

Pump will not stroke or destroke in one or both directions

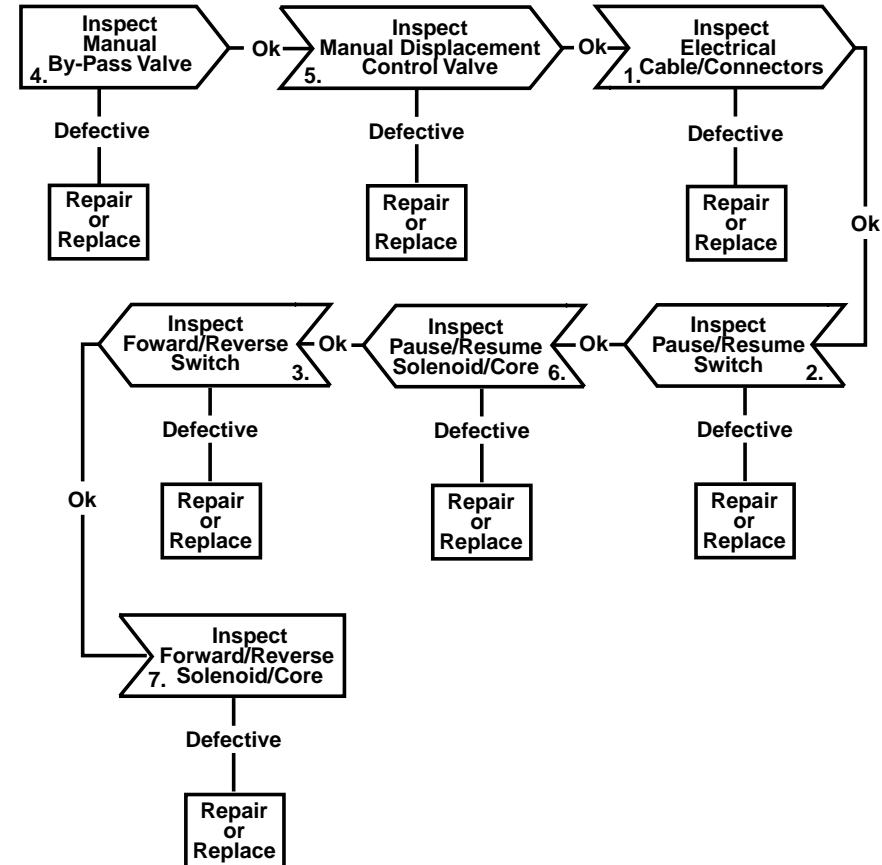

Information contained in this installation booklet is accurate as of the publication date and is subject to change without notice. Performance values are typical values. Customers are responsible for selecting products for their applications using normal engineering methods.

Fault- Logic Troubleshooting

This Fault-Logic Trouble Shooting Guide is designed as a diagnostic aid in locating possible remote electrical control problems by the user. Match the electrical control problems with the problem statements and follow the action steps in the box diagrams. This will help in correcting minor problems, eliminating unnecessary machine down time.

Following the fault-logic diagrams are diagram action comments to further help explain the action steps shown in the diagrams.

Where applicable, the action comment number of the statement appears in the action block of the diagram.

Diagram Action Step Comments

- | | |
|---|---|
| <p>1. Inspect Electrical Cable Connectors</p> <ol style="list-style-type: none"> a. Disconnected cable connector. b. Corroded connector pins. c. Broken or cut electrical cable. | <p>5. Inspect Manual Displacement Control Valve</p> <ol style="list-style-type: none"> a. Plugged control orifice. b. Damaged mounting gasket. c. Broken control connector pin. d. Broken or missing control linkage pin(s). e. Galled, stuck or bent control spool. |
| <p>2. Inspect Pause/Resume Switch</p> <ol style="list-style-type: none"> a. Corroded connector terminal. b. Defective pause/resume switch. | <p>6. Inspect Pause/Resume Solenoid/Core</p> <ol style="list-style-type: none"> a. Corroded connector pins. b. Defective Electrical Solenoid. c. Defective Solenoid core. |
| <p>3. Inspect Forward/Reverse Switch</p> <ol style="list-style-type: none"> a. Corroded connector terminal. b. Defective forward/reverse switch. | <p>7. Inspect Forward/Reverse Solenoids/Core</p> <ol style="list-style-type: none"> a. Corroded connector pins. b. Defective Electrical Solenoid. c. Defective Solenoid core. |
| <p>4. Inspect Manual By-Pass Valve</p> <ol style="list-style-type: none"> a. Manual by-pass valve in partial or open position. | |

Explanatory Diagram

Symptom:

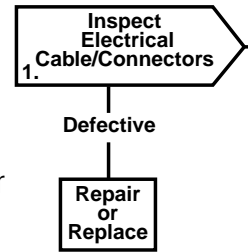

Introduction

The following information describes the installation of the Eaton® RE Control on Heavy Duty Series 0 and 1 hydrostatic pumps. Review this information to become familiar with the procedures required before beginning any installation.

CAUTION Make sure the battery is disconnected and the engine is not running. Make sure the parking brake is engaged and other peripheral equipment is disengaged.

NOTE: Hydraulic fluid can leak from the control valve assembly when removing. First shut off the hydraulic reservoir to the pump and drain the hydraulic fluid from the displacement control valve.

Identification of Components

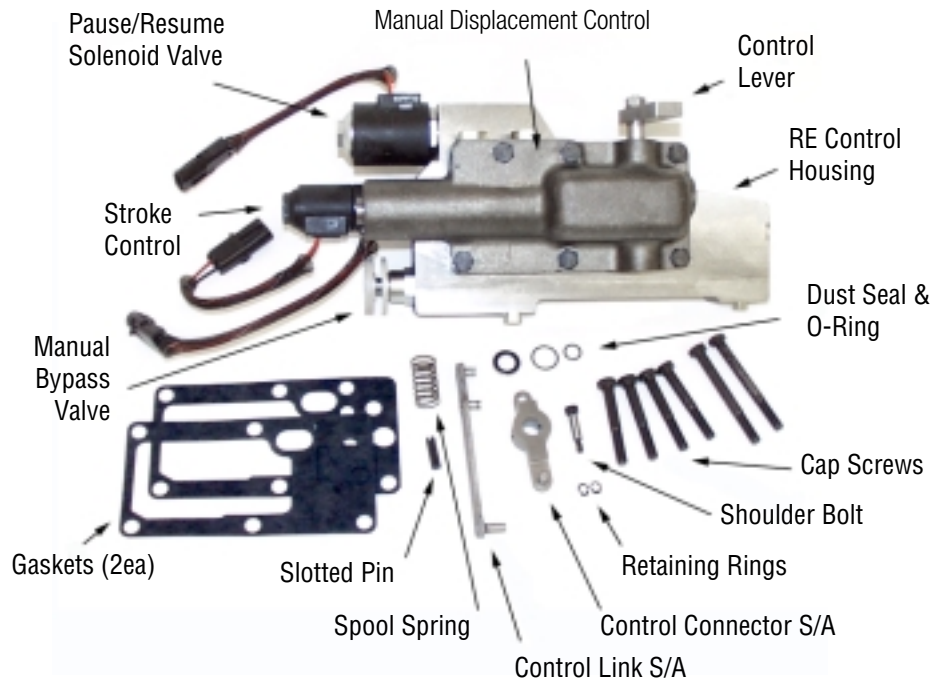

Required tools for Installation:

- 1/2 inch Socket Wrench or Open End Wrench
- Retaining Ring Pliers - Truarc® P/N 0209 or equivalent
- 3/16 inch Hex or Allen Wrench
- 3/32 inch Hex or Allen Wrench
- 1/8 inch Hex or Allen Wrench
- Small Flat Blade Screwdriver
- O-Ring Pick (dental pick)
- Petroleum Jelly (Vaseline)
- Flashlight

Start-Up and Test Procedure

CAUTION Before Starting the engine ensure all connections are reestablished, the reservoir Shut-off valve is reopened and fluid levels are within acceptable levels.

- Step 1** – Open the bypass valve by turning the adjustment knob counter clockwise.
- Step 2** – Stroke the pump by moving the control lever in both forward and backward direction to assure proper flow.
- Step 3** – a). With the pump in stroke, energize the pause/resume solenoid valve. The pump should go to neutral.
b). De-energize the pause/resume solenoid and the pump should resume stroke.
- Step 4** – Return the pump to neutral with the control lever.
- Step 5** – Close the bypass valve by turning the adjustment knob clockwise and verify pump operation by schematic below.

CAUTION: Do not attach anything to the control lever. Do not restrict the movement of the control lever. The control lever is to be used only when the bypass valve is open.

Remote Electric (RE) Control Valve Schematic

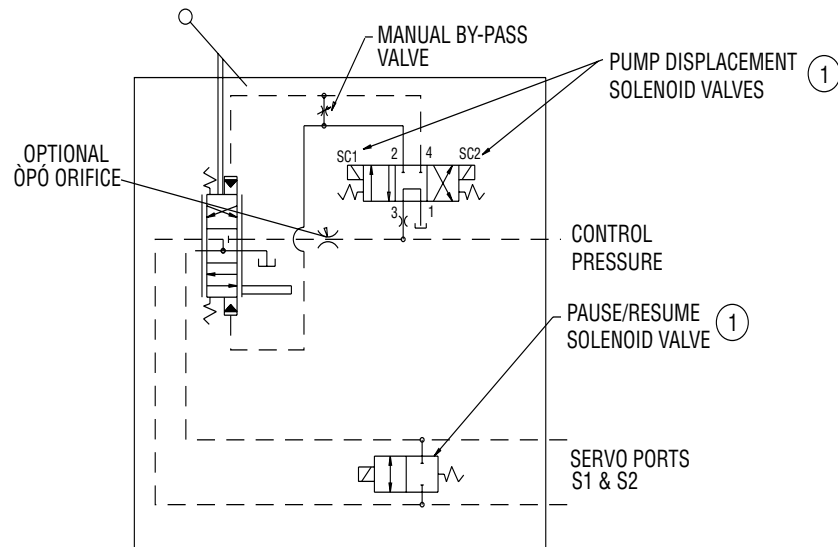

① All three coils have this schematic configuration. Coils are 12VDC 9.8 OHMS at 20°C, 1.22 AMPS initial current draw.

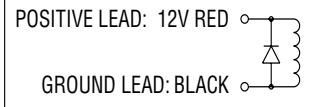

- ② Eaton Cutler Hammer 8530 K9 single pole (On-Off) switch or equivalent.
- ③ Eaton Cutler Hammer 8530 K2 single pole (Momentary-Off-Momentary) switch or equivalent.
- ④ RE mating connectors are Delphi Packard Weather Pack
Part Numbers
Connector Body: 12015792 (Qty 3)
Terminal: 12089188 (Qty 6)
Cable Seal: 12015323 (Qty 6)

Eaton Kit Part Number: 990756-000
(kit includes hardware for all three mating connectors)

RE (Remote Electric) Control Conversion Kits – There are two types of conversion kits available to convert Models 33-64 Eaton heavy duty Series (0) and (1) hydrostatic pumps to include a Remote Electric Control. One type contains both the RE Control and link kits with a manual displacement control and the second conversion kit contains only the RE Control.

Manual Displacement Controls:

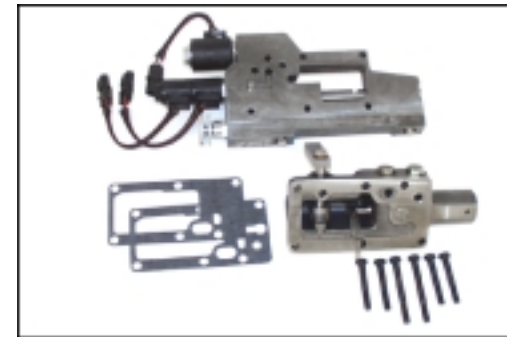

- Available (P) Orifice Sizes:
- 036
 - 044
 - 052
 - 057
 - 065
 - 073

990814-XXX* (replaces 990785-XXX)
with Manual Displacement Control configured with 3, 2-pin connectors (shown above)

QTY	Part Number	Description
1 ea	111883-013	RE Control S/A
2 ea	110213-000	Gasket
4 ea	95862-225	Cap Screw
2 ea	95862-300	Cap Screw
1 ea	110470-XXX	Manual Displacement Pump Control Valve with Control Supply Orifice

990834-XXX* (replaces 990755-XXX)
with Manual Displacement Control configured with 1, 2-pin Pause/Resume connector and 1, 4-pin stroking valve connector (not shown)

QTY	Part Number	Description
1 ea	111885-013	RE Control S/A
2 ea	110213-000	Gasket
4 ea	95862-225	Cap Screw
2 ea	95862-300	Cap Screw
1 ea	110470-XXX	Manual Displacement Pump Control Valve with Control Supply Orifice

*The XXX designates the (P) orifice diameter installed in the manual displacement control.

Kits with Control only:

Installation of this kit requires modifying the standard manual displacement control to incorporate a new Control Link S/A and a new Control Connector S/A.

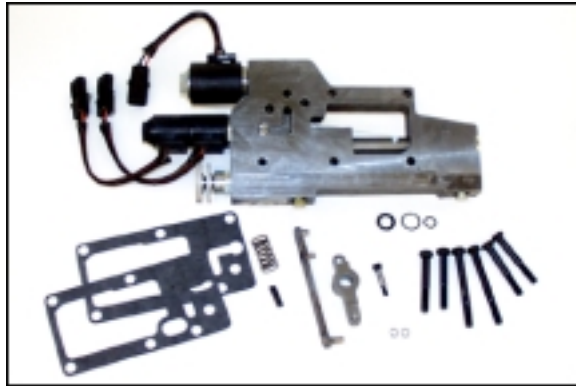

990820-000 (replaces 990755-XXX)
without Manual Displacement Control configured with 3, 2-pin connectors (shown above)

QTY	Part Number	Description
1 ea	111883-013	RE Control S/A
1 ea	102765-000	Control Link S/A
1 ea	110468-000	Control Connector S/A
2 ea	110213-000	Gasket
4 ea	95862-225	Cap Screw
2 ea	95862-300	Cap Screw
1 ea	96201-088	Slotted Pin
1 ea	104713-000	Dust Seal
1 ea	8761-012	O-Ring
2 ea	96098-025	Retaining Ring
1 ea	8761-016	O-Ring
1 ea	111820-000	Spool Spring
1 ea	96273-075	Shoulder Bolt

Replacement Solenoids/Coils (included in 111883-013 and 111885-013 RE Control S/A)

QTY	Part Number	Description
1 ea	109379-001	Solenoid Cartridge NC (Pause/Resume)
1 ea	201567-000	12V Coil with Diode with 2 pin connector
1 ea	202603-000	4-Way Solenoid Cartridge
1 ea	201546-000*	12V Coil with Diode with 2 pin connector
1 ea	111207-000**	12V Coil with Diode with 4 pin connector

* (if replacing complete assembly use two coils)
** (this is a subassembly and includes 2 coils)

Step 26

The heavy duty variable displacement pump with remote electric control is now ready for startup and test.

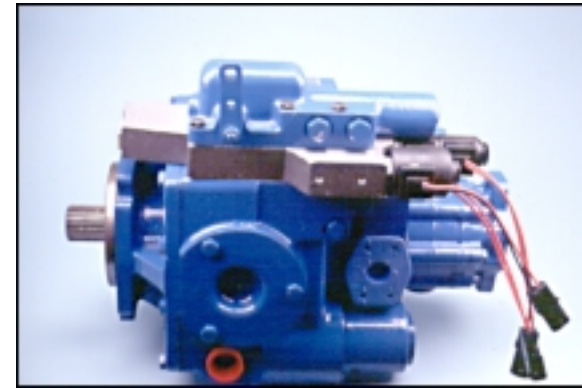

Typical Remote Electric (RE) Control Connection Diagram

This is an example of an application with two operator stations. Switches, power fuse, battery and wire harness are supplied by customer.

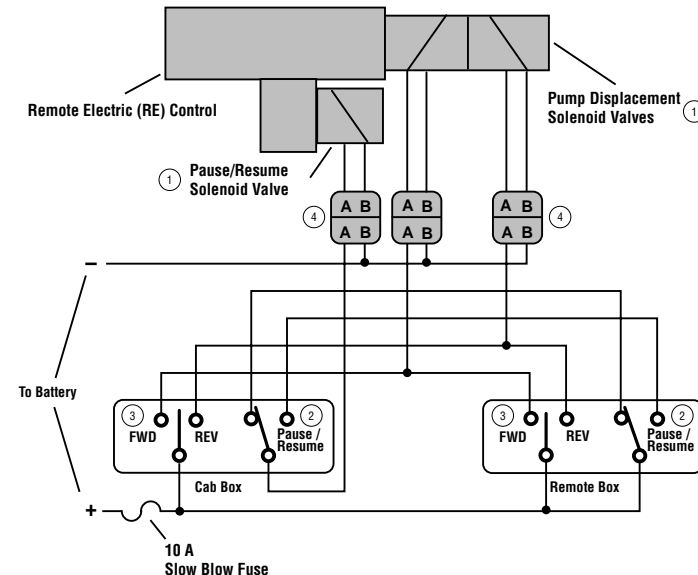

Step 24

Carefully set the manual control assembly on the remote electric control using caution not to disturb the previously installed control gasket.

IMPORTANT: The control and swashplate links must fold backwards toward the rear or charge pump end of the pump.

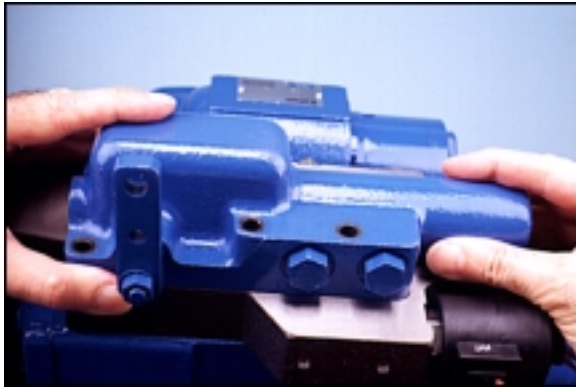

Step 25

Install the new retaining cap screws. Torque cap screws to 16 ft. lbs. [22 Nm].



990815-000 (replaces 990787-XXX)

without Manual Displacement Control configured with 1, 2-pin connector and 1, 4-pin connector (not shown)

QTY	Part Number	Description
1 ea	111885-013	RE Control S/A
1 ea	102765-000	Control Link S/A
1 ea	110468-000	Control Connector S/A
2 ea	110213-000	Gasket
4 ea	95862-225	Cap Screw
2 ea	95862-300	Cap Screw
1 ea	96201-088	Slotted Pin
1 ea	104713-000	Dust Seal
1 ea	8761-016	O-Ring
2 ea	96098-025	Retaining Ring
1 ea	8761-016	O-Ring
1 ea	111820-000	Spool Spring
1 ea	96273-075	Shoulder Bolt

990756-000 Mating Weather Pack connector kit

(for use with conversiton kit numbers 990814-XXX, 990820-000)

Kit contains (3) 2 pin Weather Pack connectors



990842-000 Mating Weather Pack connector kit

(for use with conversiton kit numbers 990824-XXX, 990815-000)

Kit contains (1) 2 pin Weather Pack connector

(1) 4 pin Weather Pack connector



Mating Connector Kits include connector bodies, terminals and cable seals.

990860-000

**Without Manual Displacement Control. Configured with 3, 2-pin connector.
Includes .141" orifice in pause/resume valve.**

<u>QTY</u>	<u>Part Number</u>	<u>Description</u>
1 ea	113675-001	RE Control S/A
1 ea	102765-000	Control Link S/A
1 ea	110468-000	Control Connector S/A
2 ea	110213-000	Gasket
4 ea	95862-225	Cap Screw
2 ea	95862-300	Cap Screw
1 ea	96201-088	Slotted Pin
1 ea	104713-000	Dust Seal
1 ea	8761-012	O-Ring
2 ea	96098-025	Retaining Ring
1 ea	8761-016	O-Ring
1 ea	111820-000	Spool Spring
1 ea	96273-075	Shoulder Bolt

Step 22

Install the second new control gasket by again aligning the fluid passage ports and retaining cap screw holes.

**Installation of the RE Control Conversion Kt on a Pump****Disassembly****Step 1**

Clean the pump thoroughly. If conversion will be performed without removing pump from machine, case fluid level will need to be lowered below control mounting surface.

**Step 23**

When assembling the manual displacement control, insert the pin on the control link into the swashplate link. Slide the pin on the connector into the slot machined in the remote electric control piston as shown here.



Step 20

Carefully install the new remote electric control by aligning the fluid passage ports and retaining cap screws hole.

CAUTION: Care must be used when installing the control. Do not dislodge the previously installed gasket or disturb the swashplate link from the upright position.

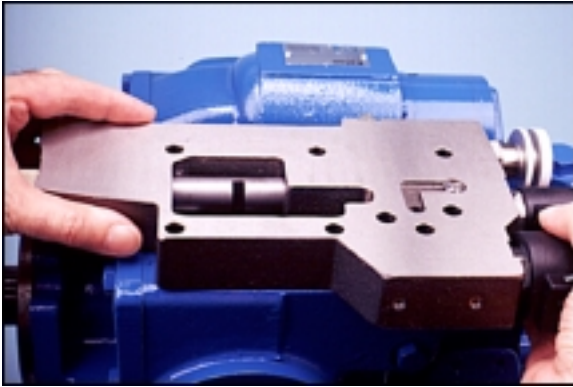
**Step 21**

Shown here is the orifice located in the remote electric control. In most cases it will not be necessary to remove this orifice, unless the orifice needs to be replaced. You can remove this orifice with a 1/4" socket or offset box end wrench. **Note:** Torque the orifice to 18 to 20 lbf-in.

**Step 2**

To remove the manual displacement control, use a 1/2 inch socket or open-end wrench and remove the control's retaining cap screws and discard.

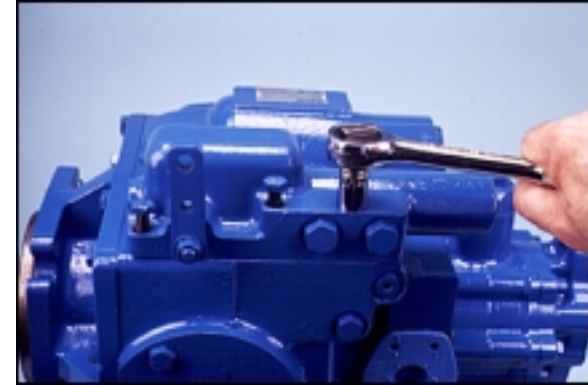
**Step 3**

Next, carefully lift the control valve assembly upward and slide away from the pump to disengage the control link from the swashplate link.



Step 4

Remove the control gasket from the pump housing and discard.

NOTE: If installing an RE Control kit which includes the manual displacement control (Kit Number 990834-XXX or 990814-XXX), skip to step 18 of the reassembly process.

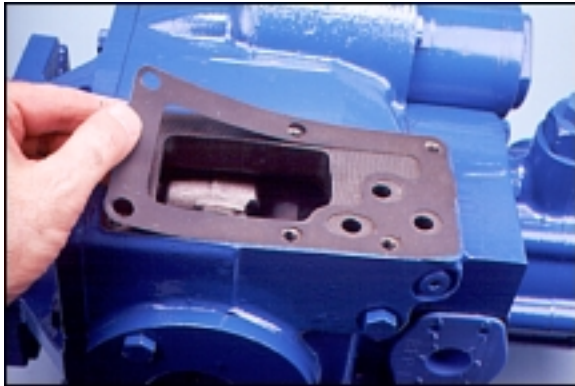
**Step 5**

Support the control assembly in a vise with the link facing upward. In most cases it will not be necessary to remove the orifice that is staked in the housing unless a different orifice size is desired. The orifice size is stamped on the orifice. (orifice must be .073 or less)

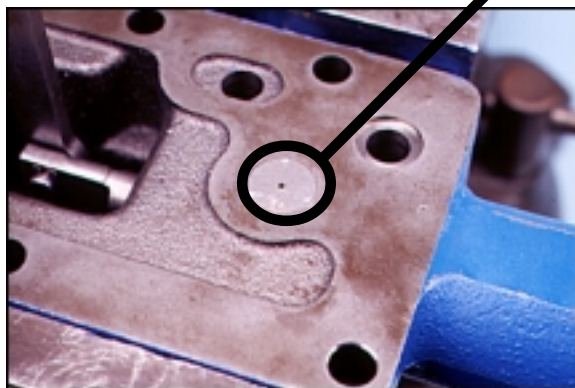
**Step 18**

Install a new gasket by aligning the fluid passage and retaining cap screw holes.

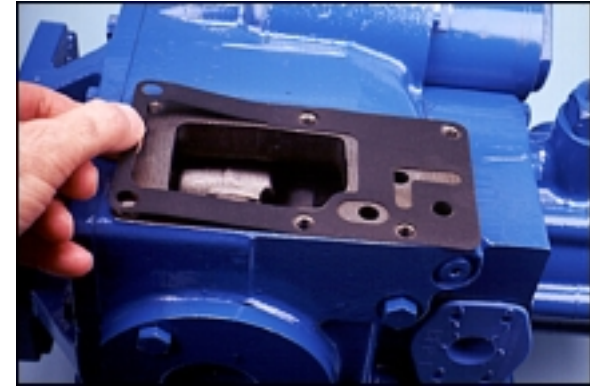
**Step 19**

Apply a small amount of petroleum jelly to the swashplate link where it is attached to the swashplate. This will be used to help it stand in the upright position. It will be a lot easier to install the control's link to the swashplate link if its is in the upright position.



Step 16

Lubricate and install the new dust seal over the shaft with the lip of the seal facing upward. Using a deep-wall socket or similar tool, carefully press or drive the seal in until it contacts the bottom of the counterbore in the control housing.

**Step 17**

Install the handle on the shaft. Position of the handle should be approximately parallel with the link. Install the lock washer and retaining nut. Torque nut to 16 to 19 ft. lb. [21,7 to 25,8 Nm].

**Step 6**

Remove the linkage from the spool. This is done by using a very small pair of 90 degree external retaining ring pliers to remove the retaining ring from the link.

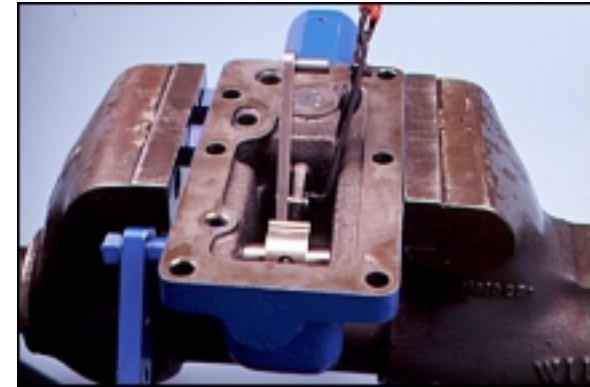
**Step 7**

Use a 3/16 inch hex or Allen wrench to back out the shaft set screw at least two full turns.

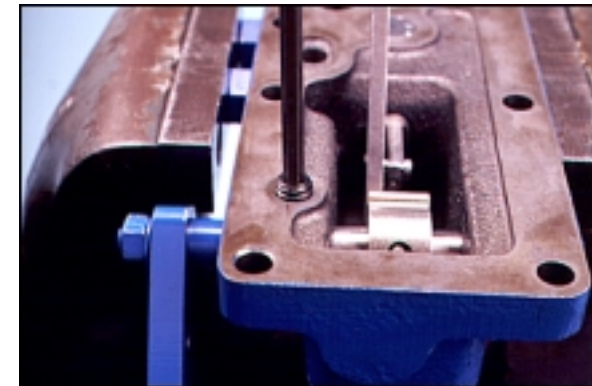

Step 8

With the shaft set screw backed out, slide the shaft assembly over to disengage the link from the control spool. Next, pull the link assembly upward past the spool and slide it over to disengage it from the connector.

NOTE: Use a small screwdriver or similar tool to push the control spool inward a little to allow the link assembly to pass by.

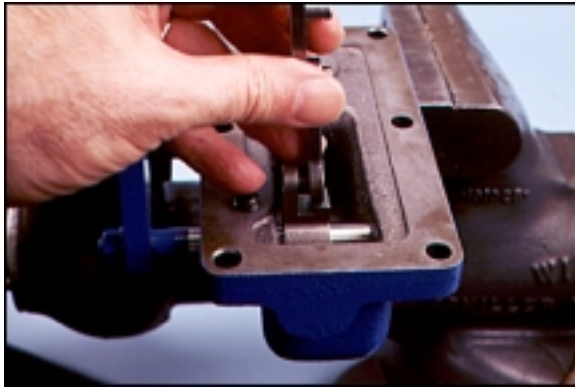
**Step 9**

With the link assembly removed, remove the retaining ring and separate the two links.

**Step 14**

Assemble the link to the shaft by aligning the link pin with the hole in the spool and slide the assembly over to engage. Install new retaining ring.

**Step 15**

Center the shaft and align set screw with groove in the shaft. Tighten set screw until it bottoms out, then back it out 1/4 turn.

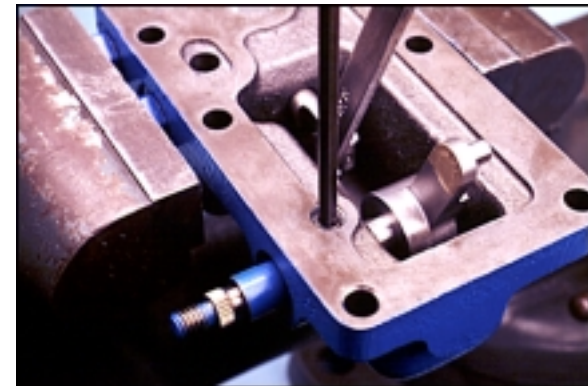

Step 12

Using a small screwdriver, push the control spool inward, just enough to allow the lower link to pass by.

**Step 10**

With the control assembly firmly supported in a vise, use 1/4 inch punch and drive the connector pin inward to separate the shaft assembly from the connector.

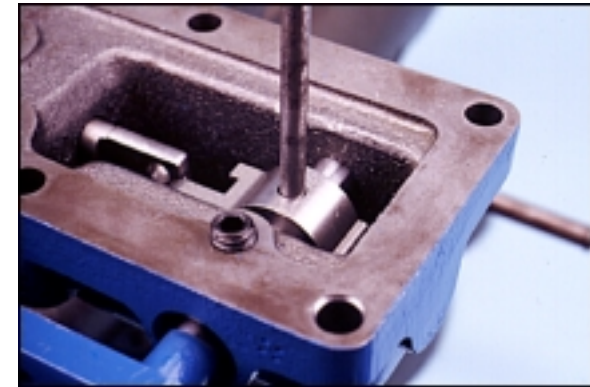
**Step 13**

Align the connector pin with the cross hole in the control shaft. After aligning, use a straight punch and drive the connector pin inward until the pin is centered in the connector.

**Step 11**

Remove the shaft and connector from the control housing assembly.

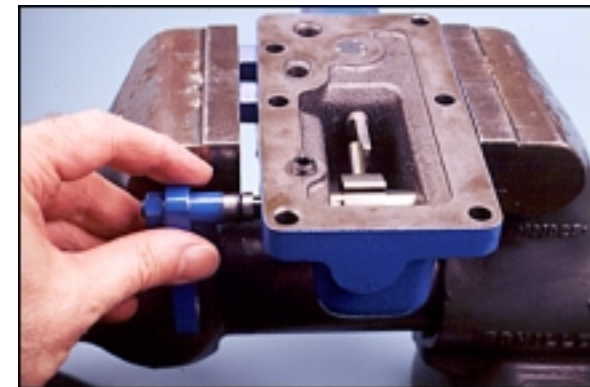

Step 12

Using a 1/2 inch socket or open end wrench remove handle retaining nut, lock washer and handle from the shaft.

**Step 13**

Next, using an O-ring pick or similar tool, remove the sealing ring from the shaft and discard.

**Step 10**

Lubricate the sealing ring and install in groove located in the shaft.

**Step 11**

With the previously started connector pin pointing toward the spool, install control shaft into housing and connector/link assembly.



Step 8

Assemble the small connector link to the new, longer link assembly. When assembling the two links, the pins must face the same direction. After assembly, install the new small retaining ring.

**Step 9**

Assemble the connector. Install by aligning the flat on the connector link with the flat on the connector. Push the connector link pin into the connector and rotate the link. This will interlock the link in the connector.

**Step 14**

With the shaft removed, use a small screwdriver and carefully remove the dust seal from the housing.

CAUTION: Do not scratch the housing's counterbore when removing the seal.

**Step 15**

Using a 3/32 hex head wrench remove the set screw that holds the spring box adjustment screw in place.

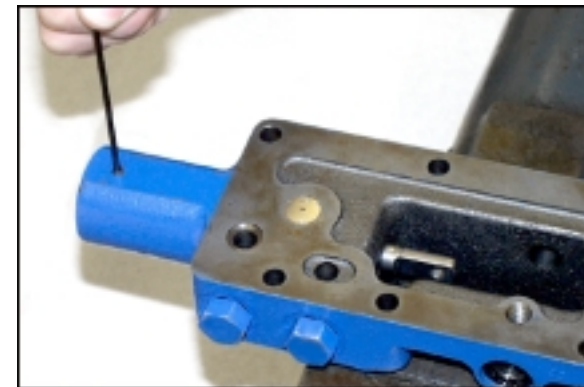

Step 16

Mark a location line on the spring box adjustment screw and the controller housing as shown below. This will aid in setting neutral during reassembly.

**Step 17**

Using a channel lock pliers or similar tool remove the spring box adjustment screw.

**Step 6**

Install set screw into the control housing using a 3/32 hex head wrench.

**Step 7**

Start the connector pin in the new connector. The pin in the connector must face you and point toward the right as shown here.

CAUTION: Do not drive the connector pin in too far, as the control shaft must slip through the connector.

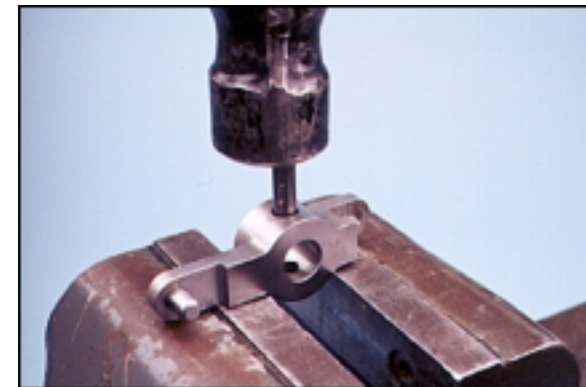

Step 4

Lubricate and install the new O-ring onto the spring box adjustment screw.

**Step 5**

Screw the spring box adjustment screw in until the witness mark and location marks line up with the set screw hole (a flashlight may be needed to help locate the witness mark).

Note: To make sure the spool is in the neutral position move the spool back and forth. You should only feel spring pressure when you move the spool back and forth. If there is play in the spool, turn the spring box adjustment screw in or out to remove the play. Do not compress the spool spring while moving spool back and forth.

**Step 18**

Using an O-ring pick or similar tool remove the O-ring from the spring box adjustment screw and discard.

**Step 19**

With the spring box adjustment screw removed, carefully push the control spool assembly out through the controller housing.



Step 20

Use a 1/8 hex head wrench to remove the shoulder screw, spring retainer, spring and spring box spacer. Discard spring and shoulder screw. We are now ready to reassemble the control with the new components.

**Reassembly****Step 1**

Reassemble control spool assembly using the new light force spool spring (P/N 111820-000) and the new shoulder screw (P/N 96273-075) Note: The old shoulder screw has a loctite® patch which cannot be re-used.

Note: Torque the shoulder screw to 33-40 in·lbs.

CAUTION: Shoulder screw must be seated against the spool. Be careful not to pinch spacer between shoulder screw and spool. Spacer must be able to slide up and down along the shoulder screw and compress the spring after assembly. (see photo)

**Step 2**

Using caution not to damage the spool assembly, insert into the housing.

**Step 3**

Make note of the witness mark on the side of the spring box adjustment screw.

NOTE: If there is more than one witness mark, refer to step 5 on page 20 and make sure the witness mark that corresponds to the location line is used.

