

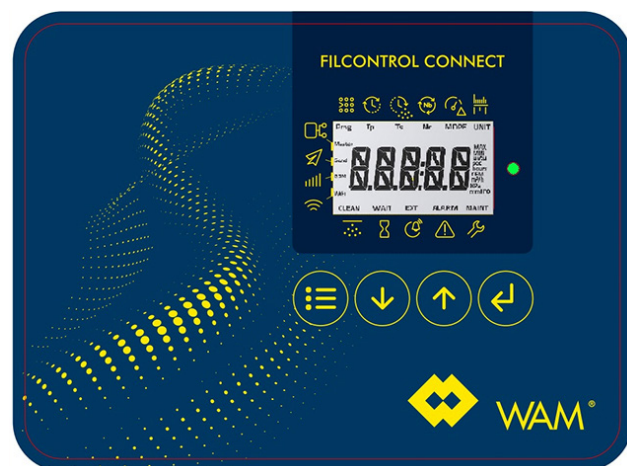

FILCONTROL TIME & FILCONTROL CONNECT

ELECTRONIC CONTROL BOARDS

ASSEMBLY INSTRUCTIONS



063002705	Revision: A2	Latest update: April 2021
ORIGINAL INSTRUCTIONS IN ENGLISH		

WAMGROUP S.p.A.
Via Cavour, 338
I-41030 Ponte Motta
Cavezzo (MO) - ITALY

☎ + 39 / 0535 / 618111
 ✉ + 39 / 0535 / 618226
 ✉ info@wamgroup.com
 internet www.wamgroup.com





All the products described in this catalogue are manufactured according to **WAMGROUP S.p.A. Quality System procedures**. The Company's Quality System, certified in July 1994 according to International Standards **UNI EN ISO 9002** and extended to the latest release of **UNI EN ISO 9001**, ensures that the entire production process, starting from the processing of the order to the technical service after delivery, is carried out in a controlled manner that guarantees the quality standard of the product.

**This publication cancels and replaces any previous edition and revision.
We reserve the right to implement modifications without notice.
This catalogue cannot be reproduced, even partially, without prior written consent by the Manufacturer.**



TABLE OF CONTENTS

1.0 SAFETY RECOMMENDATIONS 1

2.0 GENERAL FEATURES 4

2.1 Earthing connection 4

2.2 Marking 5

2.3 Limits of use applicable to both model of control boards 6

3.0 FILCONTROL TIME 11

3.1 Function 11

3.2 User interface 11

3.3 Connections 12

3.4 Wiring diagram 13

3.5 Standard programming 14

4.0 FILCONTROL CONNECT 15

4.1 Functions 15

4.2 User interface 15

4.3 Connections 18

4.4 Wiring diagram and external connections 19

4.5 How to switch on the electronic board 23

4.6 Main controls 23

4.7 INFO mode 23

4.8 Simplified programming 24

4.9 Advanced programming 31

4.10 Accessory modules (OPTION) 36

4.11 Errors Log/Info 46

A ATTACHMENTS 49

A1 Declaration of Incorporation 49



All personnel involved in installation, use and maintenance operations of the equipment and of its components has to receive the suitable technical training as regards the tasks to be carried out, particularly referred to potentially explosive atmospheres areas.
 Any modification on this equipment can void its safety requirements. Always follow the instructions provided by the manufacturer.



The apparatus is suitable for operation in ZONE 22

The zones are defined as follows.

ZONE 0: An area in which an explosive gas or air mixture of flammable substances atmosphere is present continuously or for long periods.

ZONE 1: An area in which an explosive gas or air mixture of flammable substances atmosphere is likely to occur in normal operation.

ZONE 2: An area in which an explosive gas or air mixture of flammable substances atmosphere is not likely to occur in normal operation and, if it occurs, will only exist for a short time.

ZONE 20: A place in which an explosive atmosphere in the form of a cloud of combustible dust in air is present continuously, or for long periods or frequently.

ZONE 21: A place in which an explosive atmosphere in the form of a cloud of combustible dust in air is likely to occur in normal operation occasionally.

ZONE 22: A place in which an explosive atmosphere in the form of a cloud of combustible dust in air is not likely to occur in normal operation but, if it does occur, will persist for a short period only. It is forbidden to use the apparatus in areas classified as zone 20, 21, zone 0, 1 or 2.



The apparatus is suitable to operate with granular materials (ST1, ST2 class powders) containing possibly small quantities of combustible dusts, non-conductive, with the following characteristics:

Minimum ignition temperature (MIT)	°C	> 210
Minimum ignition temperature of a 5 mm layer of dust (LIT)	°C	>210
Min ignition energy (MIE) All operating temperatures	mJ	≥ 3

It is forbidden to use the apparatus with hybrid mixtures, explosives, chemically unstable powders.



The user must make sure the equipment is used according to the intended use, particularly in the ZONES that match those for which the equipment has been declared fit by the manufacturer. The permitted ambient temperature is: $-20^{\circ}\text{C} \leq T_{\text{amb}} \leq 60^{\circ}\text{C}$.



Any electrical or mechanical components to be installed on the apparatus must have certified category suitable for use:

- category 3D (Zone 22)

During maintenance or cleaning operations the user must ensure the equipment used (fans, portable lamps etc.) belong to the category suitable to the environment:

- category 3D (Zone 22)



The user shall make sure that the plant in which the apparatus is to be installed was properly set in safety conditions from an explosion risk point of view before starting it up and that the "Explosion protection document" has been written according to the Directive ATEX 1999/92/CE. 81-2008).



The installer has to make sure the process specifications match the features of the apparatus given on the plate (regarding, for instance, the maximum surface temperature).

If the features of the material are not compatible, it is forbidden to use the apparatus.



The user must never open the housing.

The installation, mounting and disassembling operations must be carried out with equipment switched off or in the absence of potentially explosive atmosphere.



It is forbidden to drill holes in the housing.

It is forbidden to modify the wiring diagram.

If no cable gland is used, it is compulsory to cover the hole with a certified stopper.



The equipment has been tested and certified by WAM to be used in ATEX environments and it is supplied with air piping and cable glands which have not been separately certified (i.e. they do not bear individually the ATEX marking, but they have been certified with the case that contains them).

IT IS FORBIDDEN TO MODIFY THE CABLES, CABLE GLANDS, PIPING AND CONNECTIONS.



INSTALLATION - START UP

Prior to the installation and start-up check to make sure the supply has not suffered damages during shipping.

The tools used for the installation must be compliant to EN 1127-1 depending on the zone of use.

The electrical connections must be performed by qualified personnel and in accordance with the indications given on the wiring diagram.

The equipment must not be installed in a position which may subject it to electrostatic charges, as for instance in case of a pneumatic transfer of powders or in electrostatic spraying of powders coating processes.



To avoid the formation of layers of combustible dust the user must clean the device.

It is recommended to avoid using compressed air for cleaning the layers of dust; use, instead, a suction systems suitable for potentially explosive powders (ATEX certified vacuum cleaner).



LIGHTNING: protection against atmospheric discharges.

The plant in which the equipment is being used must be protected against atmospheric discharges.



In the classified ZONES and near them there must not be any ignition sources such as:

- flames;
- coals;
- hot surfaces;
- sparks (e.g. caused by cutting of metals);
- stray currents and cathodic protection systems;
- electrical or mechanical features which are not ATEX certified;
- electrostatic charges borne by the operators or mobile equipment;
- radio frequency (RF) and electromagnetic waves (from 104Hz to 3* 1011Hz);
- electromagnetic waves (from 3x1011Hz to 3x1015Hz);
- ionizing radiations;
- ultrasounds;
- adiabatic compression and shock waves;
- exothermic reactions (including phenomena of self-priming of the powders).

2.0 GENERAL FEATURES

2.1 Earthing connection

If the board is purchased along with the machine, the connection to the bounding of the solenoid valve coils is performed by the manufacturer in the junction box shown below:

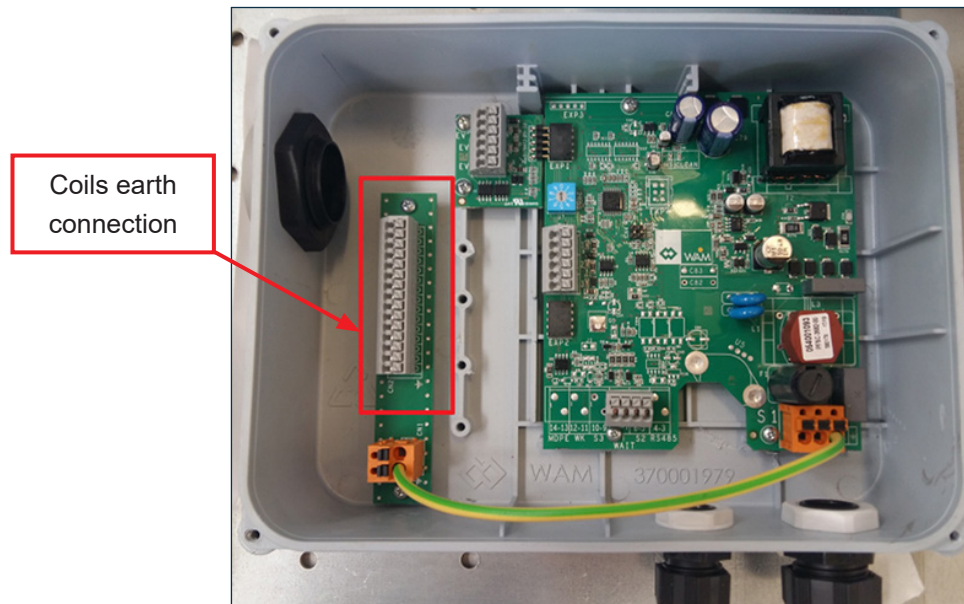

If the board is purchased as spare, these connections are in charge of the installer and must be performed by qualified personnel.

The earthing connection of the entire board is positioned inside the junction box as indicated below:

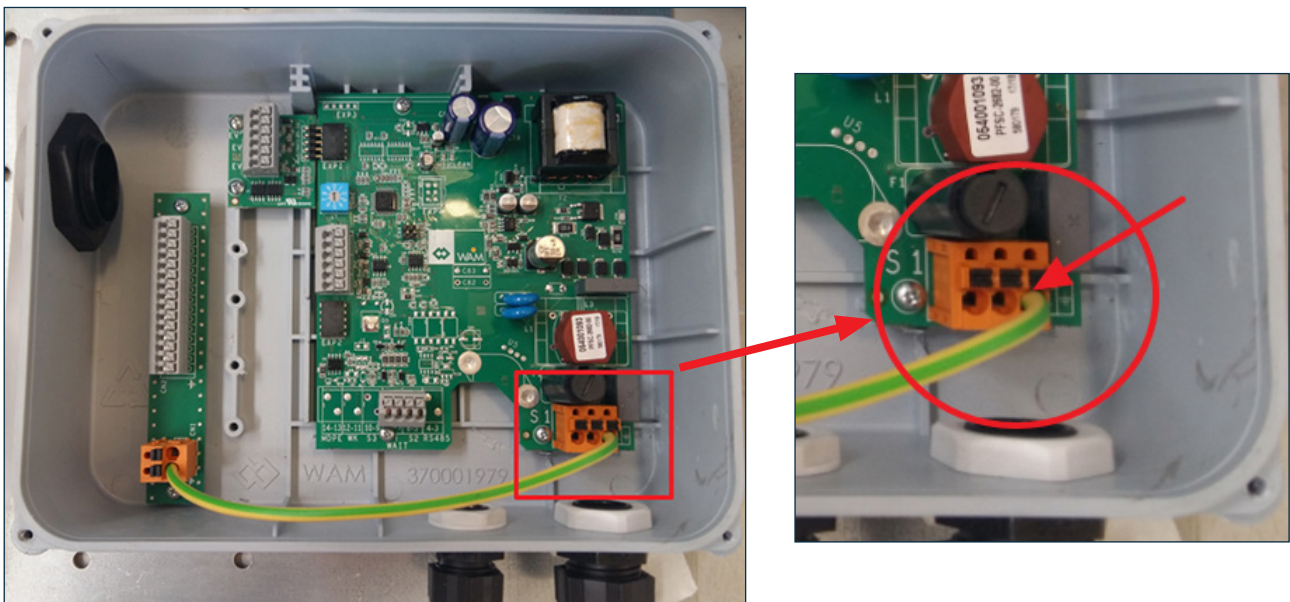
**Important**

IT is mandatory to always follow the instructions provided for the connection of the electronic board to the earthing, regardless the value of the supply voltage.

2.0 GENERAL FEATURES

The card is supplied with cable gland certified for the connection to the mains and for any other connections (signals or clean contact):

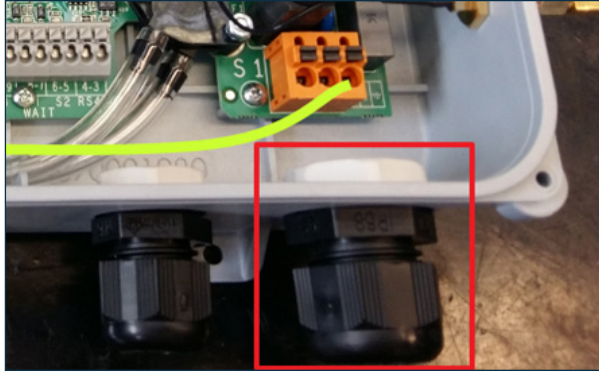
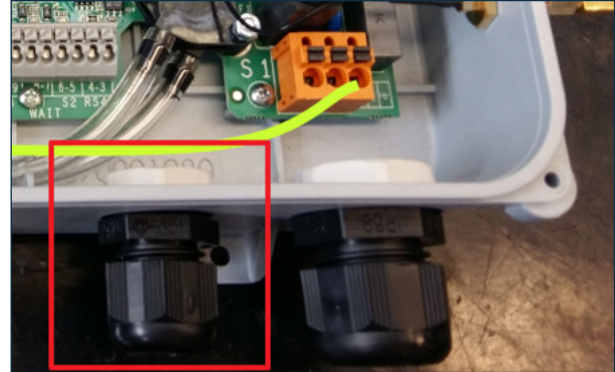
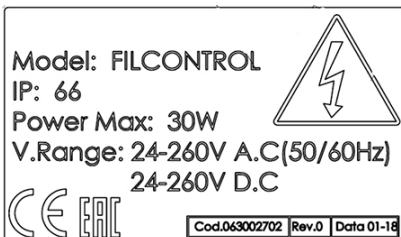
MAIN POWER SUPPLY

CLEAN CONTACTS

2.2 Marking
FILCONTROL NON ATEX

FILCONTROL ATEX

CE: CE marking related to the ATEX Directive 2014/34/EU (Dir. 94/9/EC before 19/04/2016)

Ex: Hexagon EX: compliant to the ATEX Directive 2014/34/EU (Dir. 94/9/EC before 19/04/2016)

II: Devices Group (I: electrical equipment for mines, II: electrical appliances for surface installations)

3D: Category 3D, i.e. apparatus suitable for use in ZONE 22

IIIC: Powders group (conductive dust)

T100: Maximum surface temperature

Dc: EPL Dc, i.e. apparatus suitable for use in ZONE 22

Tamb: ambient temperature

2.0 GENERAL FEATURES

Danger - Warning

The equipment is not provided with an electrical system. Connection to the mains has to be carried out by an electrician.

Provide mains supply to the equipment concerned according to the compliant current legislation and take into consideration the safety measures required by the installation environment and the envisaged operating conditions.

Before carrying out the connection ensure that the mains voltage and frequency correspond to those indicated on the electric motor rating plate.

Disconnect from the mains before carrying out any work and use suitable devices so that there cannot be an accidental reconnection.

2.3 Limits of use applicable to both model of control boards

Use electric cables having cross section appropriate to the power absorption of the motor of the equipment concerned.

The installer will have to provide to interfacing the equipment with the necessary controls: start/stop, emergency stop, reset after an emergency stop, in compliance with the regulatory standards in force.

Disconnect from the mains before carrying out any work and use suitable devices so that there cannot be an accidental reconnection.

At each start up ensure the safety devices installed are present and working.

The installer must connect the equipment to the earthing system of the plant.

In case of dust collectors manufactured by **WAM®**, the electronic board is located inside a box with IP66 protection in accordance with the Standard CEI EN 60529.

The board is supplied pre-wired; depending on whether it comes with the dust collector or as spare part, it can have the following features:

Supply type	Preloaded program	
Electronic board supplied with the filter	Depends on the filter	
	TIME: 3.5 Standard programming Page 14	CONNECT: Par. 4.8.4 Pre-set programs pag. 29
Board supplied as spare	Program 0	
	TIME: 3.5 Standard programming Page 14	CONNECT: Par. 4.8.4 Pre-set programs pag. 29

Table 1 - Features of the electronic board depending on the type of supply

The installer has the possibility to customise the program pre-installed by the manufacturer according to specific requirements.

2.0 GENERAL FEATURES

Important

The program must be changed when the board is supplied as a spare part.

All programs provided include *cleaning at the end of cycle*, which envisages the cleaning of the filtering elements with no reversed air flow, thus optimizing cleaning effectiveness.

The cleaning cycle is predefined on the basis of the program set and gets activated when the contact S2 opens.

The operating features of the electronic boards are the following:

Operating temperature	- 20°C to 80°C (normal operation); 100°C (peak temperature)
Input power supply	24 ± 15% V (AC-DC) => 260 ± 15% V (AC-DC)
Input supply frequency	0 Hz (DC) => 60Hz
Output voltage and frequency	24±10% (DC) controlled by for coils operation at 24V AC or DC

Table 2 - Operating features

2.3.1 Electronic board wiring

- 1) **SUPPLY VOLTAGE** - The electronic board operates with all voltage values from 24V to 260V, both in DC and AC.
- 2) **AUTOMATIC SUPPLY VOLTAGE IDENTIFICATION**- The electronic board identifies the supply voltage automatically, therefore no setting is required for normal operation.
- 3) **CONNECTIONS TO TERMINAL BOARD** - The electronic board is powered by means of terminal (S1) and accepts all the voltages mentioned at point 1) above.

Connect a clean contact (no voltage) to the S2 terminal to enable the cleaning cycle.

2.0 GENERAL FEATURES

TERMINAL	TERMINAL NO. ON THE BOARD	FUNCTION
S1	1 2	It's the power supply contact of the electronic board and works with all voltage values previously referred to at point 1 of section 2.3.1.
RS485	3 4	AVAILABLE ONLY ON FILCONTROL CONNECT Interface for Modbus communication with an external PC. Select the node that represents the address of the electronic board.
S2	5 6	It's a normally open contact, not powered, which must be closed to start the cleaning cycle. When it opens, it starts the cleaning at the end of the cycle that continues for a period of time which must be predefined in the program set. NB: the cleaning at the end of cycle starts only after having completed the cleaning cycle on all solenoid valves.
WAIT	7 8	It's a normally open contact, not powered, which must be closed to temporary stop the cleaning cycle. Use this control to save the solenoid valve which has been last active. When the contact is opened back, if S2 is closed, cleaning resumes from the next solenoid valve. If S2 is open, the cleaning cycle reaches the last solenoid valve present then goes in standby. The WAIT contact can be used as safety switch / alarm to stop temporarily and instantaneously the cleaning cycle.
S3	9 10	AVAILABLE ONLY ON FILCONTROL CONNECT It's programmable external signal that can be excluded, selected as normally open or normally closed. When activated, it generates an external signal.

Table 3 - List of main contacts

Important

IN CASE OF EMERGENCY, to completely stop the cleaning cycle, disconnect the electronic board from the power supply.

All technical information related to the FILCONTROL electronic board are printed on the rear side of the diagram applied on the cover of the box.

2.3.2 Connecting the expansion modules for the solenoid valves

The number of coils can vary from 3 to 15; if their positioning is of the absolute type, the expansion modules must be connected as shown below.

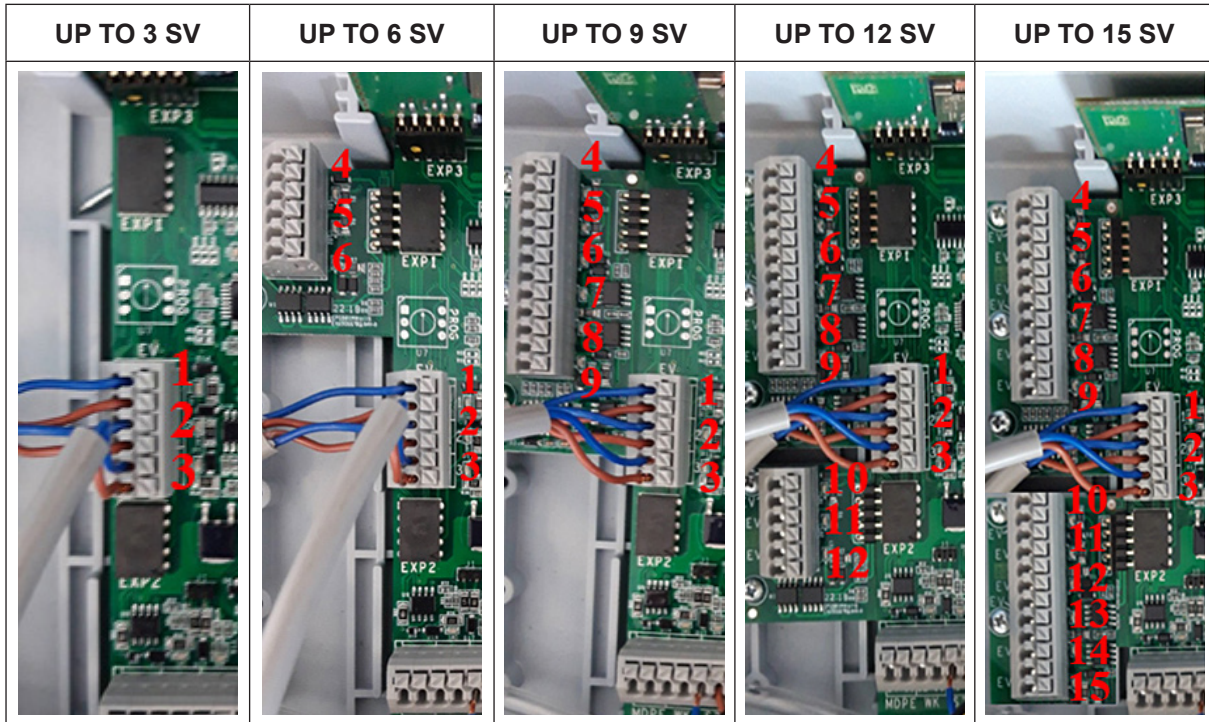

2.0 GENERAL FEATURES

2.3.3 Electronic board absorption

The following table contains the values referred to the power absorption of the control board on the basis of the power supply type.

SUPPLY VOLTAGE (VAC)	CURRENT (A)	POWER (W)
24	0,220	5.3
115	0,090	10.4
230	0,050	11.5
260	0,045	11.7

Table 4 - Electronic board absorption values depending on the supply voltage

**Important**

The table above refers to some examples of absorption depending on the supply voltage; the electronic board will however work correctly with all values of voltage from $24 \pm 15\% \text{ V (AC-DC)}$ => $260 \pm 15\% \text{ V (AC-DC)}$.

**Important**

The S1 supply has to be always provided on the panel (disable only for maintenance).

3.1 Function

The electronic boards have been designed for the timing of the filter cleaning, according 9 default programs (plus 1 self-test program).

The programs define the pause and blowing, both during normal cleaning and for the cleaning the end of the cycle. This electronic board model **DOES NOT** provide for the management of a MDPE sensor (pressure drop measuring between the dirty and the clean side of the filter).

3.2 User interface

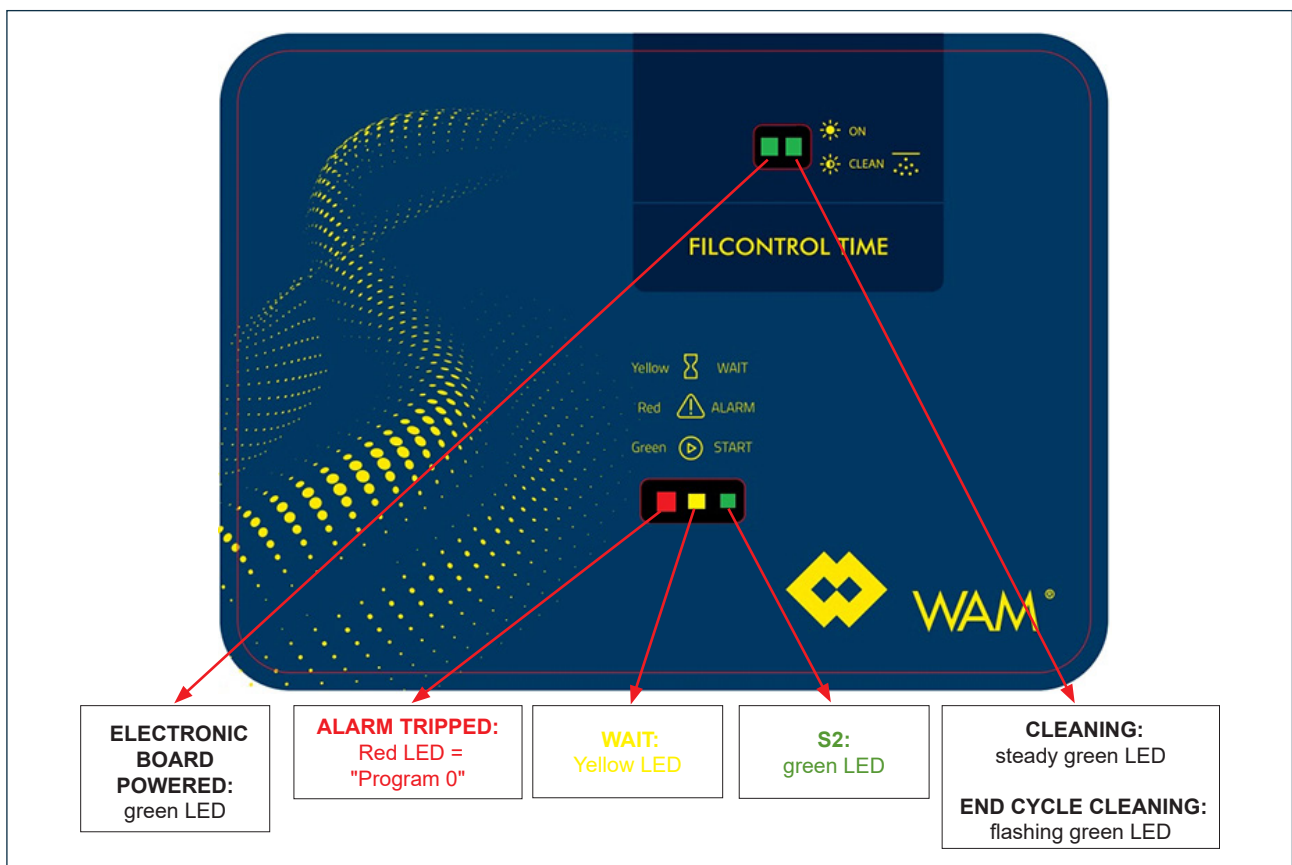

3.3 Connections

The connections available and their description is given below.

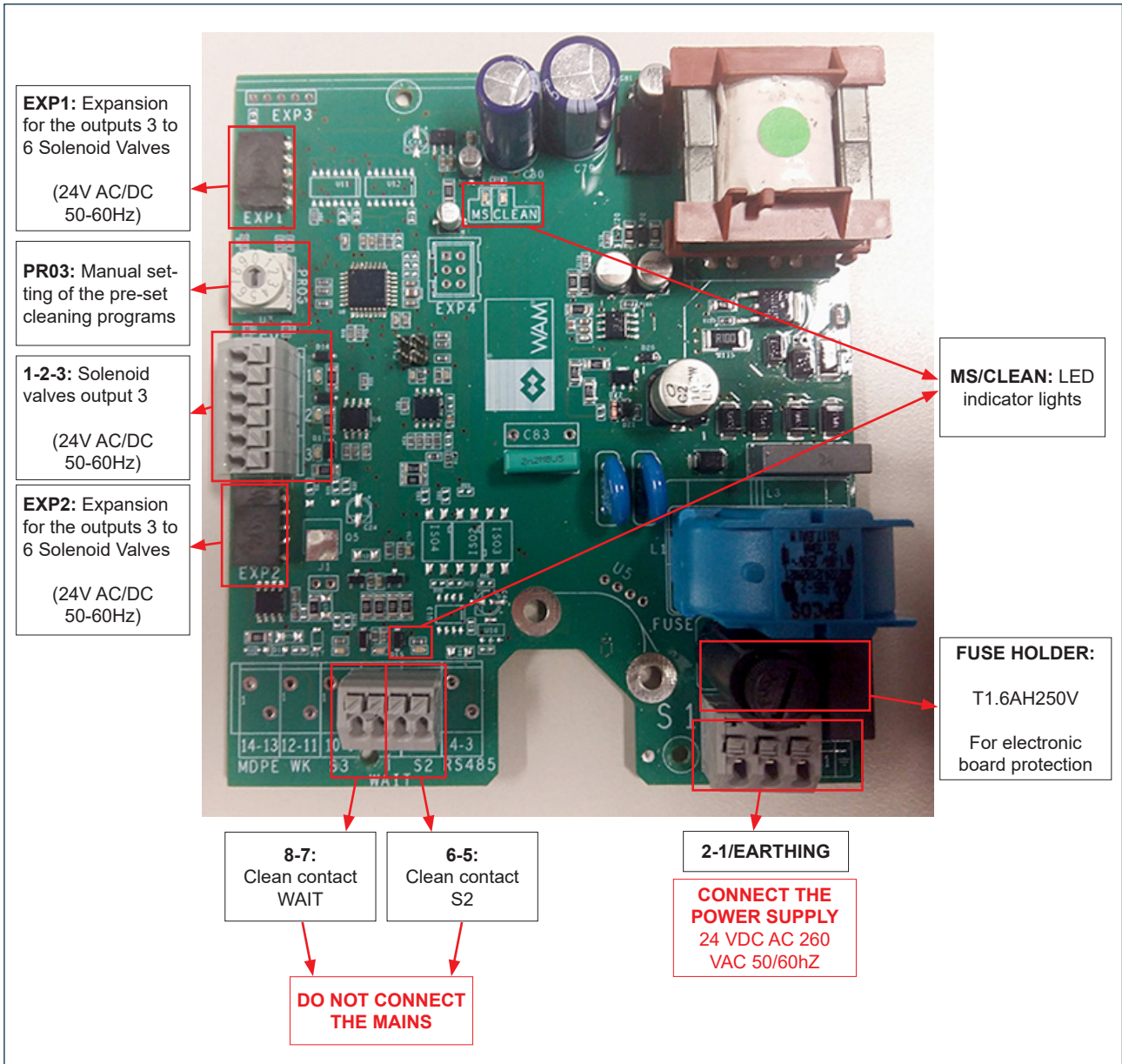

3.4 Wiring diagram

The wiring diagram of the board is given below:

FILCONTROL TIME

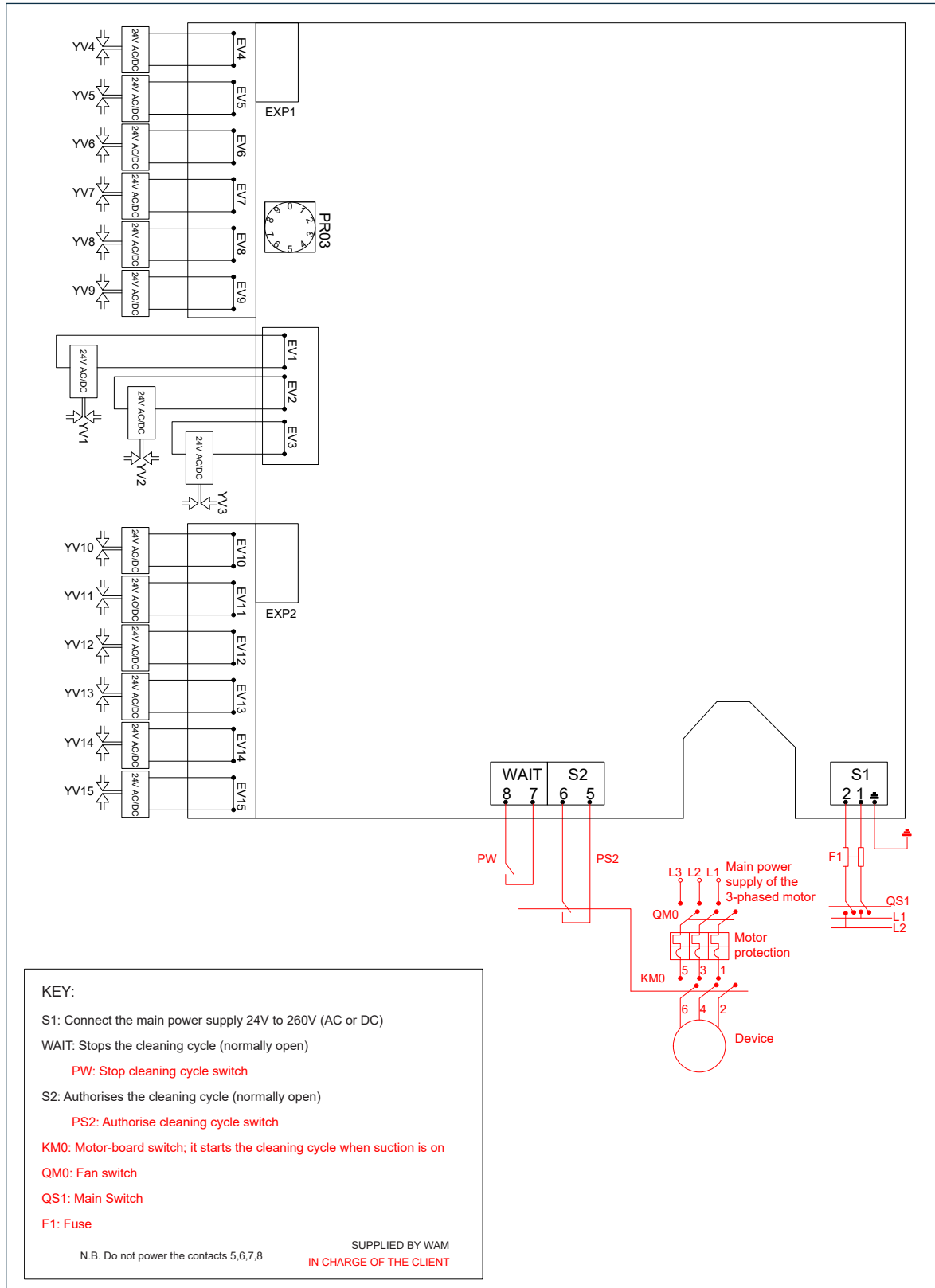

3.0 FILCONTROL TIME
3.5 Standard programming

The programs can be customised by using the rotary switch called **PR03** (check the **Section 3.3 Connections (page 12)**). The board goes into alarm status if operated on the 0 program.

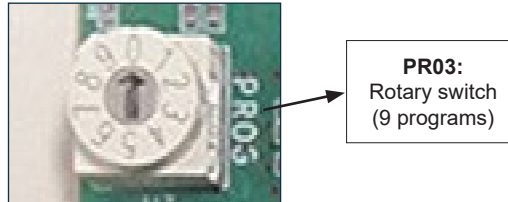

Prog. (D)	Description	Number [S/V]	Pause time [sec] PAUSE	Blow Time [ms] VALVE	Number of cleaning cycles at the end of cycle*
0	SELF-TEST-TEST	-	3	100	1
1	SILAB14	-	56	100	7
2	SILAB24	-	39	100	7
3	PLEATED_28	-	28	100	7
4	PLEATED_5	-	5	100	7
5	PLEATED_15	-	15	100	7
6	BAG/POCKET_5	-	5	210	7
7	BAG/POCKET_15	-	15	210	7
8	BAG/POCKET_28	-	28	210	7
9	BAG/POCKET_56	-	56	210	7

*Each cleaning cycle at the end of cycle includes one blow for each solenoid valve installed.

When the board is provided by the manufacturer installed on a dust collector, the programs are pre-set as follows:

FILTER ELEMENTS	PRE-SET PROGRAM
SILAB14	1
SILAB24	2
Filter with cartridges or pleated elements	3
Filter with bags or pockets	8
Filter with bags or pockets for applications in negative pressure	9

Important

If the board is supplied as spare part, by default it is set to the 0 program; the installer must change the program depending on the type of filter using the previous table.

4.1 Function

The function of the FILCONTROL CONNECT electronic board is similar to the function of the FILCONTROL TIME version, i.e. it manages the timing of the cleaning cycles of the dust collector. Furthermore, it allows to use additional devices to more effectively manage (by using a display) and control some of the parameters, be it locally or remotely.

The additional features of the version are listed below:

- User interface with touch-screen display;
- Measures and displays the value of ΔP through the MDPE sensor;
- 4/20mA output but for proportional transmission of the MDPE signal;
- Δp in "ACTIVE" configuration for "smart cleaning";
- Communication with the PLC via Modbus connection RS485;
- Management of external alarms with the contact S3;
- Remote WIFI or GPRS communication modules (option).

4.2 User interface



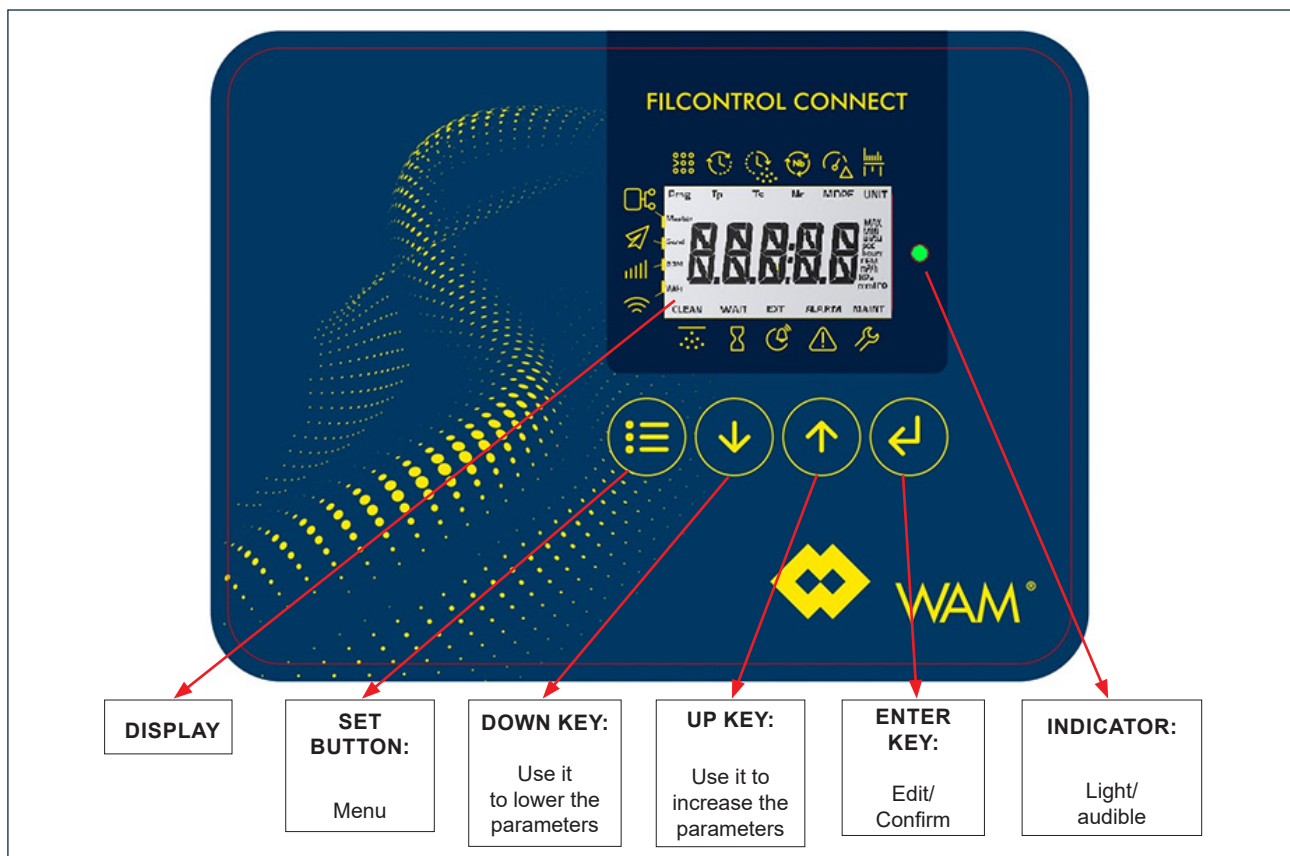

The touch keyboard kit (SET, DOWN, Up, ENTER keys) + LCD display integrated into the cover of the box is connected through a flat cable to the connector **EXP4 (Section 4.3 - page 18)** provided on the FILCONTROL CONNECT board.

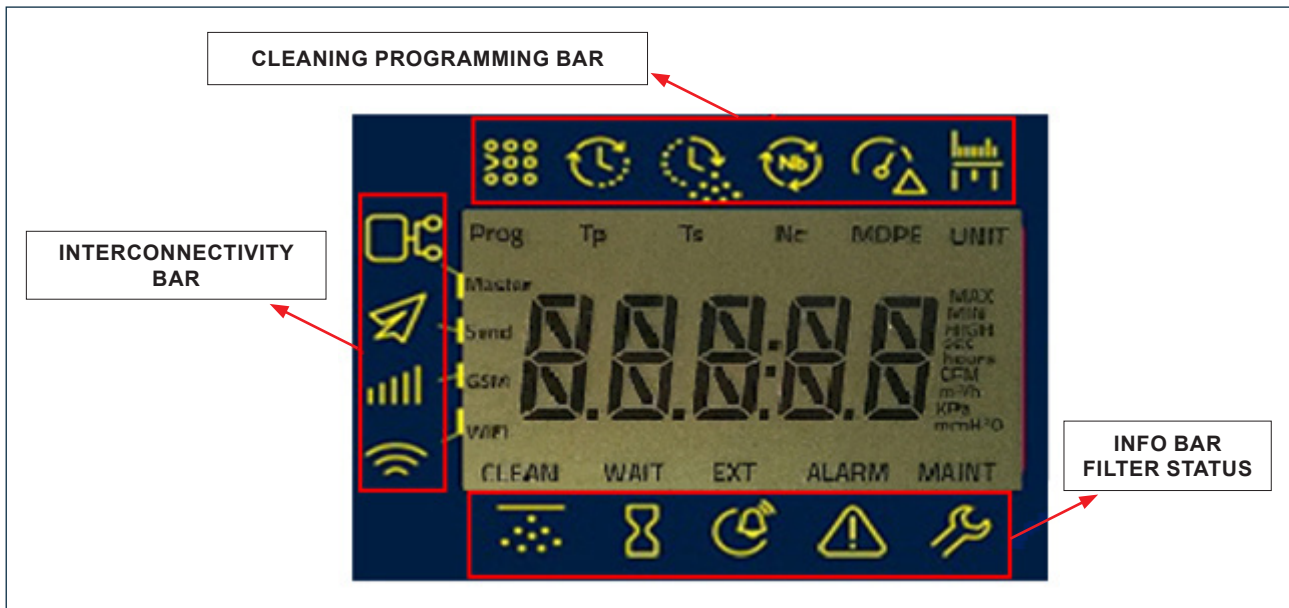



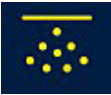



The parameters shown on the display are listed below:







The meaning of the symbols used is the following:

FILTER STATUS INFORMATION BAR			
KEYPAD ICON	REFERENCE on the DISPLAY	DESCRIPTION	EVENT
	CLEAN	The filter is running the cleaning cycle. When the filter is performing the cleaning at the end of the cycle, the caption "CLEAN" flashes.	During cleaning and in stand-by phase
	WAIT	Filter in standby, WAIT contact closed: the cleaning cycle is temporary stopped	
	EXT	External error, contact S3 active: an alarm has tripped on the board and the cleaning cycle is blocked	
	ALARM	At least one alarm has tripped	
	MAINT	Enable the maintenance mode, which allows programming the board	

4.0 FILCONTROL CONNECT

CLEANING PROGRAMMING BAR			
KEYPAD ICON	REFERENCE ON THE DISPLAY	DESCRIPTION	EVENT
	Prog	Program set - the display shows the letter "P" followed by the corresponding number	Info Mode Page 23 Programming Mode Page 31 (During cleaning and in standby phase)
	Tp	Pause Time - the display shows the time, in seconds, between one blow and the next	
	Ts	Blow Time - the display shows the opening time, in seconds, of the solenoid valve	
	Nc	Number of cleaning cycles performed with the S2 disabled	
	MDPE	ΔP Value	
	UNIT	Active in programming, changes the units of measure from the metric system (mmH ₂ or m ³ /h) and American system (KPa - CFM)	

INTERCONNECTIVITY BAR			
KEYPAD ICON	REFERENCE ON THE DISPLAY	DESCRIPTION	EVENT
	Master	Active when the network RS485 is connected	During cleaning and in stand-by phase
	Send	Active when a message is sent	
	GSM	Active when the module GPRS is active	
	WiFi	Active when the WiFi module is active	

4.3. Connections

The connections available and their description is given below.

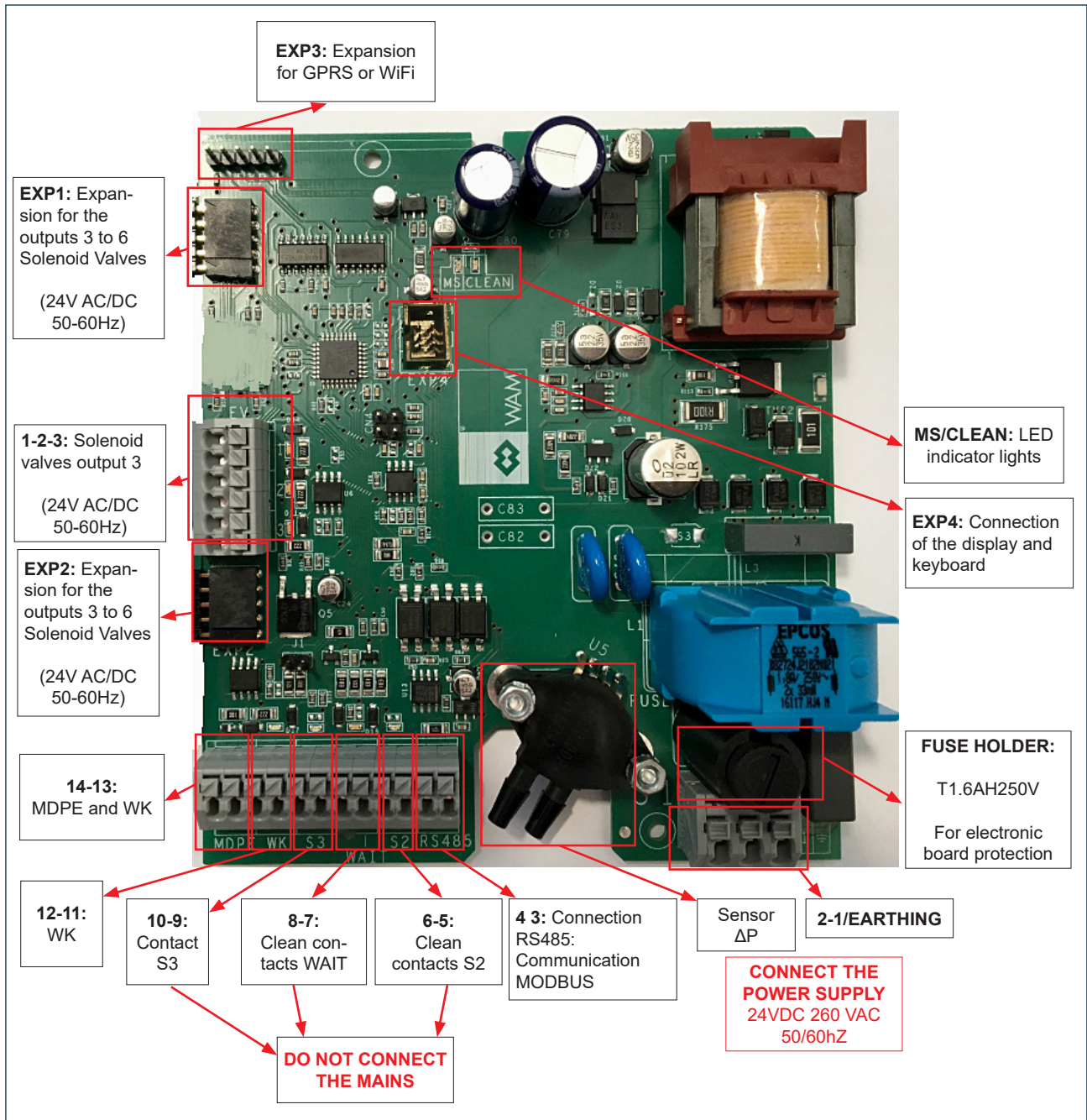

On the FILCONTROL CONNECT board, the contact S3 has the purpose to enable an external signal, while the contact RS485 (4 3) is used to enable the communication towards an external device (e.g. PC).

It also features the MDPE for the reading of the pressure difference between the clean and unclean part and the programmable outputs associated with it: alarm WK (11 12) and analogue signal [4-20 mA] (13-14) for proportional transmission of the value of ΔP .

4.4 Wiring diagram and external connections

The wiring diagram of the board is given below:

FILCONTROL CONNECT

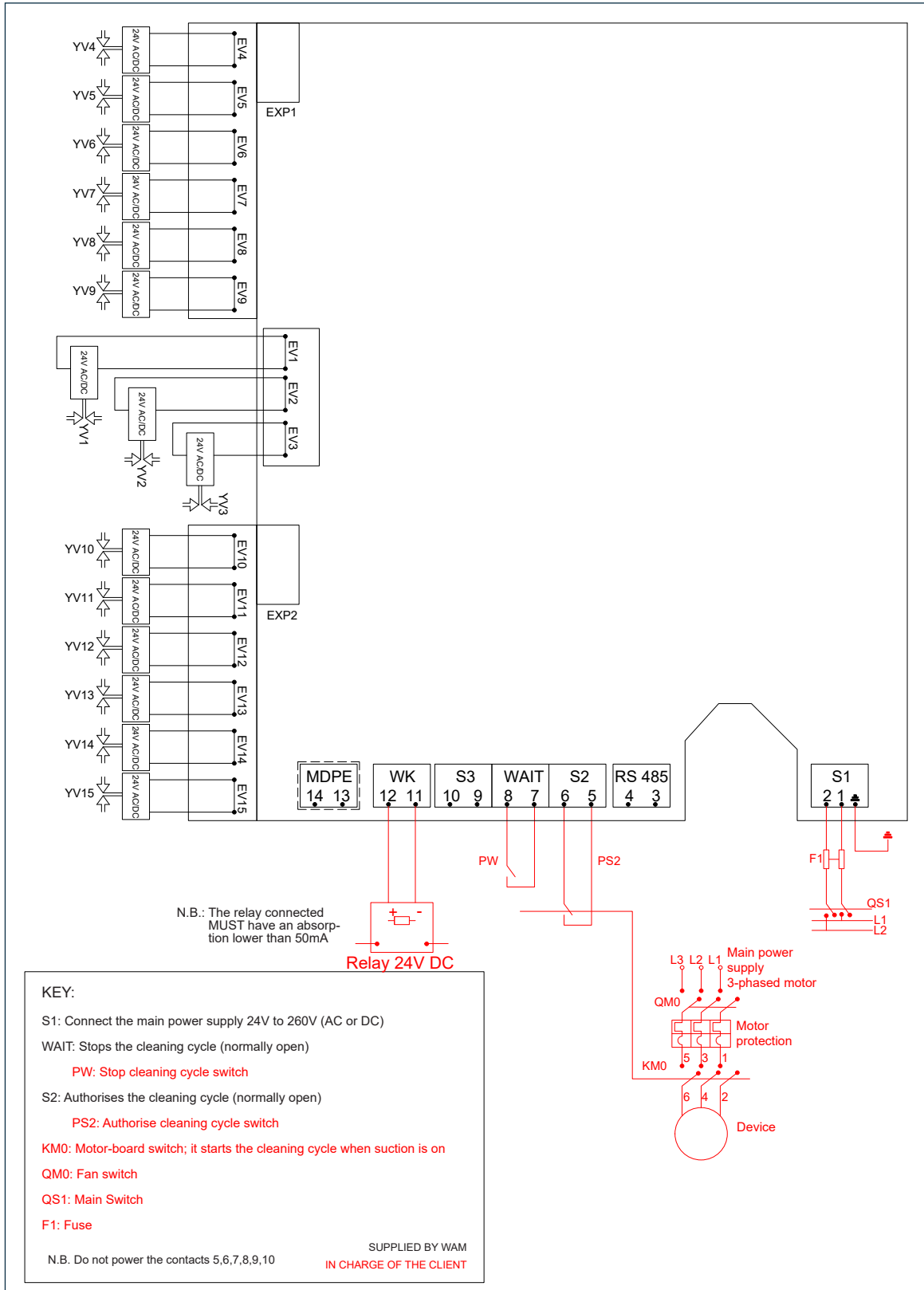

4.4.1 Wiring diagram for the connection of the MDPE and WK output

The wiring of the programmable outputs is shown below:

1. **PASSIVE signal:** voltage supplied by the external device

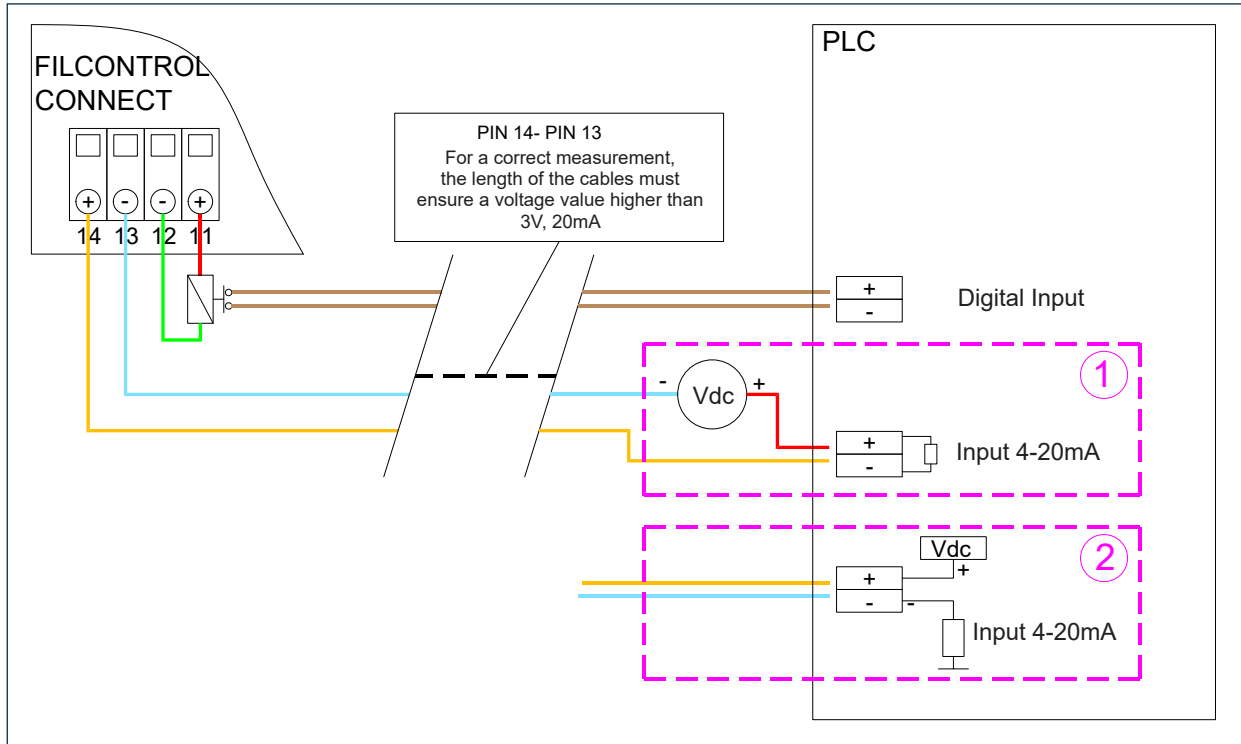

As regards the output 14-13, there are two cases:

- 1) Power is supplied by an external device
- 2) Power is supplied from the PLC

2. **ACTIVE signal:** voltage fed by FILCONTROL CONNECT

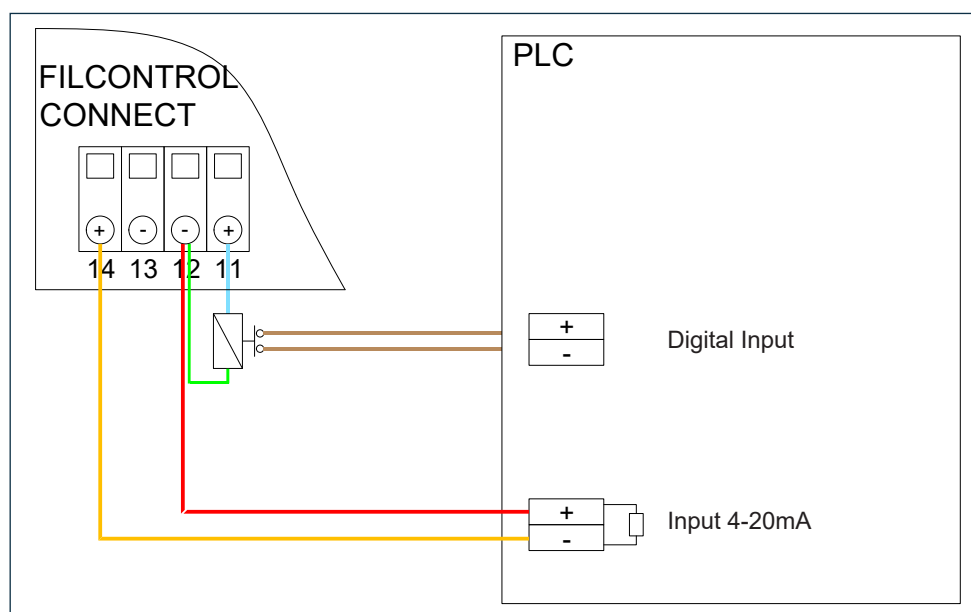



4.4.2 MDPE output control with 4-20mA

The function of this 4-20mA output is to provide a value proportional to the pressure read by the MDPE sensor; the correlation scale is the following:

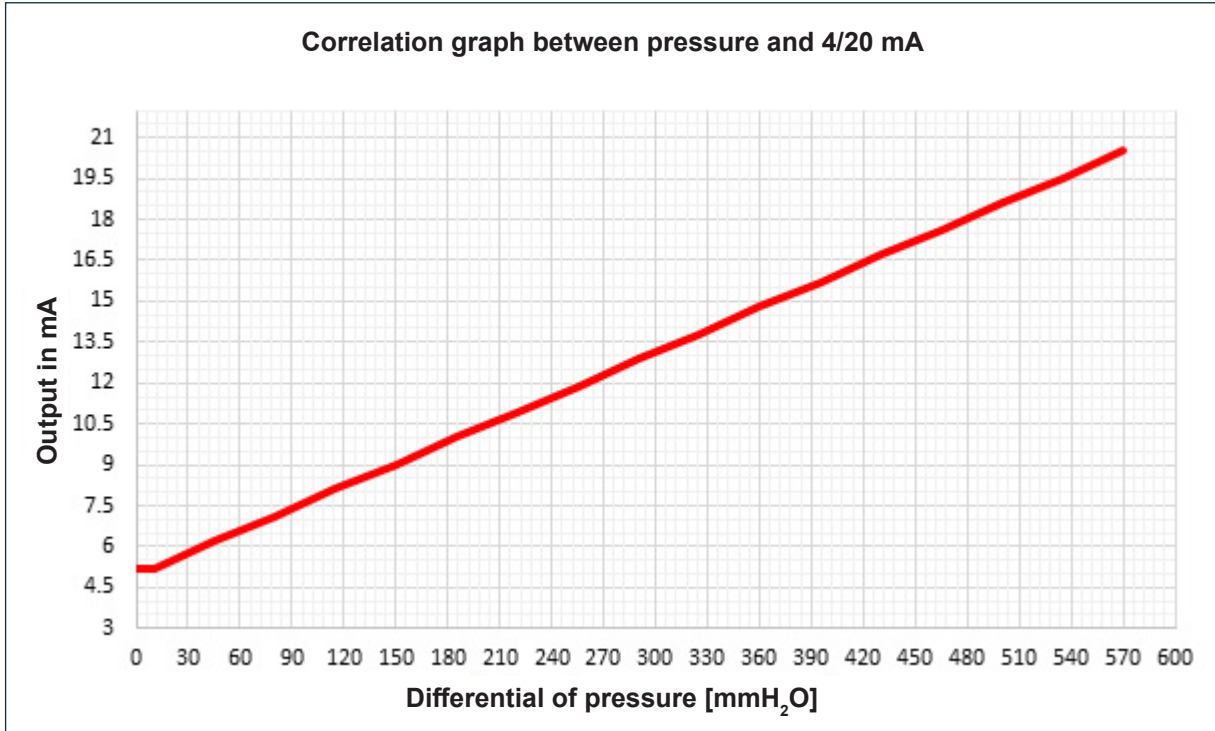

Find below some tabulated values, the rest is directly proportional:

P [mmH ₂ O]	P [KPA]	I [mA]
0	0	5.2
625	6	21



Danger - Warning

It is **FORBIDDEN** to blow or alter the inlet or outlet tubes of the MDPE sensor, since doing so can cause it to break.

To manually check the correct operation of the MDPE signal, proceed as follows:

➤ Connect the tester to the pin 12 and 14:

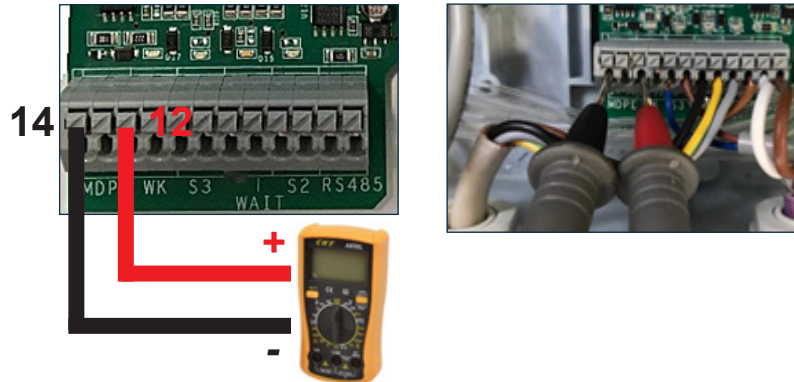

➤ Read the output voltage or current:

Output in VOLT



Output in mA



If the voltage value shown ranges between 3 and 24V and the current value is about 5mA with the hoses disconnected, the electronic board is working properly.

If the voltage value is shown, but the current value it is not, the tester could have problems (e.g. blown fuse).



Important

In the event of reading problems, perform calibration as indicated in the section 4.8.2 MDPE Calibration (page 26).

4.5 How to switch on the electronic board

As soon as the board is powered a voltage value that matches the specifications, a "run test" starts as follows:

- 1) the Power LED indicator light gets lit and the indicator light (LED CLEAN) turns from red into green; the display shows the firmware revision (RV1XX) and READY;
- 2) it is run a compatibility test on the solenoid valves (each corresponding LED blinks):
FILCONTROL CONNECT checks if the program set is aligned to the number of solenoid valves connected:

if it is not, an ALARM message is shown; by pressing for 5 seconds the key "SEL",  and then again

the key "SEL" : ERR1 is shown.

At the end of the "run test", when the contact S2 is closed, the board starts the normal cleaning regardless of the fact that alarms have tripped, on condition that "WAIT" is not closed and the contact S3 is not active, depending on how it has been configured (*see section 4.9.4. - page 33*).



Important

When FILCONTROL runs the program "0" (test program), the red LED on the board is lit.

4.6 Main controls

CLEANING: it starts after the contact S2 closes, the display shows the message CLEAN (steady);

CLEANING AT THE END OF CYCLE: starts automatically, after the contact S2 has opened; the display shows CLEAN flashing on the screen;

WAIT: it starts after the related contact closes, the display shows the caption WAIT steady on the screen;

S3: it is activated by an external signal; the display shows EXT.



4.7 INFO mode



Important

The electronic board shows always the value of Δp expressed in the unit of measurement selected.

The Info Mode allows reading the values set and detected by the board.

To enter this mode, press "SEL"  for 5 seconds; in the bottom right corner the display shows **MAINT** (flashing). Use the key "SEL"  to scroll through the following parameters:

- > Operation hours
- > Alarms (if any)
- > ΔP
- > Air consumption
- > Program set
- > Pause time
- > Blowing time
- > Number of cleaning cycles at the end of cycle
- > READ / ACTIVE
- > MDPE MIN
- > MDPE MAX
- > MDPE HIGH

No programming is possible on this page.

4.8 Simplified programming

To access the board parameters programming menu, press "ENTER"  for 5 seconds, the displays shows "MAINT" steady on the screen.

4.8.1 How to customise a program



Danger - Warning

**Warning: make sure the control board is powered before starting to program it.
The solenoid valve cables must be connected and the S2 contact must be opened.
The programming must be performed with the cover closed, by an operator previously trained and specialized.**

The programs from 0 to 63 described in the section **4.8.4 Pre-set programs (page 29)** contain information on the number of solenoid valves, on the solenoid valves management type, and on the differential pressure values (max., min., high).







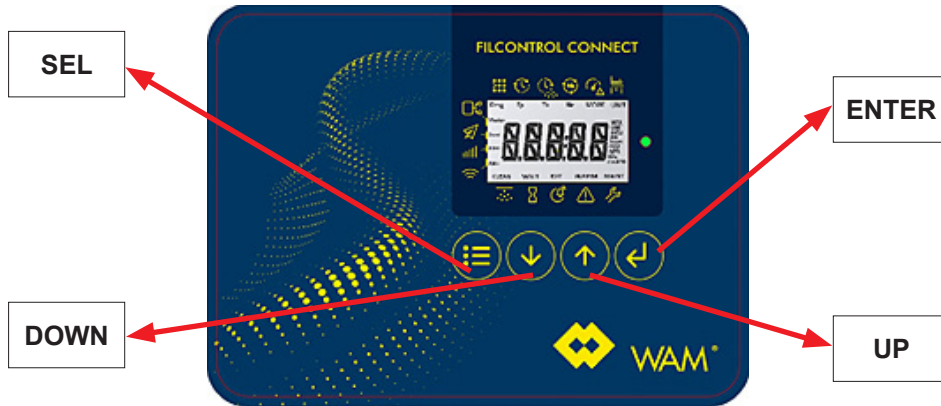







How to customise a program

If the board is supplied along with the filter, the programs will be pre-set according to the type of machine; if supplied as spare part, the control board will be set on the program 0. If in the first case the installer decides how to customise the program, in the second case, to be able to run correctly the cleaning of the filter it is necessary to customise the program.

The main controls of the board are given below:



Important

Prior to starting the programming, disable the cleaning, i.e. the contact S2 key must be in the open position.

ACTION	INFORMATION SHOWN ON THE DISPLAY
1. Press and hold the "ENTER" key  for 5 seconds until "MAINT" is shown steady on the lower part of the display. Simultaneously, it is shown the program which has been pre-set on the control board.	
2. Press the "ENTER" key  to change the selected parameter; the program number (in this case "3") will blink on the display.	
3. Press the "UP" key  until you find the number of the program to be set that flashes.	
4. Press the "ENTER" key  ; the selected program number shown on the display stops flashing.	
5. Press the "SET" key  until the display shows the message "ABORT".	
6. Press the "SET" key  until the display shows the message "SAVE".	
7. Press the "ENTER" key 	
At the end of this procedure, the program is modified correctly.	



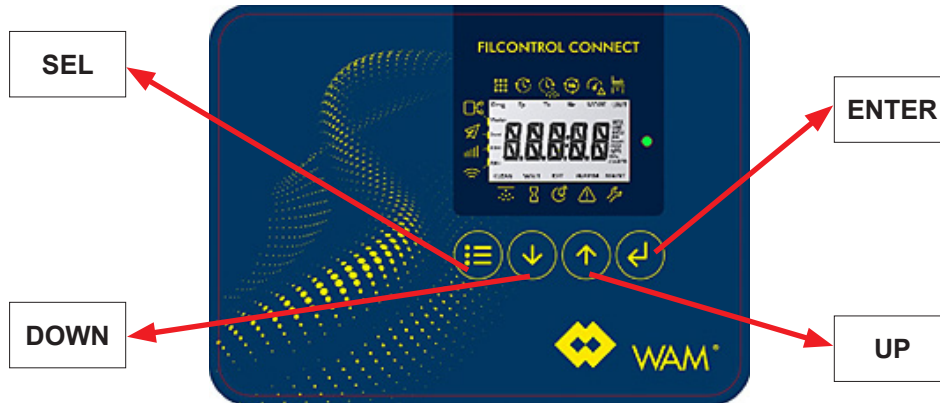







4.8.2 MDPE Calibration

When the display shows P>0 **WITHOUT** any air flow passing through the filter, it is necessary to calibrate the sensor MDPE.

Important

Prior to starting the programming, disable the cleaning cycle, i.e. the contact S2 key must be in open position.

Disconnect the pipes connected to the sensor.

ACTION	INFORMATION SHOWN ON THE DISPLAY
1. Press and hold the "ENTER" key  for 5 seconds until "MAINT" is shown steady on the lower part of the display. Simultaneously, it is shown the program which has been pre-set on the control board.	
2. Press the "SEL" key  until the display shows the message "READ".	
3. To change the selected parameter, press the key "ENTER"  ; the message "Read" flashes on the display.	
4. Press the "UP" key  until you find the message "CALIB" that flashes on the display.	
5. Press the "ENTER" key  ; the message "CALIB" shown on the display stops flashing.	
6. Press the "UP" key  for 5 seconds until the display shows P=0.	
At the end of this procedure, the calibration is finished successfully.	

Important

N.B.: Do not blow or alter the tubes at the inlet or outlet of the MDPE sensor, since it can cause them to break; in case of reading errors, run with the calibration procedure previously described.

4.8.3 Smart cleaning
4.8.3.1 Function

This mode is designed to allow cleaning only when needed, reducing though the air consumption and the strain on the filtering elements.

The parameters linked to smart cleaning are the following:

- > MDPE MIN
- > MDPE MAX
- > MDPE HIGH

Important

When the program is changed, the values previously recorded change depending on the program itself (section 4.8.4 Pre-set programs, page 29).

Check the chart below for further info:

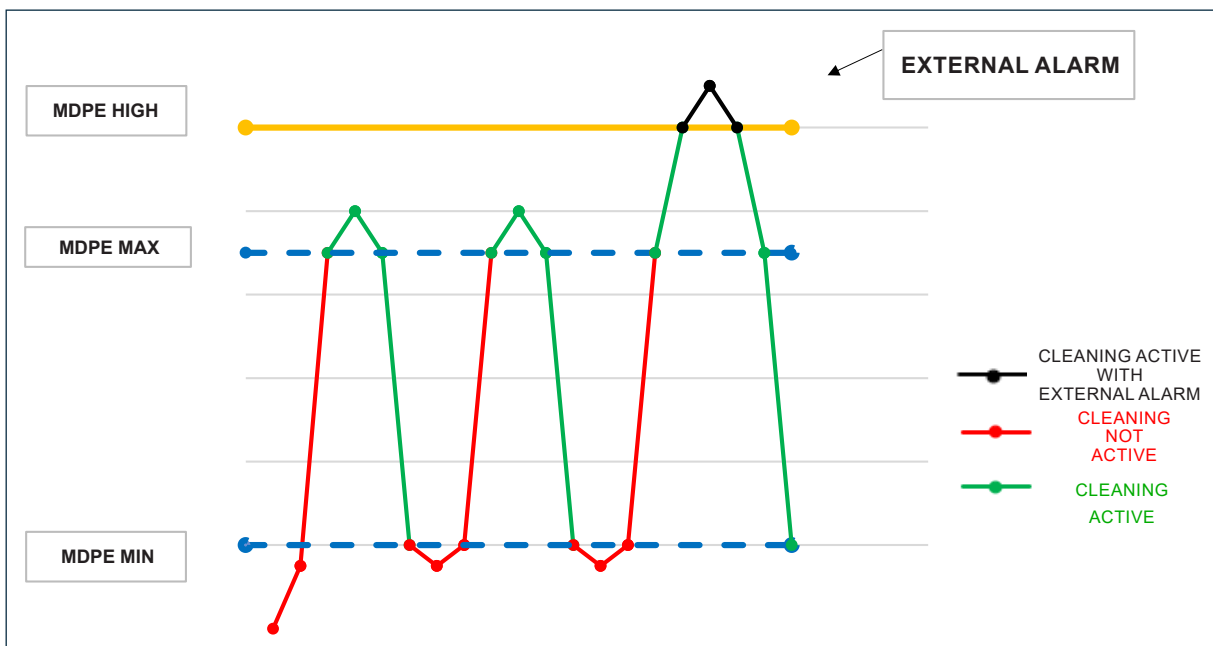
Important







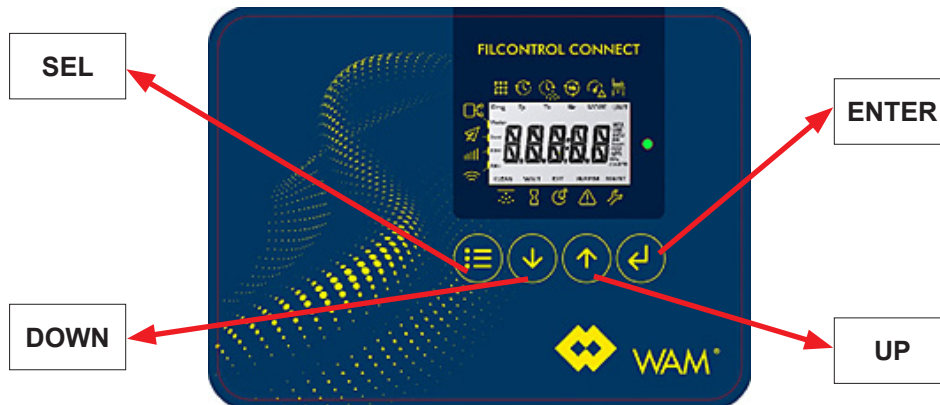



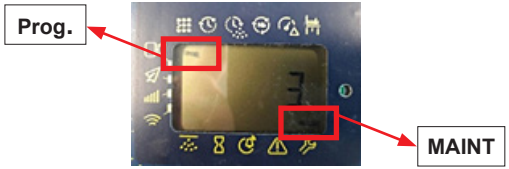

The MDPE MIN, MDPE MAX, MDPE HIGH values can be modified manually (check the section 4.9.2 Custom values - page 32).

4.8.3.2 How to activate the smart cleaning

To activate the smart cleaning, run the following commands:

4.0 FILCONTROL CONNECT

Important

Prior to starting the programming, disable the cleaning, i.e. the contact S2 key must be in the open position.

ACTION	INFORMATION SHOWN ON THE DISPLAY
1. Press and hold the "ENTER" key  for 5 seconds until "MAINT" is shown steady on the lower part of the display. Simultaneously, it is shown the program pre-set on the board.	
2. Press the "SEL" key  until the display shows the message "READ".	
3. Press the "ENTER" key  to change the selected parameter; the "READ" message blinks on the display.	
4. Press the "UP" key  until the display shows the message "ACTI".	
5. Press the "ENTER" key  ; the message "ACTI" shown on the display stops flashing.	
6. Press the "SET" key  until the display shows the message "ABORT".	
7. Press the "UP" key  until the display shows the message "SAVE".	
8. Press the "ENTER" key. 	
The procedure for the activation of the smart cleaning has been successfully completed.	

4.0 FILCONTROL CONNECT
4.8.4 Pre-set programs

The number of pre-set programs depends on the type of the machine supplied:

Prog. (D)	Description	Number [S/V]	Tp [sec]	Ts [msec]	Number of air blows at the end of the cycle	"Tp" End of cycle [sec]	MDPE Max [mmH ₂ O]	MDPE Min [mmH ₂ O]	MDPE High [mmH ₂ O]
0	SELF-TEST	-	5	100	1	5	000	000	000
1	SILAB14	2	56	100	7	5	90	20	400
2	SILAB24	3	39	100	7	5	90	20	400
3	SILOTOPR03	3	28	100	7	5	90	20	400
4	ROUND FILTER FN/FNX (W) POLYPLEAT - 2 S/V	2	28	100	7	5	90	20	200
5	ROUND FILTER FN/FNX (W) POLYPLEAT - 3 S/V	3	28	100	7	5	90	20	200
6	ROUND FILTER FN/FNX (W) POLYPLEAT - 4 S/V	4	28	100	7	5	90	20	200
7	ROUND FILTER FN/FNX (W) POLYPLEAT - 5 S/V	5	28	100	7	5	90	20	200
8	ROUND FILTER FN/FNX (W) POLYPLEAT - 6 S/V	6	28	100	7	5	90	20	200
9	ROUND FILTER FN/FNX (S/C) WITH CARTRIDGES - 1 S/V	1	28	100	7	5	90	20	200
10	ROUND FILTER FN/FNX (S/C) WITH CARTRIDGES - 2 S/V	2	28	100	7	5	90	20	200
11	ROUND FILTER FN/FNX (S/C) WITH CARTRIDGES - 3 S/V	3	28	100	7	5	90	20	200
12	ROUND FILTER FN/FNX (S/C) WITH CARTRIDGES - 4 S/V	4	28	100	7	5	90	20	200
13	ROUND FILTER FN/FNX (S/C) WITH CARTRIDGES - 5 S/V	5	28	100	7	5	90	20	200
14	ROUND FILTER FN/FNX (S/C) WITH CARTRIDGES - 6 S/V	6	28	100	7	5	90	20	200
15	ROUND FILTER FN/FNX WITH BAGS - 1 S/V	1	28	210	5	5	90	20	200
16	ROUND FILTER FN/FNX WITH BAGS - 2 S/V	2	28	210	5	5	90	20	200
17	ROUND FILTER FN/FNX WITH BAGS - 3 S/V	3	28	210	5	5	90	20	200
18	ROUND FILTER FN/FNX WITH BAGS - 4 S/V	4	28	210	5	5	90	20	200
19	ROUND FILTER FN/FNX WITH BAGS - 5 S/V	5	28	210	5	5	90	20	200
20	ROUND FILTER FN/FNX WITH BAGS - 6 S/V	6	28	210	5	5	90	20	200
21	ROUND FILTER FN/FNX WITH ELLIPTIC BAGS- 2 S/V	2	28	210	5	5	90	20	200
22	ROUND FILTER FN/FNX WITH ELLIPTIC BAGS- 3 S/V	3	28	210	5	5	90	20	200
23	ROUND FILTER FN/FNX WITH ELLIPTIC BAGS- 4 S/V	4	28	210	5	5	90	20	200
24	POLYGONAL FILTER FP/FPX (W) POLYPLEAT -3 S/V	3	28	100	7	5	90	20	200
25	POLYGONAL FILTER FP/FPX (W) POLYPLEAT - 4 S/V	4	28	100	7	5	90	20	200
26	POLYGONAL FILTER FP/FPX (W) POLYPLEAT - 5 S/V	5	28	100	7	5	90	20	200
27	POLYGONAL FILTER FP/FPX (W) POLYPLEAT - 6 S/V	6	28	100	7	5	90	20	200
28	POLYGONAL FILTER FP/FPX (W) POLYPLEAT - 7 S/V	7	28	100	7	5	90	20	200
29	POLYGONAL FILTER FP/FPX (W) POLYPLEAT - 8 S/V	8	28	100	7	5	90	20	200
30	POLYGONAL FILTER FP/FPX (W) POLYPLEAT - 10 S/V	10	28	100	7	5	90	20	200
31	POLYGONAL FILTER FP/FPX (T) WITH POCKETS - 3 S/V	3	28	210	5	5	90	20	200
32	POLYGONAL FILTER FP/FPX (T) WITH POCKETS - 4 S/V	4	28	210	5	5	90	20	200
33	POLYGONAL FILTER FP/FPX (T) WITH POCKETS - 5 S/V	5	28	210	5	5	90	20	200
34	POLYGONAL FILTER FP/FPX (T) WITH POCKETS - 6 S/V	6	28	210	5	5	90	20	200
35	POLYGONAL FILTER FP/FPX (T) WITH POCKETS - 7 S/V	7	28	210	5	5	90	20	200
36	POLYGONAL FILTER FP/FPX (T) WITH POCKETS - 9 S/V	9	28	210	5	5	90	20	200
37	POLYGONAL FILTER FP/FPX (T) WITH POCKETS - 10 S/V	10	28	210	5	5	90	20	200
38	POLYGONAL FILTER FP/FPX (T) WITH POCKETS - 12 S/V	12	28	210	5	5	90	20	200



4.0 FILCONTROL CONNECT

Prog. (D)	Description	Number [S/V]	Tp [sec]	Ts [msec]	Number of air blows at the end of the cycle	"Tp" End of cycle [sec]	MDPE Max [mmH ₂ O]	MDPE Min [mmH ₂ O]	MDPE High [mmH ₂ O]
39	HOPPERTOP - 1 S/V	1	28	100	7	5	90	40	400
40	FLT04	4	10	100	7	5	60	20	150
41	FLT06	6	10	100	7	5	60	20	150
42	FLT08	8	10	100	7	5	60	20	150
43	FLT12	12	10	100	7	5	60	20	150
44	FLT24	24	10	100	7	5	60	20	150
45	HOPPERJET (W) - POLYPLEAT - 1 S/V	1	28	100	7	5	90	40	400
46	HOPPERJET (W) - POLYPLEAT - 2 S/V	2	28	100	7	5	90	40	400
47	HOPPERJET (T) - WITH POCKETS - 1 S/V	1	28	210	7	5	90	40	400
48	HOPPERJET (T) - WITH POCKETS - 2 S/V	2	28	210	7	5	90	40	400
49	INSERTABLE FOR NEGATIVE PRESSURE FPN/FPNX (T) WITH POCKETS - 6 S/V	6	56	210	7	5	90	20	300
50	INSERTABLE FOR NEGATIVE PRESSURE FPN/FPNX (T) WITH POCKETS - 9 S/V	9	56	210	7	5	90	20	300
51	INSERTABLE FOR NEGATIVE PRESSURE FPN/FPNX (T) WITH POCKETS - 12 S/V	12	56	210	7	5	90	20	300

4.0 FILCONTROL CONNECT
4.9 Advanced programming
4.9.1 Editable values

To change any settable value of the electronic control board, press and hold the "ENTER" key for 5 seconds until "MAINT" is shown steady on the lower part of the display.

All editable values are listed below in the order shown on the display of the board:

Programmable values	Description	Range		Default
		settable values	units	
Program	Section 4.8.4 Pre-set programs (page 29)	From 0 to 63	-	Depends on the machine type
Pause time	Parameters affected by modifications of the program	From 0 to 250	s	According to the selected program
Blowing Timing		from 5 to 400	ms	According to the selected program
Number of cleaning cycles at the end of cycle		From 0 to 10	-	According to the selected program
READ/ACTIVE/CALIBRATE		READ/ACTIVE/CALIBRATE	-	READ
MDPE MIN		From 0 to 600	mmH ₂ O	According to the selected program
MDPE MAX		From 0 to 600	mmH ₂ O	According to the selected program
MDPE HIGH		From 0 to 600	mmH ₂ O	According to the selected program
UNIT		British Imperial System	Kpa and CFM	-
	Metric system	Nm ³ /h and mmH ₂ O	-	
NOD: (indicates the RS485 MODBUS node)	accessible to the manufacturer only	0;1;2;3	-	NOD:33
	Slave communication	From 4 to 99	-	
PR: (indicates the protocol)	RS485	0	-	0 (RS485)
	Wi-Fi (Hotspot 192.168.2.1)	1	-	
	Wi-Fi (Client DHCP! First configure your network)	2	-	
	GPRS	3	-	
BDR: (indicates the communication speed RS485 MODBUS)	communication speed RS485 MODBUS	0-9 between 1200 and 38400	-	9600
S3: (indicates the external alarm input S3)	The system ignores S3	0	-	0 (the system ignores S3)
	The system uses the sensor S3 as normally open (JUMPER=ALARM)	1	-	
	The system uses the sensor S3 as normally closed (JUMPER=OK)	2	-	







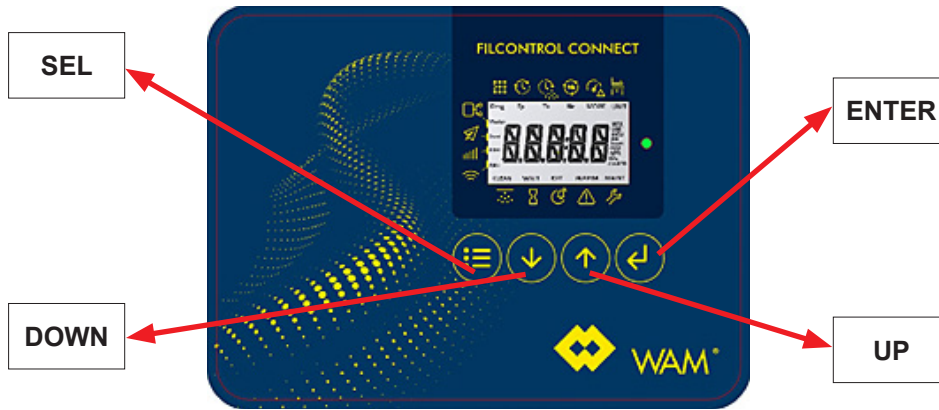



4.9.2 Custom values

In addition to the basic functions already described in the section **4.8.1 How to customise a program (page 24)**, all parameters given in the table **section 4.9.1 Editable values (page 31)** can be customised.

Proceeds as follows to change the programmable values:

Important

Prior to starting the programming, disable the cleaning, i.e. the contact S2 key must be in open position.

ACTION	INFORMATION SHOWN ON THE DISPLAY
1. Press and hold the "ENTER" key  for 5 seconds until "MAINT" is shown steady on the lower part of the display. It is shown the program which has been pre-set on the control board.	
2. Press the "SEL" key  to display the value to be changed (check the list given in the table at page 31 in the column "programmable values").	
3. Press the "ENTER" key  to change the selected parameter; the value will blink on the display.	
4. Press the "UP" key  to change the value (consider the range associated to the table at page 31 in the column "settable values").	
5. Press the "ENTER" key  ; the value selected stops flashing.	
6. Press the "SET" key  until the display shows the message "ABORT".	
7. Press the "UP" key  until the display shows the message "SAVE".	
8. Press the "ENTER" key  .	
ONLY at this point the value changing procedure is successfully completed.	

4.9.3 End of cycle cleaning

The cleaning at the end of the cycle has the function of performing cleaning cycles with no reversed air flow, thus increasing the efficiency of the same. It activates when the contact S2 is opened after its closure, and, however, after all solenoid valves have been activated.



Important

In all programs available, the pause time of the cleaning at the end of the cycle (between one blow and the next) is set to 5s and CANNOT be changed. Only the number of cycles can be set (section 4.9.2 Custom values - page 32).

To be able to disable the cleaning at the end of the cycle, set the number of cycles for the final cleaning to 0 as described in section 4.9.2 Custom values (page 32); in this way, when the contact S2 opens, the cleaning will continue up to the last solenoid valve; then the control board goes in stand-by.

4.9.4 External signal S3

The external alarm S3 has the purpose to block the cleaning of the filter. It may be associated with any coherent sensor (in charge of the customer).

This alarm can be set according to the 3 modes:

- 0: The system ignores S3.
- 1: The system uses the sensor S3 as normally open (JUMPER=ALARM).
- 2: The system uses the sensor S3 as normally closed (JUMPER=OK).

In order to perform the above setting, select (by following the procedure given in the **section 4.9.2 Custom values (page 32)** the value of the parameter S3, depending on the need.

4.8.5 RS485 Communication

The MODBUS communication function of the FILCONTROL CONNECT allows the electronic control board to get interfaced with the PLC control systems through a universal protocol.

Communication protocol: RS485, MODBUS 9600,8,N,1

4.9.5.1 Connection

The boards must be connected through the terminals 3 and 4 with twisted pair.

The interface on the filters is opto-insulated with insulation capacity of about 4KV.

Since it does not envisage repeaters management (only connection D+ and D-), the filters number and the distances are limited to one way only according to the MODBUS standard.

Example of connection:

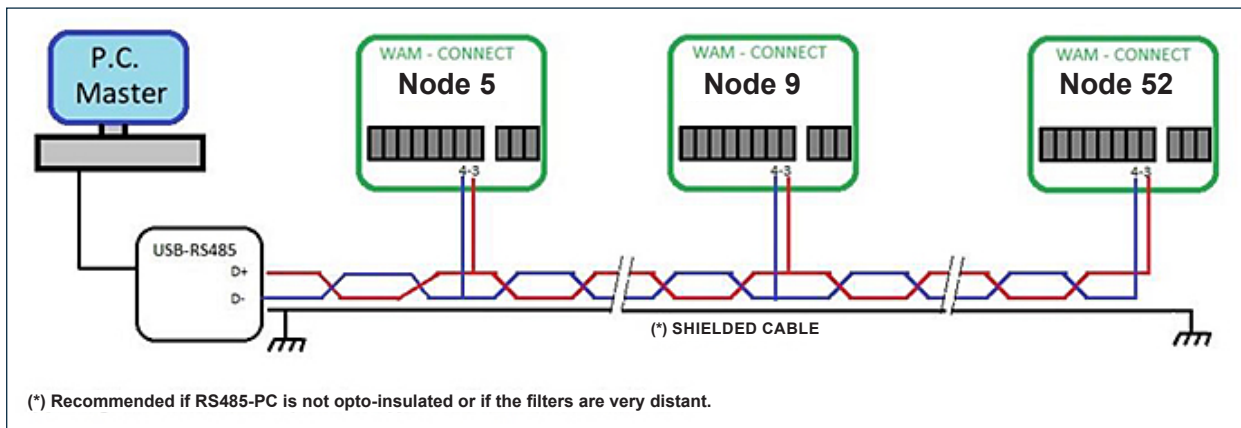

4.9.5.2 Set-up - Conflicts with other options

The priority of the Wi-Fi and GPRS can generate corrupted MODBUS due to the physical switching of the communication.

N.B.: As a consequence, if two protocols are used simultaneously, corrupted frames detecting algorithms must be provided.

- Setup → **PR=0**

The filter only communicates in MODBUS mode (recommended).

- Setup → **PR=1,2**

The filter communicates every 1 second with the Wi-Fi module, the MODBUS communication is still possible in the remaining time. Provision should be made in the network management for logics meant to recover lost messages sent by the filter due to the temporary management of the Wi-Fi module.

- Setup → **PR=3,4**

Every 5 seconds the filter queries the GPRS module, then manages and/or sends messages to the phones; however, MODBUS communication is still possible in the remaining time. Provision should be made in the network management for logics meant to recover lost messages sent by the filter due to the temporary management of the GPRS module.

4.9.5.3 Set-up - MODBUS Data Reading

Function 3 MODBUS protocol:

1 Byte	Default "33" (See Set-up)
1 Byte	3
2 Byte (High, Low)	0x0000 ... 0xFFFF
2 Byte (High, Low)	0 ... 125

Example of logs 1000 and 1001 request:

1 Byte	Default "33" (See Set-up)
1 Byte	0x03
1 Byte	2 * log
2 Byte * log	Value Array

Example of logs 1000 and 1001 request:

0x11	0x03	0x03	0xE8	0x00	0x02	Chk-H	Chk-H
------	------	------	------	------	------	-------	-------

Response		
Slave Address	1 Byte	Default "33" (See Set-up)
Function Code	1 Byte	0x03
Byte Count	1 Byte	2 * log
Log Value	2 Byte * log	Value Array

As a response to request for the logs 1000 and 1001:

0x11	0x03	0x04	0x12	0x34	0x56	0x78	Chk-H	Chk-H
------	------	------	------	------	------	------	-------	-------

4.0 FILCONTROL CONNECT
List of readable logs

Address	Log	Meaning
1000	Filter status	Bit groups, see the following description
1001	MDPE Reading	0...50 0,0KPa...5,0KPa
1002	Solenoid Valves Window	Bit 0....14 => EV1...EV15; 1=None
1003	Program set	0...63 Program number
1004	Pause Time	Each unit equals 1 Sec.
1005	Blowing time	Each unit equals 10 mSec.
1006	WORK-TIME minutes	Working timer, minutes with S2 active
1007	WORK-TIME hours	Working timer, hours with S2 active
1008	SHOOT - LOW	Number of blows performed 0....65536
1009	SHOOT - HIGH	Number of blows, each unit equals 65536 shots

Filter status log

			Ev	Ev	Ev	Ev	-	WK	EX	W	S2	M	M	F	F
--	--	--	----	----	----	----	---	----	----	---	----	---	---	---	---

FF=00	Filter in "Stand-By"
FF=01	Filter in "Clean"
FF=10	Filter in "End of Clean"
FF=11	Filter in Alarm
M=00	MDPE value lower than the minimum
M=01	MDPE normal value
M=10	MDPE high value
M=11	MDPE in alarm value
S2=0,1	Input S2, 1=active, 0=Not Active
W=0,1	Input WAIT, 1=active, 0=Not Active
EX=0,1	Input Ext (S3 or alarm), 1=active, 0=Not Active
WK=0,1	Output WK, 1=active, 0=Not Active
Ev=0....15	Last solenoid valve that has blown, 0=StandBy, n=EVn

Danger - Warning

If several filters are monitored by one PC, the nodes 0, 1, 2, 3 and 33 are reserved for specific functions, therefore they cannot be used.

Configure them on the other nodes; the node 33 can be configured on one filter only.

From the front panel of the FILCONTROL CONNECT select the nodes between 4 and 99 (except for 33, already configured).

4.10 Accessory modules (OPTION)

The FILCONTROL CONNECT electronics requires to fit 2 accessories for remote connection:

(a) GPRS MODULE

The additional GPRS module allows to remotely display, both in automatic mode and upon request, the working parameters of the filter (operation hours, number of blows, pressure, filter status).

The communication is possible through a mobile phone and consists in displaying the STATUS, a REPORT or the EVENTS.

It is not possible to change the programming of the control board by using the GPRS module, but only requiring info.

(b) Wi-Fi MODULE

The additional Wi-Fi module allows displaying remotely the operation parameters of the filter. It is possible to monitor all details available on the control board in INFO mode and *to program* all aspects visible on the control board in programming mode.

The communication is made in real time by mobile phone, PC or tablet.



Important

The Wi-Fi or GPRS modules are alternative and cannot be mounted both on the control board.

4.10.1 GPRS Module

The GPRS module can be supplied as an option at the time of the order or afterwards, but only for FILCONTROL CONNECT control boards.

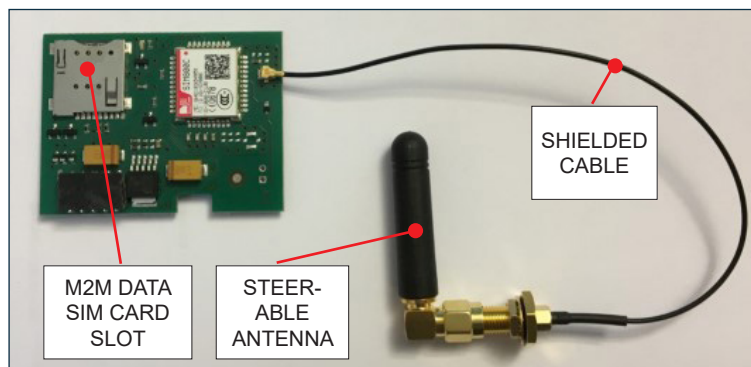

The kit does not include the SIM card for M2M connectivity.

The customer can purchase the M2M SIM cards from a local dealer and fit it into the appropriate slot on the GPRS module.

N.B.: Disable the PIN code before inserting the SIM card.

4.10.1.1 Activation

4.10.1.1.1 Activation

The indications on the installation and activation of the GPRS module are given below.

- 1) Disconnect the board from the main power supply.
- 2) Open the cover by unscrewing the 4 screws.
- 3) Disconnect the flat cable that connects the master card /touch keypad.

4.0 FILCONTROL CONNECT

- 4) Check if the body is provided with the bore for the fastening of the antenna, otherwise, perform a hole having d=6.25 mm on the centre right side of the box.



- 5) Install the antenna shielded cable and secure the nut, checking to make sure the sealing is tight.
6) Insert the GPRS module in the vertical guide, by centring the the pin for exp3 connection.

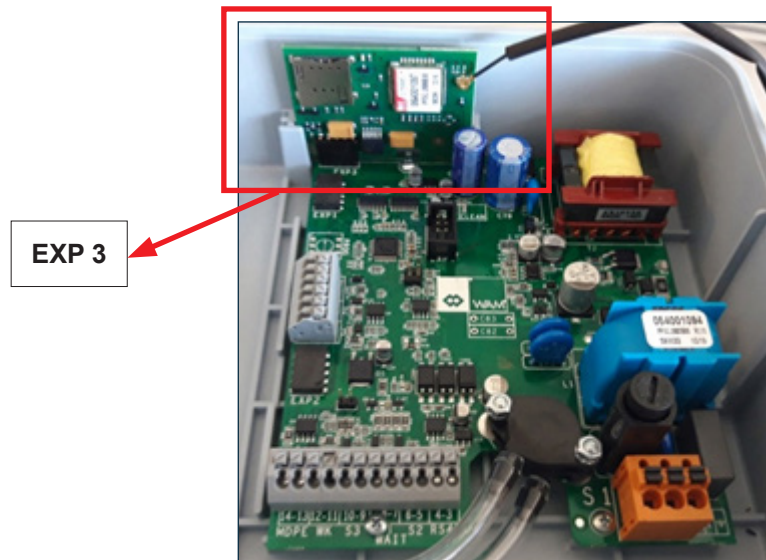

- 7) Fasten the steerable antenna by tightening the related nut.
8) Insert the M2M-type SIM card (the SIM card pin has to be disabled).

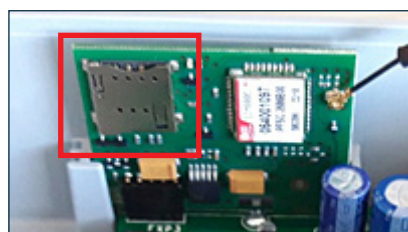

- 9) Close the cover, connect the keypad flat power and communication cable.
10) Power the electronic control board.

4.0 FILCONTROL CONNECT

11) Access the programming menu and set the parameter PR (protocol) on "3" (*Para.4.9.2 Custom values - page 32*).

12) Check if the LCD displays shows the message "GSM".

If the control board replays "INF00" when interrogated upon each start-up, the module has been configured correctly by the operator.

If the above message has not been sent, the connection to the GPRS module has not been properly performed and, as a result, the board does not acknowledges the module.

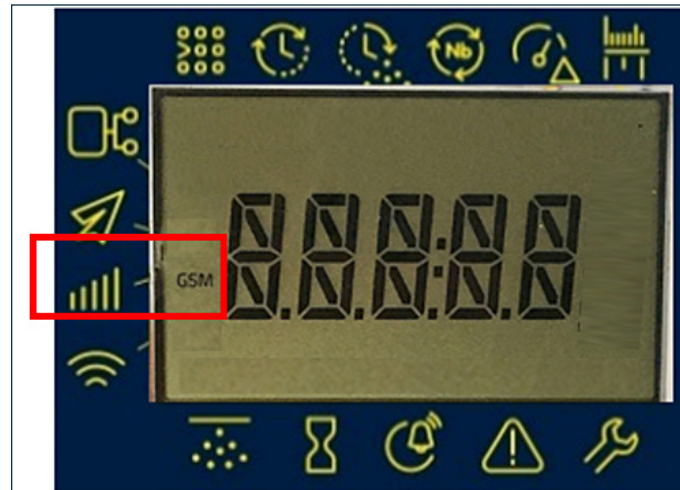

NOTES: (a) The control board envisages maximum 3 users.

(b) Replacing the GPRS module does not require changing the set-up.

(c) Replacing the MASTER board requires to reset the module through SMS.

4.10.1.1.2 Connecting the Control Card to the Mobile Phone

1) STORE ON YOUR PHONE BOOK THE NUMBER OF SIM CARD INSERTED IN THE GPRS MODULE

2) Connect the GPRS MODULE TO THE MOBILE PHONE, by sending from the latter an SMS message with the following text:

TE_n.PW + country code assigned to the cell phone number

where:

n	Number of the user: User 1= "1" User 2= "2" User 3= "3"
PW	Default password for installation: User 1= "1111" User 2= "2222" User 3= "3333"

Example:

TE1.1111+39347123456789

NOTE: Used as standard E.164 that envisages maximum of 14 digits.

4.0 FILCONTROL CONNECT
4.10.1.2 Monitoring
4.10.1.2.1 Changing the password

After the first user registration, it is recommender to change the default user password.

To change your password, send the following SMS:

PWn.oldPW.newPW.newPW

where:

n	Number of the user: User 1= "1" User 2= "2" User 3= "3"
oldPW	Default password for installation: User 1= "1111" User 2= "2222" User 3= "3333"
newPW	New Password

Example:

PW1.1111.Abs8.Abs8

4.10.1.2.2 GPRS status request

It is possible to require the STATUS of your filter by sending a request via SMS using the command:

STn.PW

n	Number of the user: User 1= "1" User 2= "2" User 3= "3"
PW	Password

After this command has been sent, the filter responds with the message below:

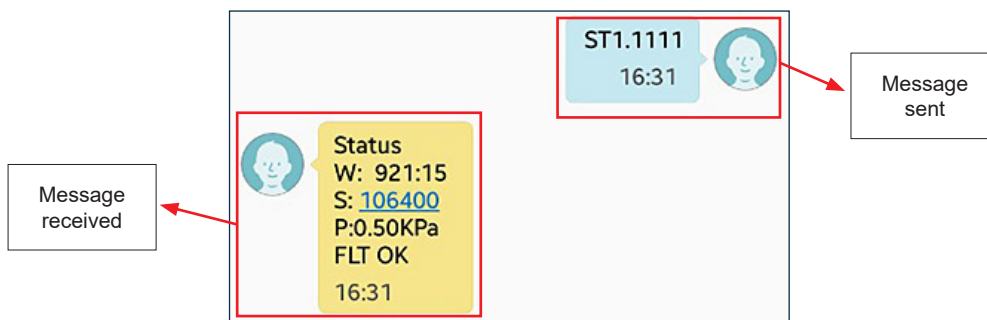

W:	number of operation hours up to the time the message has been sent
S:	number of blows performed
P:	Delta pressure P in mmH ₂ O / KPa
FLT	Status of the filter → OK or alarm

4.0 FILCONTROL CONNECT
4.10.1.2.3 Request for reports on recent events

It is possible to require the **REPORT** on recent events by sending a request via SMS using the command

RPn.PW

n	Number of the user: User 1= "1" User 2= "2" User 3= "3"
PW	Password

After this command has been sent, the filter responds with the message below:

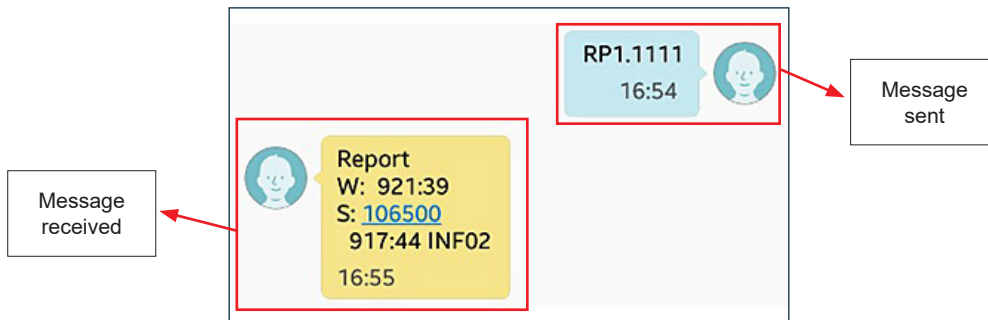

W:	number of operation hours up to the time the message has been sent
S:	number of blows performed
number of operation hours up to the time the last event has occurred	Event

To identify the nature of the event, check the **section 4.11.3 Errors/GPRS Info (page 47)**.

4.10.1.2.4 How to manage the notifications

To receive automatically reports or notifications on the events, assign to the user a notification mode. The command that allows you to manage the notifications is:

MDn.PWt

n	Number of the user: User 1= "1" User 2= "2" User 3= "3"
PW	Password
t	Type of notification: between 0 and 7

4.0 FILCONTROL CONNECT

The types of notification "t" available are:

Notification ID	Description
0	No Notification
1	Report every 40 operation hours
2	Report every 160 operation hours
3	Report every 320 operation hours
4	Events notification
5	Report every 40 operation hours and Events
6	Report every 160 operation hours and Events
7	Report every 320 operation hours and Events

The logics provide that when it is entered a value "T" from 1 to 3, a report is sent (**section 4.10.1.2.3 Request for reports on recent events - page 40**) every xxx operation hours (check the table above). When it is entered a value "t" from 5 to 7, the control board sends always a report (**section 4.10.1.2.3 Request for reports on recent events - page 40**) every xxx operation hours (check the table above); furthermore, it is sent an automatic message for each event occurred.

For instance:

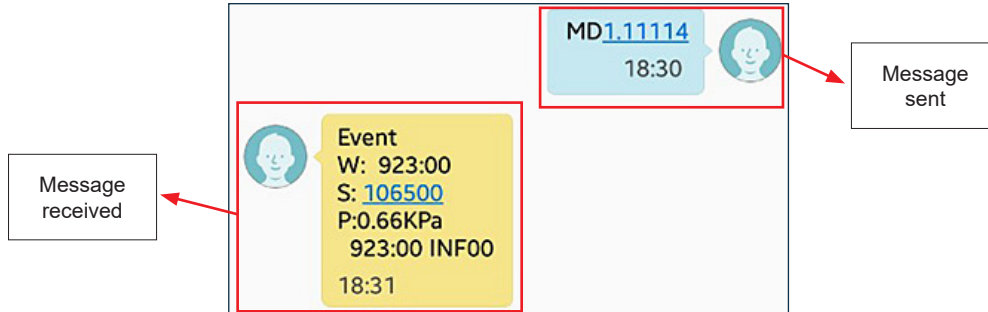

W:	number of operation hours up to the time the message has been sent
S:	number of blows performed at the time of the event
P:	Δp at the time of the event
number of operation hours up to the time the last event has occurred	Event

To identify the nature of the event, check the **section 4.11.3 Errors/GPRS Info (page 47)**.

4.10.2 Wi-Fi Module



Important

To use the Wi-Fi module, select the protocol 1 or 2, depending on whether the connection is via Hot-spot 192.168.2.1 or with DHCP Client!

First, configure your network.

To modify it, use the procedure given in the section 4.9.2 Custom values (page 32).

The module is inserted in the control board in the position indicated in the image:

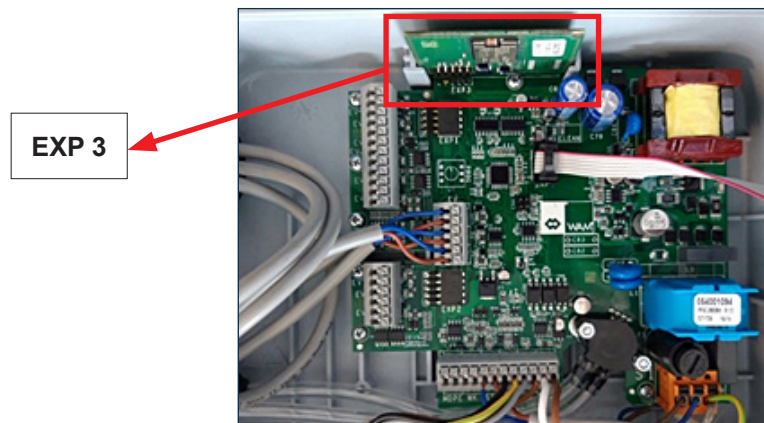

Once the protocol has been changed to 1 or 2 depending on the need, the Wi-Fi module has been recognised by the control board if the display shows Wi-Fi:

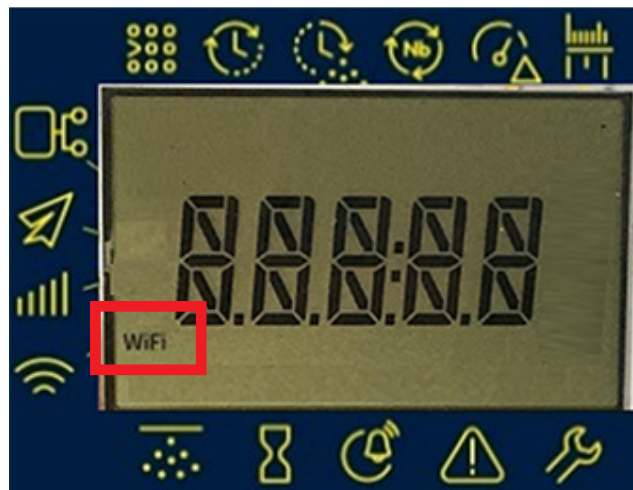

If connected to an option Wi-Fi expansion, the control board sends at regular intervals to the Wi-Fi module the filter status or other information to refresh the Web-Server.



Important

If the operator has not set the correct protocol, the web pages will be empty.

4.10.2.1 HOT-SPOT operation (default)

The module allows Wi-Fi communication between a smartphone, tablet or PC with the electronic board of the filter and makes it possible to:

- **check the filter status;**
- **edit the operating parameters;**
- **check the events log.**

The module creates a network named 'WAM_CONNECT_#####'; the "#" stands for the MAC ADDRESS.

If multiple filters are installed, this allows interrogating each filter independently.

To get connected to the module using your smartphone, tablet or PC, access the set-up of the Wi-Fi and get connected to the network of the filter of interest.

Then open any Internet browser, type the IP address **192.168.2.1** and access the home page of the **web-server**.

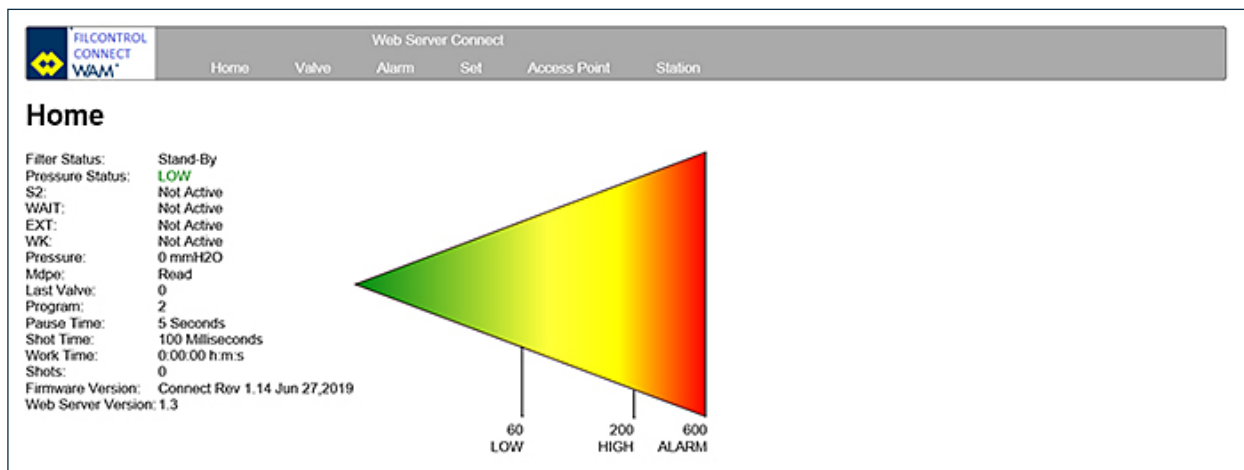

4.10.2.2 WEB page: Home

- a) The "Filter Status" field displays:
 - "Clean" during cleaning;
 - "Stand-by" and "Alarm" when the filter operation has been blocked and is not performing the cleaning.
- b) The "MDPE" field shows respectively the pressure in the format set by the user and the current status (low, normal, high, alarm).
- c) The fields "S2", "WAIT", "EXT" can be "Active" or "Not Active", depending on the physical status of the related inputs.
- d) The "WK" field is "Active" if the filter is in alarm, otherwise it stays "Not Active".
- e) The "Pressure" field displays the differential pressure value measured between the unclean and the clean area of the filter.
- f) The "Last Valve" field indicates the ID of the last solenoid valve which has performed a blow, if the status of the filter is "clean".
- g) The "Program", "Pause Time" and "Blow Time" fields show the selected program, with pause and blowing timing.
- h) The "Work Time" fields represent the operation hours counters and indicate, respectively, how many hours and minutes the input "S2" and the filter cleaning have been active, and how many blows have been actually performed.
- i) The "Firmware Version" field indicates the firmware version installed on the board.
- j) The "Web Server Version" field indicates the firmware version installed on the Wi-Fi module.

4.10.2.3 WEB page: Valve

This window shows (green coloured) the solenoid valves that have been identified by the board and grey coloured, those not connected. This map is used to identify the physical address of the solenoid valves in the system.

- from EV01 to EV03 they are connected on the master card;
- from EV04 to EV09 they are connected on the first expansion (option);
- from EV10 to EV15 they are connected on the second expansion (option).

Moreover, if the master board controls the connected boards, the status shown is "Slave"

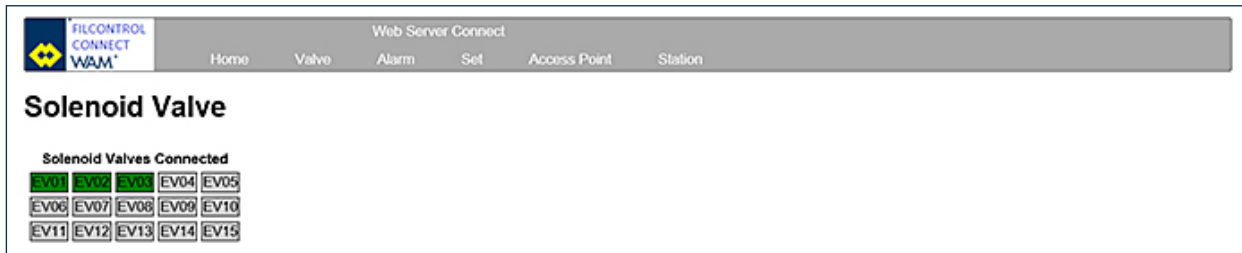

The screenshot shows the 'Solenoid Valve' page in the FILCONTROL CONNECT WEB interface. The page has a navigation bar with 'Home', 'Valve', 'Alarm', 'Set', 'Access Point', and 'Station'. The main content area is titled 'Solenoid Valve' and contains a section 'Solenoid Valves Connected'. This section displays a grid of 15 solenoid valve status indicators, labeled EV01 through EV15. EV01, EV02, and EV03 are highlighted in green, indicating they are connected. EV04 through EV09 are grey, and EV10 through EV15 are also grey, indicating they are not connected.

Solenoid Valves Connected				
EV01	EV02	EV03	EV04	EV05
EV06	EV07	EV08	EV09	EV10
EV11	EV12	EV13	EV14	EV15

4.10.2.4 WEB page: Set

This window allows displaying the filter set-up and permits the operator to modify the cleaning and operation parameters.

- The first column represents the parameter name.
- The second column represents the validity range.
- The third column lists the current value.
- The column with the boxes allows you to enter the new values according to the range column.

These parameters are extensively described in the previous paragraph.

Use the key "Apply" to send the updated values to the FILCONTROL CONNECT board with Wi-Fi Module.

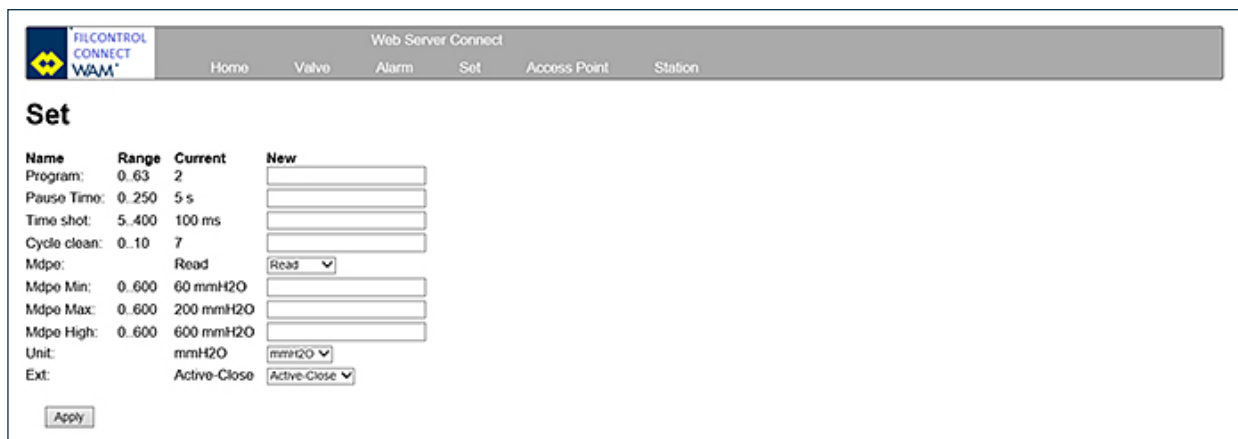

Name	Range	Current	New
Program:	0.63	2	<input type="text"/>
Pause Time:	0.250	5 s	<input type="text"/>
Time shot:	5.400	100 ms	<input type="text"/>
Cycle clean:	0.10	7	<input type="text"/>
Mdpe:		Read	<input type="text"/> <input type="button" value="Read"/>
Mdpe Min:	0.600	60 mmH2O	<input type="text"/>
Mdpe Max:	0.600	200 mmH2O	<input type="text"/>
Mdpe High:	0.600	600 mmH2O	<input type="text"/>
Unit:		mmH2O	<input type="text"/> <input type="button" value="mmH2O"/>
Ext:		Active-Close	<input type="text"/> <input type="button" value="Active-Close"/>

4.10.2.5 WEB page: Access Point

This window displays the Wi-Fi configuration.

The SSID is the network name created by the filter; other fields contain the configurations of the ACCESS POINT:

- default Web-Server 192.168.2.1
- default MASK 255.255.255.0
- default 1 channel with DHCP 192.168.2.2

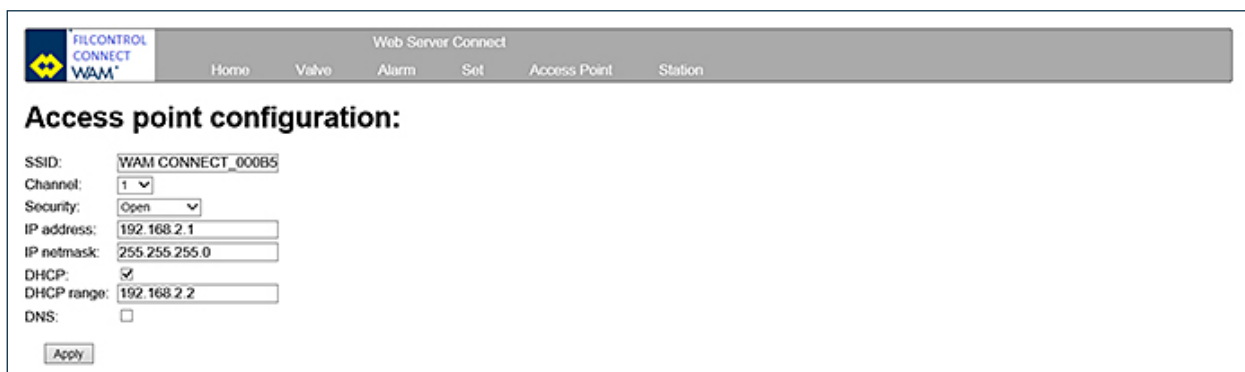

Access point configuration:

SSID:

Channel:

Security:

IP address:

IP netmask:

DHCP:

DHCP range:

DNS:

4.0 FILCONTROL CONNECT
For Android

1. Access the "Settings";
2. Select "Wi-Fi".
3. If not active → enable the "Wi-Fi" function.
4. Wait for the device to show all available networks.
5. Select "WAM_CONNECT_#####"
 - 6. Wait for the message "Connected without the Internet" to be displayed.
 - 7. Close the settings page.
 - 8. To display it, access Google or open in any browser **192.168.2.1**
 - 9. Wait for the browser to open the HOME PAGE of the filter.

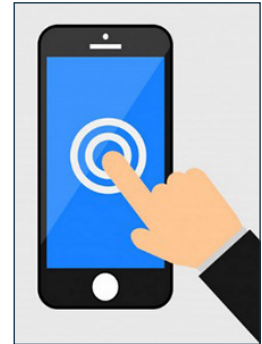
4.11 Errors Log/Info
4.11.1 Errors shown on the display

The errors/info shown on the display of the control board are the following:

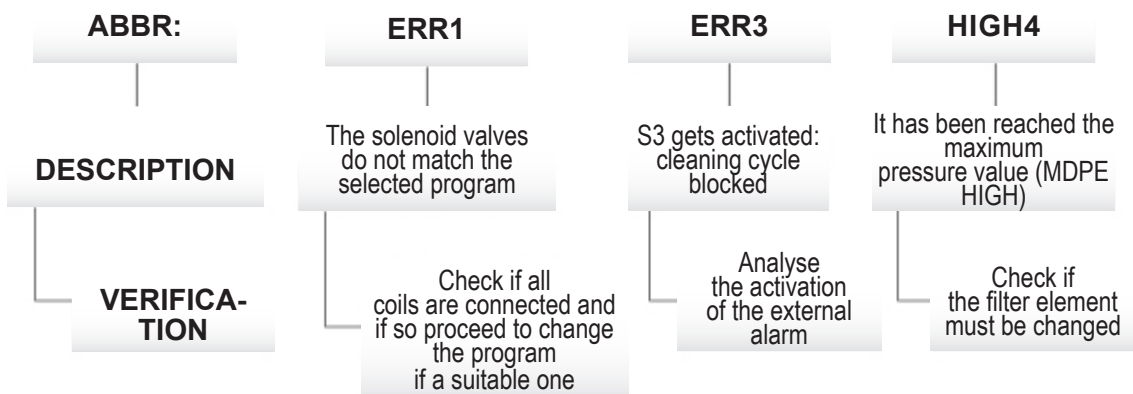

The WK output is a general alarm which trips when at least one of the previous alarms ERR1 ERR3 o HIGH4 has tripped. When active, the caption "ALARM" is shown on the display.

Important

If one of the above mentioned alarms trips, the display shows the caption "ALARM"; to check the nature of the alarm, enter the "INFO" mode by pressing and holding for 5 seconds the key



"SEL" , then again the "SEL" key  ; if alarms are active, it is shown the associated error code.

4.11.2 Wi-Fi Errors/Info

To display remotely the errors, access the page "ALARMS":

This window displays the last 20 events recorded:

- Power-on → whenever the filter is powered it is recorded a change of status;
- Electrovalve NO-MACTH → in case the setting of the filter does not match the number of solenoid valves identified;
- Inputs S2, S3 → it is recorded any status change;
- WK Alarm Output → it is recorded any status change;
- MDPE Sensor → any of the 4 available statuses (low, norm., high, alarm) change is recorded;
- Change SET-UP → if modified by an operator:

N.B.: Use the "Reset alarm" key to clear the events log.

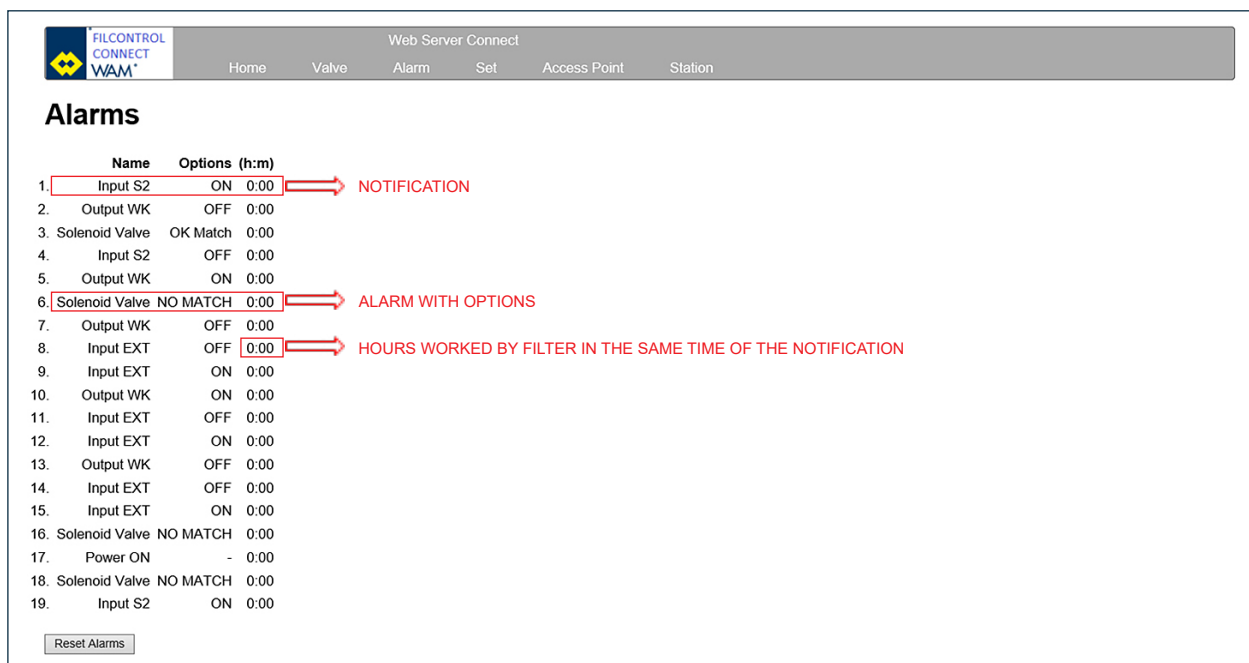

	Name	Options	(h:m)	
1.	Input S2	ON	0:00	→ NOTIFICATION
2.	Output WK	OFF	0:00	
3.	Solenoid Valve	OK Match	0:00	
4.	Input S2	OFF	0:00	
5.	Output WK	ON	0:00	
6.	Solenoid Valve	NO MATCH	0:00	→ ALARM WITH OPTIONS
7.	Output WK	OFF	0:00	
8.	Input EXT	OFF	0:00	→ HOURS WORKED BY FILTER IN THE SAME TIME OF THE NOTIFICATION
9.	Input EXT	ON	0:00	
10.	Output WK	ON	0:00	
11.	Input EXT	OFF	0:00	
12.	Input EXT	ON	0:00	
13.	Output WK	OFF	0:00	
14.	Input EXT	OFF	0:00	
15.	Input EXT	ON	0:00	
16.	Solenoid Valve	NO MATCH	0:00	
17.	Power ON	-	0:00	
18.	Solenoid Valve	NO MATCH	0:00	
19.	Input S2	ON	0:00	

4.11.3 GPRS Errors/Info

As soon as the message is sent, the display shows the caption "Send":

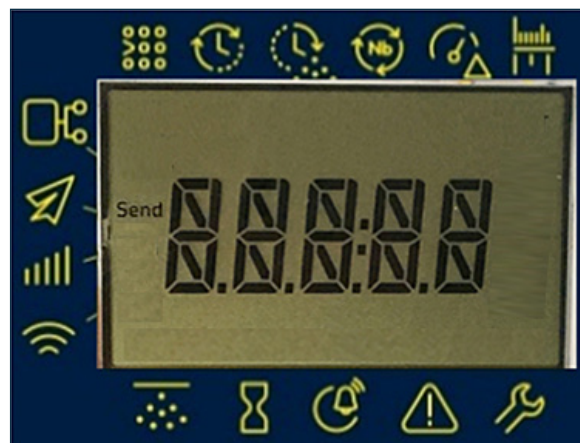



4.0 FILCONTROL CONNECT

CODE	DEFINITION	MESSAGE RECEIVED THROUGH SMS
00	Power On	HH:MM Pwr Up
01	EV-Match	HH:MM ELV OK
11	EV-NoMatch	HH:MM ELV Err
02	S2-Enable	HH:MM S2 ON
12	S2-Disable	HH:MM S2 OFF
03	S3-OK	HH:MM EXT OFF
13	S3-Alarm	HH:MM EXT ON
04	MDPE OK	HH:MM MDPE OK
14	MDPE-ZERO	HH:MM MDPE LOW
24	MDPE HIGH	HH:MM MDPE HIGH
34	MDPE-FAULT	HH:MM MDPE ALARM
05	Display-OK	HH:MM DSY OK
15	Display-Fault	HH:MM DSY ALARM
07	Set-Up	HH:MM CHG SetUp
18	GPRS-User1	HH:MM CHG USER
28	GPRS-User2	
38	GPRS-User3	
09	GPRS-OK	HH:MM GPRS OK
19	GPRS-Fault	HH:MM GPRS ERR
Other	UNDEF	HH:MM ???

* HH:MM = ONLY THE ACTUAL OPERATION HOURS

A1 Declaration of Incorporation



CE DECLARATION OF CONFORMITY

The manufacturer:

WAMGROUP S.p.A.

located in

Strada degli Schiocchi, 12 - I-41124 Modena- Italy

under its own responsibility declares that:

FILCONTROL Electronic Control Board

complies with the requirements imposed by the following Directives:

Directive 2014/30/CE of the European Parliament and the Council of 26 February 2014 on the harmonisation of the laws of the Member States relating to electromagnetic compatibility;

Directive 2014/35/CE of the European Parliament and the Council of 26 February 2014 on the harmonisation of the laws of the Member States relating to the making available on the market of electrical equipment designed for use within certain voltage limits.

Harmonized standards, national standards and technical regulations in question:

UNI EN ISO 12100: 2010 ; CEI EN 60204 – 1

It is forbidden to operate all these products before the machine, in which they will be installed, is declared in conformity with 2006/42/EC AND SUBSEQUENT AMENDMENTS

They also comply with the Directive 2014/34/EU of 26 February 2014 (ATEX)

CE Ex II 3D Ex tc IIIC T100 °C Dc X

EN 60079-31: 2014

Ambient temperature -20°C / +60°C

The signing company is committed to provide, in response to a reasoned request by national authorities, relevant information on products covered by this declaration, without prejudice to the rights of intellectual property of the manufacturer. The information will be transmitted directly to the national authorities having requested.

Strada degli Schiocchi, 12 - I-41124 Modena- Italy, 01/07/2016

The person authorized to provide
the technical documentation
Vainer Marchesini



The legal representative:

Vainer Marchesini



WAMGROUP S.p.A. - Strada degli Schiocchi, 12 - I-41124 Modena- Italy