



CONCRETE PLANT PARTS

2024



CALL (800) 607-9837
FAX (586) 601-1904



WWW.MPPARTS.COM



1843 TUCKER STREET
ROCK HILL, SC 29730





I know how frustrating it can be to have a mixer truck or a concrete plant down. As changes take place in the ready mix concrete industry, you have enough headaches finding mixer technicians and truck drivers. At Mixer & Plant Parts, we understand you want to speak with knowledgeable people who know concrete batch plants and front discharge concrete mixer trucks and how important it is for the right parts to show up at your operation on time every time.

You've probably tried to call and place orders with large corporations and wonder if the person on the other end of the phone even understands what you are asking for. You may have even wondered if they even care about you as a human being.

Well, we've built Mixer & Plant Parts to deliver the peace of mind you need and to stay "Ready Mix Tough" when customer service is weakening all around you. We've built a "Ready Mix Tough" team who is:

- For YOU
- For Each Other
- For the Community - AND -
- For Making a Difference in the World

Meet Jake, Marc, and John who manage the excellent teams in our distribution centers in Grand Rapids, MI, Arlington, TX, and Rock Hill, SC and ensure your parts are assembled, picked, packed and shipped with extraordinary care.

Meet Jamie, the manager of our amazing sales team who have years of experience in the ready mix concrete and heavy duty trucking industry and are here to guide you to the right parts and deliver the peace of mind you and your company deserves. These folks are phenomenal at guiding customers to the right parts for their front discharge mixers, rear discharge mixers, and heavy duty trucks

I'm also pleased to introduce Dan, leading a great team in our accounting department who work with your owners and bookkeepers to align our books and to deliver your invoices and statements on time every time.

Also please say hello to our operations, development, marketing, and information technology teams with Hannah, Mandy, Andrew, and myself - who are dedicated to leading our continually MProving organization with generosity and Love...yep...I said Love. Our goal is that in every interaction with MPParts, you'll feel a sense of belonging, recognition, peace of mind and receive an incredibly remarkable experience you can't wait to tell your friends and family about.

Brandon Syler - CEO, MPParts
brandon@mpparts.com

WEIGHTS AND MEASURES

UNIT	MAY BE SEEN AS
Feet	Foot, Ft, '
Gallon	Gal
Gigabytes	Gigs, Gbs, GB
Holes	Hls, HL
Inches	In, "
Inner Diameter	ID
Leafs	Lf
Length	L, lgth, Long
Liters	L, Ltrs
Millimeters	mm
Ounces	Oz
Outer Diameter	OD
Pieces	Pc, Pcs
Pounds	lbs
Quart	qt
Threads	Thrd
Tons	tonne
Voltage	V
Watts	W

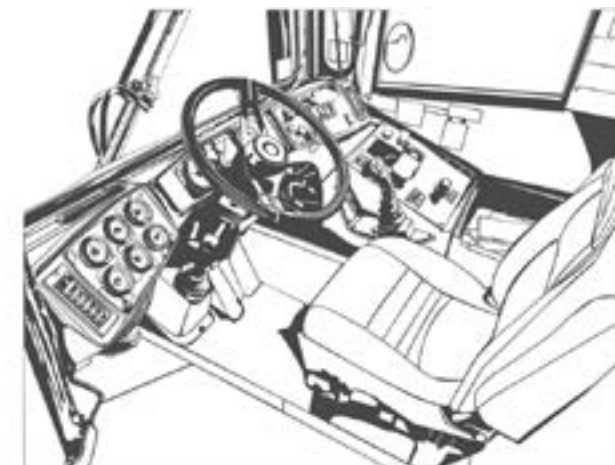

**LH/RH is always from driver perspective.
So LH = roadside and RH = curbside**

.....
**Left Side can be seen as:
Left Side, LS, Left Hand, LH, Roadside, RDSD**

.....
**Right Side can be seen as:
Right Side, RS, Right Hand, RH, Curbside, CBSD**

AERATION COMPONENTS

SOLENOID VALVES

	BRAND	PART #	DESCRIPTION	LINK
1	Stephens	6313D000PM112DA	Single Solenoid Mac Valve Without the Base	link
2	Stephens	6333D000PM112DA	Double Solenoid Valve Without Base	link
3	Stephens	55B12PI112CA	MAC Valve Assembly	link
4	Stephens	912BPM112CA	120VAC Air Valve-Single Solenoid	link

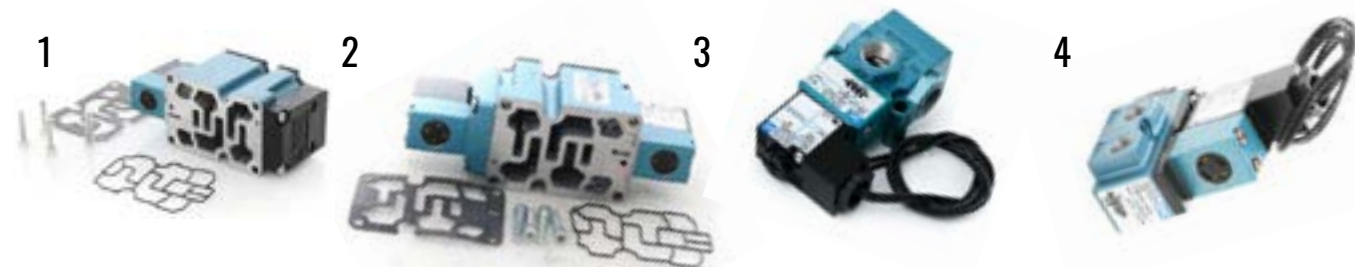

STEPHENS REPAIR KITS

BRAND	PART #	DESCRIPTION	LINK
Stephens	K63016	Single Solenoid Repair Kit - MAC New Style	link
Stephens	K63019	Double Solenoid Repair Kit - MAC New Style	link
Stephens	K352151	Solenoid Repair Kits - Schraeder Bellows	link

BRAND	PART #	DESCRIPTION	LINK
Stephens	L6653921153	Double Solenoid Inching Valve less Sub-Base	link

BRAND	PART #	DESCRIPTION	LINK
Erie Strayer	57633	Valvair Single Solenoid Valve	link
Erie Strayer	57634	Valvair Double Solenoid Valve	link

AERATION COMPONENTS

BRAND	PART #	DESCRIPTION	LINK
Con-E-Co	1168346	Double Solenoid Valve with Individual Base	link
Con-E-Co	145510	3/8in S030 Single Solenoid	link
Con-E-Co	145500	1/2in S040-L Single Solenoid	link
Con-E-Co	145520	3/8in SY30-L Double Solenoid	link
Con-E-Co	145530	1/2in SY40-L Double Solenoid	link
Con-E-Co	145512	Over Air Inching Valve for Schrader Bellows	link
Con-E-Co	1262752	Double Solenoid Valve for Schrader Bellows	link
Con-E-Co	145905	Plant Skinner Valve for Parker	link
Con-E-Co	1100409	120 Volt 3/4in In/ Out Skinner Valve for Parker	link
Con-E-Co	1375105	Single Solenoid Assembly for MAC 55 Series	link

BRAND	PART #	DESCRIPTION	LINK
Con-E-Co	145600	3/8in Single/ Double Solenoid Repair Kit	link
Con-E-Co	145610	1/2in Single/ Double Solenoid Repair Kit	link

BRAND	PART #	DESCRIPTION	LINK
Con-E-Co	145771	Air Valve with .75in Ports (Use with Up/ Down Shroud)	link
Con-E-Co	1237174	120 Volt Valve Air Coil	link
Con-E-Co	145810	3/8in Batch Plant Air Valve Exhaust Muffler	link
Con-E-Co	145820	1/2in Batch Plant Air Valve Exhaust Muffler	link
Con-E-Co	145822	3/4in Batch Plant Air Valve Exhaust Muffler	link
Con-E-Co	145779	1/8in Adjustable Batch Plant Air Valve Exhaust Muffler	link
Con-E-Co	145780	1/4in Adjustable Batch Plant Air Valve Exhaust Muffler	link
Con-E-Co	145800	3/8in Adjustable Batch Plant Air Valve Exhaust Muffler	link
Con-E-Co	145790	1/2in Adjustable Batch Plant Air Valve Exhaust Muffler	link
Con-E-Co	145803	1/2in Hose x 3/8in NPT Flow Control Valve	link
Con-E-Co	145802	1/2in Hose x 1/2in NPT Flow Control Valve	link

AERATION COMPONENTS



26072525



26072457A

BRAND	PART #	DESCRIPTION	LINK	BRAND	PART #	DESCRIPTION	LINK
McNeilus	26072525	Single Solenoid with Manifold	link	McNeilus	26072457A	Single Mac Valve with Individual Base	link
McNeilus	10072558	Single Mac Valve Seal Kit	link	McNeilus	10072558	Single Mac Valve Seal Kit	link



26072557



26072526

BRAND	PART #	DESCRIPTION	LINK	BRAND	PART #	DESCRIPTION	LINK
McNeilus	26072557	Single Mac Valve without Base	link	McNeilus	26072526	Double Solenoid with Manifold	link
McNeilus	10072558	Single Mac Valve Seal Kit	link	McNeilus	10072554	Double Mac Valve Seal Kit	link

AERATION COMPONENTS

BRAND	PART #	DESCRIPTION	LINK
McNeilus	26072452A	Double Mac Valve with Individual Base	link
McNeilus	10072554	Double Mac Valve Seal Kit	link

BRAND	PART #	DESCRIPTION	LINK
McNeilus	26072552	Double Mac Valve without Individual Base	link
McNeilus	10072554	Double Mac Valve Seal Kit	link



BRAND	PART #	DESCRIPTION	LINK	BRAND	PART #	DESCRIPTION	LINK
McNeilus	1108380* (1, 3)	Single-Solenoid Stand-Alone Base	-	McNeilus	1108378* (1, 3)	Single Valve with Individual Base	link

* (1) [1108385](#) Single Valve Seal Kit works with part numbers 1108380, 1108378, 1108388

(2) [1108386](#) Double Valve Seal Kit works with part numbers 1108381, 1108379, 1108389

(3) [1108387](#) Solenoid/ Pilot Valve works with part numbers 1108380, 1108378, 1108388, 1108381, 1108379, 1108389

AERATION COMPONENTS

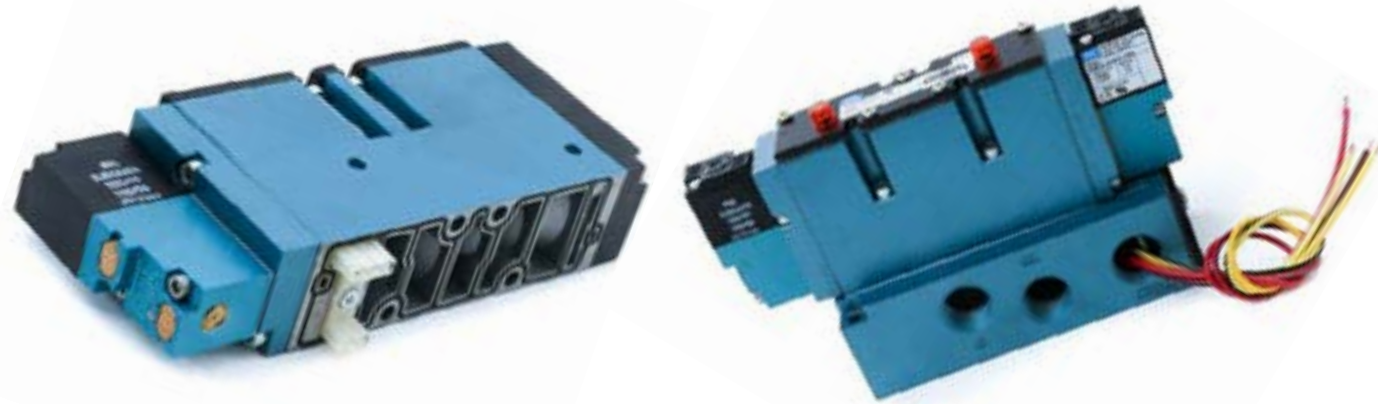

BRAND	PART #	DESCRIPTION	LINK	BRAND	PART #	DESCRIPTION	LINK
McNeilus	1108388* (1, 3)	Single Valve with Individual Base	-	McNeilus	1108381* (2, 3)	Double Solenoid, with Stand-Alone Base	link



BRAND	PART #	DESCRIPTION	LINK	BRAND	PART #	DESCRIPTION	LINK
McNeilus	1108379* (2, 3)	Double Valve with Base	link	McNeilus	1108389* (2, 3)	Double Solenoid, without Base	link

*
 (1) [1108385](#) Single Valve Seal Kit works with part numbers 1108380, 1108378, 1108388
 (2) [1108386](#) Double Valve Seal Kit works with part numbers 1108381, 1108379, 1108389
 (3) [1108387](#) Solenoid/ Pilot Valve works with part numbers 1108380, 1108378, 1108388, 1108381, 1108379, 1108389

AERATION COMPONENTS



BRAND	PART #	DESCRIPTION	LINK
McNeilus	1237069	Over Air Valve	link

[1237081](#) is the Repair Kit for 1237069

BRAND	PART #	DESCRIPTION	LINK
McNeilus	1237063	Over Air Valve	link

[1237082](#) is the Repair Kit for 1237063



BRAND	PART #	DESCRIPTION	LINK
McNeilus	1237071	Double Solenoid Over Air Valve	link

BRAND	PART #	DESCRIPTION	LINK
McNeilus	1237073	Double Solenoid Over Air Valve	link



BRAND	PART #	DESCRIPTION	LINK
McNeilus	1237099	Double Solenoid Over Air Valve	link

AERATION COMPONENTS



BRAND	PART #	DESCRIPTION	LINK
Liddell	900049010	Repair Kit for Single Solenoid Valves	link

BRAND	PART #	DESCRIPTION	LINK
Liddell	900050003	Single Solenoid Electric Over Air Valve	link



BRAND	PART #	DESCRIPTION	LINK
Con-E-Co	145764	.5in Quick Exhaust Valve for Air Cylinders	link

BRAND	PART #	DESCRIPTION	LINK
Con-E-Co	0201708	.5in Quick Exhaust Valve for Air Cylinders	link

BRAND	PART #	DESCRIPTION	LINK
McNeilus	26072452	Valve Without Base	link

AERATION COMPONENTS



BRAND	PART #	DESCRIPTION	LINK
WAM	VCP2731C	Safety Relief Valve	link

BRAND	PART #	DESCRIPTION	LINK
McNeilus	1237089	.5in Quick Exhaust Valve	link



BRAND	PART #	DESCRIPTION	LINK
McNeilus	1132737	Single Solenoid Electric Over Air Valve with Sub-Base	link

BRAND	PART #	DESCRIPTION	LINK
McNeilus	1132738	Electric Over Air Inching Valve with Sub-Base - Double Solenoid	link

AERATION COMPONENTS



BRAND	PART #	DESCRIPTION	LINK
McNeilus	400101602	1/4in Air Valve Exhaust Muffler	link
McNeilus	400106626	1/4in Adjustable Air Valve Exhaust Muffler	link
McNeilus	400101600	1/2in Air Valve Exhaust Muffler	link
McNeilus	1237093	1/2in Adjustable Air Valve Exhaust Muffler	link
McNeilus	400101601	3/4in Air Valve Exhaust Muffler	link
McNeilus	1237095	3/8in Air Valve Exhaust Muffler	link
McNeilus	1237091	1/8in Adjustable Air Valve Exhaust Muffler	link



BRAND	PART #	DESCRIPTION	LINK
McNeilus	26072461	Flow Control Valve	link

AERATION COMPONENTS



BRAND	PART #	DESCRIPTION	LINK	BRAND	PART #	DESCRIPTION	LINK
Rexcon	2120214601	3/8in Double Electric Over Air Valve	link	Rexcon	2120210801	1/2in Single Electric Over Air Valve	link
Rexcon	2120214701	3/8in Single Electric Over Air Valve	link	Rexcon	2120210901	1/2in Double Electric Over Air Valve	link

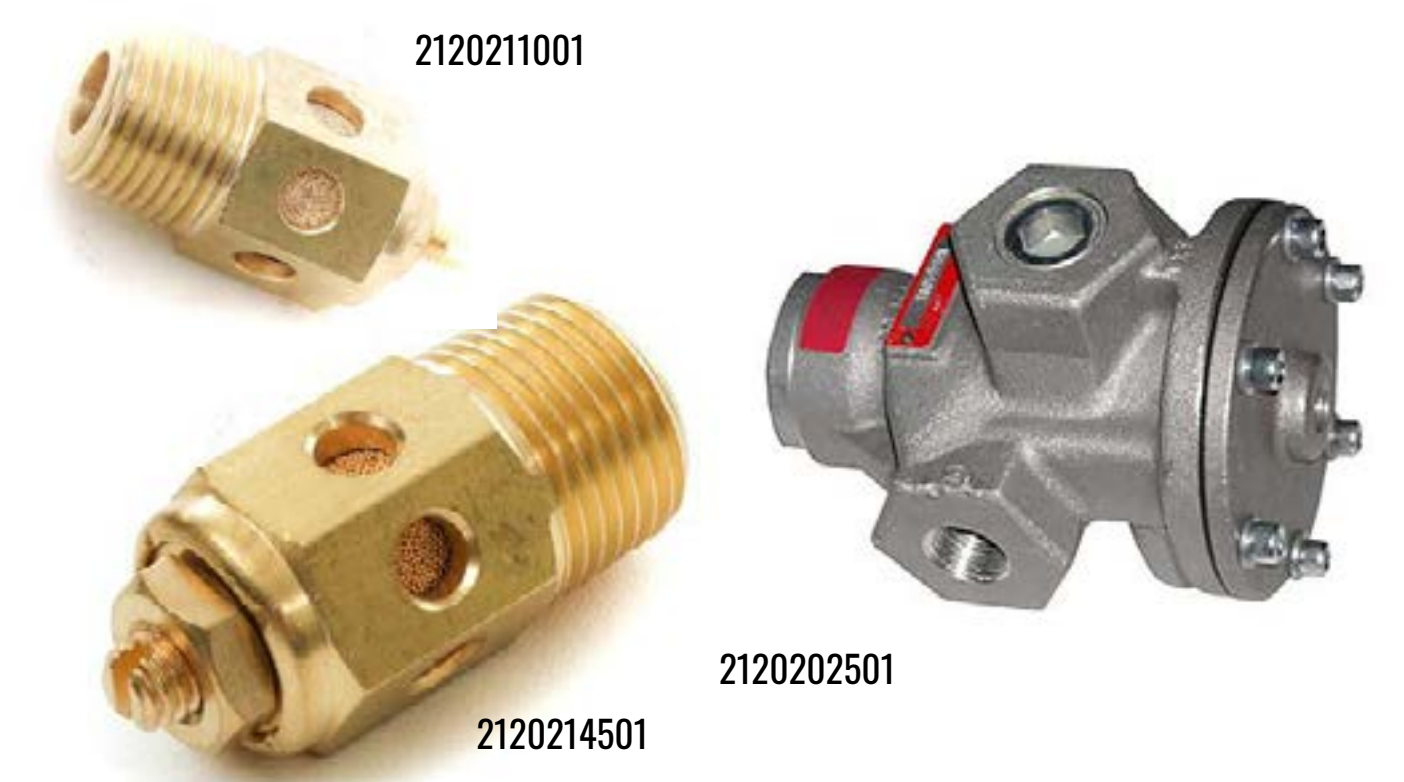

BRAND	PART #	DESCRIPTION	LINK	BRAND	PART #	DESCRIPTION	LINK
Rexcon	2120214501	3/8in Flow Control Muffler	link	Rexcon	2120202501	3/4in Poppet Valve	link
Rexcon	2120211001	1/2in Flow Control Muffler	link				

AERATION COMPONENTS

BRAND	PART #	DESCRIPTION	LINK
Terex	5576480	Two Position, Four-Way Single Solenoid Type (3/4in body family)	link
Johnson-Ross	1275001024	Two Position, Four-Way Single Solenoid Type (3/4in body family)	link
Terex	PS001424	Repair Kit	link
Terex	PS001423	Pilot Valve Coil Assembly	link



5576480



5576479

BRAND	PART #	DESCRIPTION	LINK
Terex	5576479	Inching Three Position, Four Way, Closed Center, Double Solenoid Type (3/4in body family)	link
Johnson-Ross	1275001025	Inching Three Position, Four Way, Closed Center, Double Solenoid Type (3/4in body family)	link
Terex	PS001425	Repair Kit	link
Terex	PS001109	Pilot Valve Coil Assembly	link

BRAND	PART #	DESCRIPTION	LINK
Terex	5576484	Manifold Type Sub-Base (stacking type), 1/2in NPT ports in end of manifold	link
Johnson-Ross	1275601027	Manifold Type Sub-Base (stacking type), 1/2in NPT ports in end of manifold	link



5576484

AERATION COMPONENTS

BRAND	PART #	DESCRIPTION	LINK
Terex	5576485	Sub-Base End Kit (for SMC Sub-Bases)	link
Johnson-Ross	1275601026	Sub-Base End Kit (for SMC Sub-Bases)	link



5576485

BRAND	PART #	DESCRIPTION	LINK
Terex	5576539	Three Position, Four-Way, Open Center, Double Solenoid Type (3/4in body family)	link

BRAND	PART #	DESCRIPTION	LINK
Terex	5577236	3/8in Two-Way Pilot Operated Directional Control Valve. Used for aeration and vibrator actuation	link
Johnson-Ross	1275001008	3/8in Two-Way Pilot Operated Directional Control Valve. Used for aeration and vibrator actuation	link
Terex	5577820	Repair Kit	link

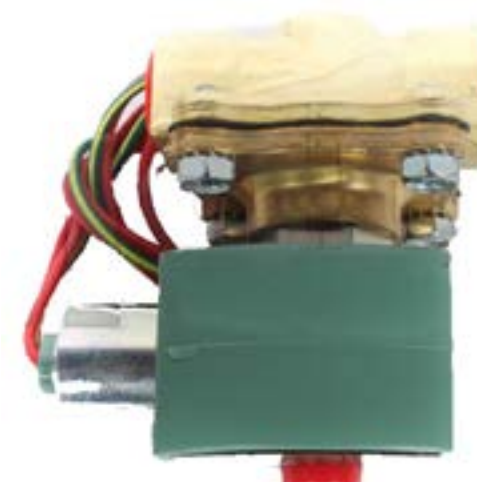

5577236



5576457

BRAND	PART #	DESCRIPTION	LINK
Terex	5576457	3/4in Two-Way Pilot Operated. Used for aeration and vibrator actuation	link

AERATION COMPONENTS



5576609



5577320

BRAND	PART #	DESCRIPTION	LINK
Terex	5577320	Single Station Sub-Base, .5in ports (stand alone, for L665 & L675 series valves)	-

BRAND	PART #	DESCRIPTION	LINK
Terex	5576609	1in 2-Way Pilot Operated Pulse-Jet Valve. Pilot controlled for 1, 3, & 6 CP, and 12, 16, 24, 32, and 40 CPV Central Dust Collectors	link
Johnson-Ross	1275000392	1in 2-Way Pilot Operated Pulse-Jet Valve. Pilot controlled for 1, 3, & 6 CP, and 12, 16, 24, 32, and 40 CPV Central Dust Collectors	link
Terex	5577823	Repair Kit for 5576609 & 1275000392	link



5576925

BRAND	PART #	DESCRIPTION	LINK
Terex	5576925	Four-Way, Two-Position Single Solenoid Type (1/8in body, 1/4in ports, NAMUR interface, for water butterfly actuators)	link
Johnson-Ross	1275000798	Four-Way, Two-Position Single Solenoid Type (1/8in body, 1/4in ports, NAMUR interface, for water butterfly actuators)	link

AERATION COMPONENTS

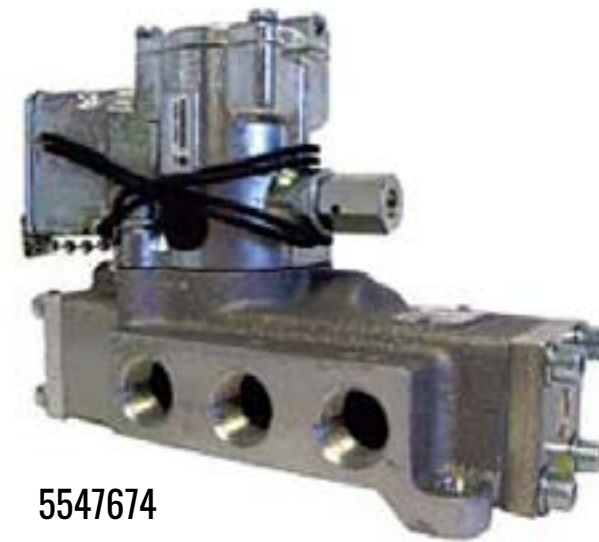

5547674



5573067

BRAND	PART #	DESCRIPTION	LINK
Terex	5547674	Two Position, Four-Way, Single Solenoid type with integral sub base (.5in ports) <i>Replaces L645-39-102</i>	link
Terex	5573067	Repair Kit for 5547674	link
Terex	5574143	Shock Pad for 5547674	link



5577319



5589747

BRAND	PART #	DESCRIPTION	LINK
Terex	5577319	Inching, Three Position, Four-way, Double solenoid Type with Integral sub-base (.5in ports)	link
Terex	5589747	Repair Kit for 5577319	link

AERATION COMPONENTS



BRAND	PART #	DESCRIPTION	LINK
Terex	5576767	Two Position, Four-way, Single Solenoid Type wuth separate sub-base (3/8in body family)	link
Terex	5573067	Repair Kit for 5576767	link
Terex	5574143	Shock Pad for 5576767	link



BRAND	PART #	DESCRIPTION	LINK
Terex	5576933	Inching, Three Position, Four-way, Double Solenoid Type with separate sub-base (3/8in body family)	link
Terex	5589747	Repair Kit for 5576767	link

AERATION COMPONENTS

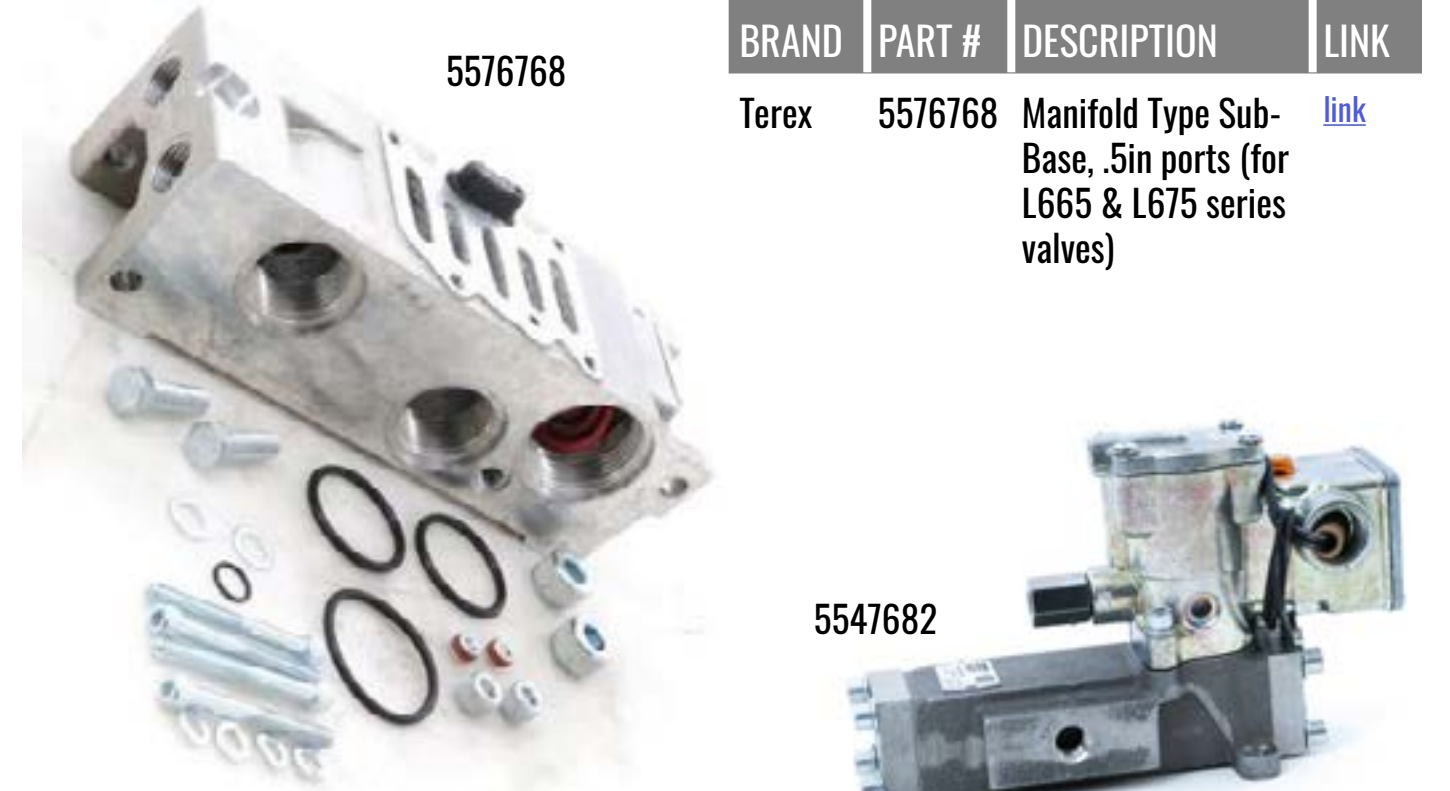

BRAND	PART #	DESCRIPTION	LINK
Terex	5576768	Manifold Type Sub-Base, .5in ports (for L665 & L675 series valves)	link

BRAND	PART #	DESCRIPTION	LINK
Terex	5547682	Two Position, Four-way, Single Solenoid Type with integral sub base (3/8in ports)	link
Terex	5547677	Repair Kit for 5547582	link



BRAND	PART #	DESCRIPTION	LINK
Terex	5576840	Two Position, Four-way, Single Solenoid Type with integral sub-base (3/8in ports)	link
Terex	5573067	Repair Kit for 5576840	link



BRAND	PART #	DESCRIPTION	LINK
Terex	5547707	Inching, Three Position, Four-way, Double Solenoid Type with Integral sub-base (3/8in ports)	link
Terex	5589747	Repair Kit for 5547707	link



SMC VALVES	DOUBLE SOLENOID (AGGREGATES)	SINGLE SOLENOID	AERATION/ VIBRATORS
Valve w/base	030384	031385	031386 031387
Valve Only	031380	031381	
	Replacement Coils		031960 (Coil) PME113DA 031964 (Coil) PME111DA

PAGE
INTENTIONALLY
LEFT BLANK

AERATION COMPONENTS

Common Air Cylinders								
	Part Number	Size(in) Bore X Stroke	Clevis	Clevis Pin	A	B	C	D
1	A127C4A	1.5in X 24	RC-05	P-05	31.250	0.5	0.5	55.250
2	A127BDA	2in X 18	RC-05	P-05	24.875	0.5	0.5	42.875
3	A127408	2.5in X 4	RC-05	P-05	11.375	0.5	0.5	15.375
4	A1285C3	2.5in X 6	RC-05	P-05	13.375	0.5	0.5	19.375
5	A12A313	2.5in X 7	RC-05	P-05	14.000	0.5	0.5	21.000
6	A1285BE	2.5in X 8	RC-05	P-05	15.375	0.5	0.5	23.375
7	A127602	2.5in X 12	RC-05	P-05	19.375	0.5	0.5	31.375
8	A127B43	2.5in X 18	RC-05	P-05	25.75	0.5	0.5	43.75
9	A12740A	3.25in X 8	RC-07	P-07	17.875	0.75	0.75	25.875
10	A127409	3.25 X 10	RC-07	P-07	19.875	0.75	0.75	29.875
11	A1285A8	3.25 X 10.5	RC-07	P-07	20.375	0.75	0.75	30.875
12	A1285C0	3.25 X 12	RC-07	P-07	21.875	0.75	0.75	33.875
13	A12765F	4in X 6	RC-07	P-07	15.250	0.75	0.75	21.250
14	A12740C	4in X 7	RC-07	P-07	16.250	0.75	0.75	23.250
15	A127AE6	4in X 8	RC-07	P-07	17.875	0.75	0.75	25.875
16	A1280F6	4in X 9	RC-07	P-07	18.875	0.75	0.75	27.875
17	A12753C	4in X 10	RC-07	P-07	19.250	0.75	0.75	29.250
18	A1282FB	4in X 11	RC-07	P-07	20.875	0.75	0.75	31.875
19	A127B38	4in X 12	RC-07	P-07	21.875	0.75	0.75	33.875
20	A127478	4in X 13	RC-07	P-07	22.250	0.75	0.75	35.250
21	A1286D4	4in X 14	RC-07	P-07	23.875	0.75	0.75	37.875
22	A128D68	4in X 15	RC-07	P-07	28.125	0.75	0.75	43.125
23	A12B4C3	4in X 18	RC-07	P-07	27.875	0.75	0.75	45.875
24	A128645	5in X 8	RC-07	P-07	18.125	0.75	0.75	26.125
25	A12A8B4	5in X 10	RC-07	P-07	20.125	0.75	0.75	30.125
26	A1283E3	5in X 11	RC-07	P-07	21.125	0.75	0.75	32.125

AERATION COMPONENTS

Common Air Cylinders Continued								
	E	F	G	H	Rod Diameter	Clevis*	Port Size N.P.T.	Seal Kit
1		X	X		0.625in	P2	3/8in	A12AF45
2		X	X		0.625in	P1	3/8in	A12AF46
3		X	X		0.625in	P2	3/8in	A12AF44
4		X	X		0.625in	P2	3/8in	A12AF44
5		X	X		0.625in	P1	3/8in	A12AF44
6		X	X		0.625in	P2	3/8in	A12AF44
7		X	X		0.625in	P2	3/8in	A12AF44
8		X	X		0.625in	P2	3/8in	A12AF44
9		X	X		1.000in	P2	1/2in	A12AC11
10		X	X		1.000in	P2	1/2in	A12AC11
11		X	X		1.000in	P2	1/2in	A12AC11
12		X	X		1.000in	P2	1/2in	A12AC11
13		X	X		1.000in	P1	1/2in	A128CA5
14		X	X		1.000in	P1	1/2in	A128CA5
15		X	X		1.000in	P2	1/2in	A128CA5
16		X	X		1.000in	P2	1/2in	A128CA5
17		X	X		1.000in	P1	1/2in	A128CA5
18		X	X		1.000in	P2	1/2in	A128CA5
19		X	X		1.000in	P2	1/2in	A128CA5
20		X	X		1.000in	P1	1/2in	A128CA5
21		X	X		1.000in	P2	1/2in	A128CA5
22		X	X		1.000in	P2	1/2in	A128CA5
23		X	X		1.000in	P2	1/2in	A128CA5
24		X	X		1.000in	P2	1/2in	A1254A3
25		X	X		1.000in	P2	1/2in	A1254A3
26		X	X		1.000in	P2	1/2in	A1254A3

*Detachable Clevis Type P1 = Short, P2 = Standard

AERATION COMPONENTS

Common Air Cylinders

	Part Number	Size(in)/BoreXStroke	Clevis	Clevis Pin	A	B	C	D
27	A1285FC	5in X 12	RC-07	P-07	22.125	0.75	0.75	34.125
28	A129AB6	5in X 14	RC-07	P-07	24.125	0.75	0.75	38.125

Stephens Air Cylinders

Description	Part Number
2.5in x 4in Air Cylinders	ST3P225X4SP5300
2.5in x 6in Air Cylinders	ST3P225X6SP5300
2.5in x 8in Air Cylinders	ST3P225X8SP5300
2.5in x 12in Air Cylinders	ST3P225X12SP5300
2.5in x 18in Air Cylinders	ST3P225X18SP5300
3.25in x 8in Air Cylinders	ST3P2325X8SP5300
3.25in x 10in Air Cylinders	ST3P2325X10SP5300
3.25in x 12in Air Cylinders	ST3P2325X12SP5300
4in x 8in Air Cylinders	ST3P24X8SP5300
4in x 10in Air Cylinders	ST3P24X10SP5300
4in x 11in Air Cylinders	ST3P24X11SP5300
4in x 12in Air Cylinders	ST3P24X12SP5300
4in x 14in Air Cylinders	ST3P24X14SP5300
5in x 8in Air Cylinders	ST3P25X8SP5300
5in x 10in Air Cylinders	ST3P25X10SP5300
5in x 12in Air Cylinders	ST3P25X12SP5300
Air Cylinder Rod Stop 1in ID x 1in Thick	A48A501X1
Air Cylinder Rod Stop 1.25in ID x 1.5in Thick	A48A50

AERATION COMPONENTS

Common Air Cylinders Continued

	E	F	G	H	Rod Diameter	Clevis*	Port Size N.P.T.	Seal Kit
27		X	X		1.000in	P2	1/2in	A1254A3
28		X	X		1.000in	P2	1/2in	A1254A3

*Detachable Clevis Type P1 = Short, P2 = Standard

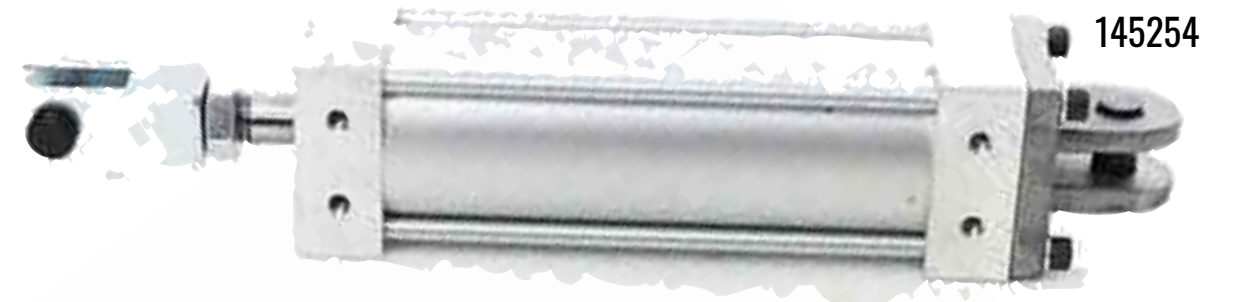

BRAND	PART #	DESCRIPTION	LINK
Con-E-Co	145254	2.5in x 6in Air Cylinder with Clevis and Pins	link



BRAND	PART #	DESCRIPTION	LINK
Con-E-Co	1375072	3in x 8in Air Cylinder with Clevis and Pins	link
Con-E-Co	145252	3in x 8in Air Cylinder with Heavy Duty Mounts	link
Con-E-Co	145507	3in Air Cylinder Repair Kit	link

MPPARTS CYLINDER ORDER SHEET

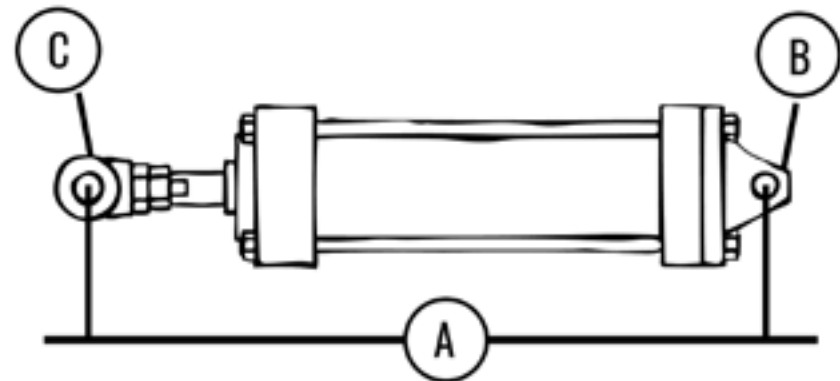

A: Cylinder Closed Length
(Center-to-Center of Pin Holes)

A: _____

B: Mounting Pin Diameter (Dead End)

B: _____

C: Mounting Pin Diameter (Live End)

C: _____

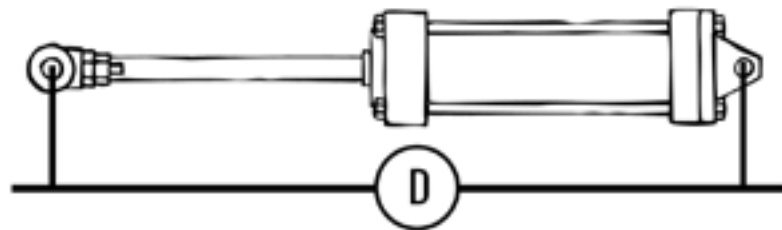

D: Cylinder Open Length
(Center-to-Center of Pin Holes)

D: _____

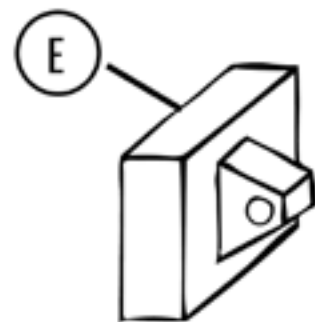

E: Single Eye Mounting

E: _____

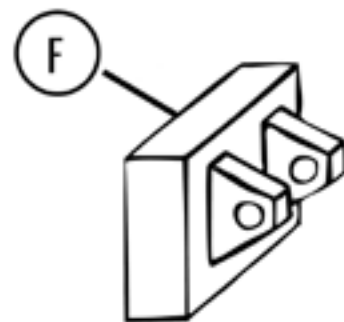

F: Double Eye Mounting

F: _____

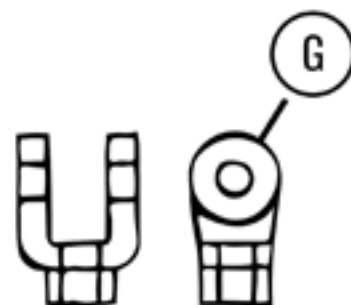

G: Rod Clevis Style

G: _____

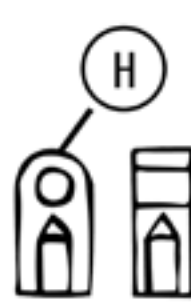

H: Rod Eye Style

H: _____



BRAND	PART #	DESCRIPTION	LINK
Con-E-Co	145298	3in x 8in Air Cylinder with Clevis and Pins	link
Con-E-Co	145297	3in x 8in Air Cylinder with Heavy Duty Mounts	link
Con-E-Co	145257	3.5in x 8in Air Cylinder with Heavy Dury Mounts	link
Con-E-Co	145253	2.5in x 16in Air Cylinder with Heavy Duty Mounts	link
Con-E-Co	145264	3.5in x 24 Air Cylinder with Heavy Duty Mountd	link
Con-E-Co	145508	3.5in Air Cylinder Repair Kit	link

AERATION COMPONENTS

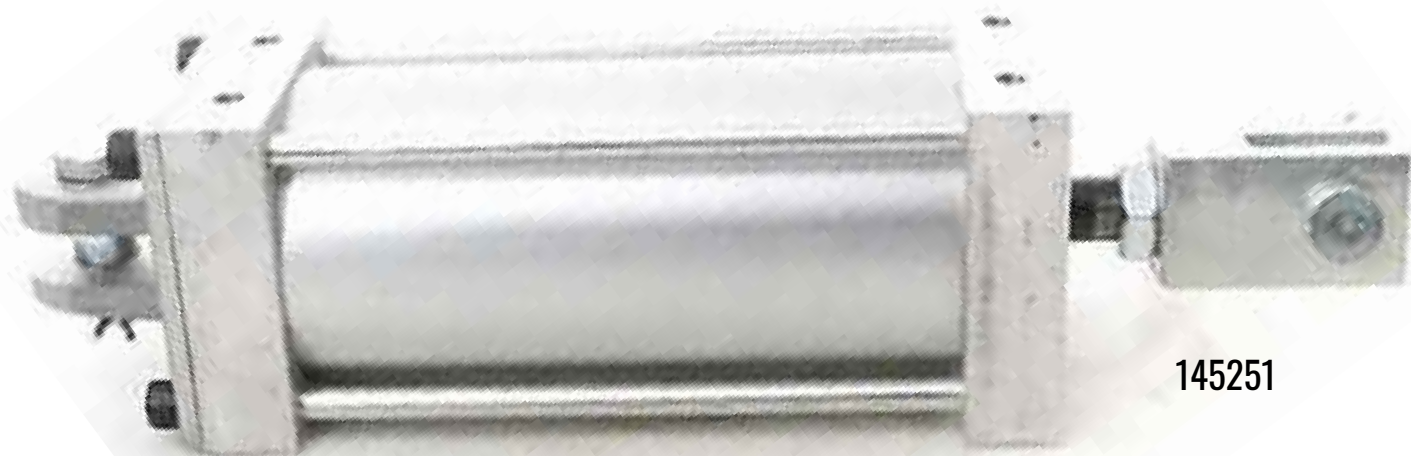

145251

BRAND	PART #	DESCRIPTION	LINK
Con-E-Co	145287	I450 8in Air Cylinder with Standard Mounts	link
Con-E-Co	145288	I450 10in Air Cylinder with Standard Mounts	link
Con-E-Co	145251	I450 8in Air Cylinder with Heavy-Duty Mounts	link
Con-E-Co	145250	I450 10in Air Cylinder with Heavy-Duty Mounts	link
Con-E-Co	145256	I450 12in Air Cylinder with Heavy-Duty Mounts	link
Con-E-Co	145509	I450 Repair Kit	link

BRAND	PART #	DESCRIPTION	LINK
Con-E-Co	0234396	2.5in x 12in Air Cylinder for Telescopic Boot	link

0115285



BRAND	PART #	DESCRIPTION	LINK
Con-E-Co	0115285	Air Cylinder Clevis and Pin	link

AERATION COMPONENTS



1375074

BRAND	PART #	DESCRIPTION	LINK
Con-E-Co	145410	I250 4in Air Cylinder with Standard Mounts	link
Con-E-Co	145411	I250 6in Air Cylinder with Standard Mounts	link
Con-E-Co	1375074	I300 8in Air Cylinder with Standard Mounts	link
Con-E-Co	1375076	I300 8in Air Cylinder with Heavy-Duty Mounts	link
Con-E-Co	1375075	I350 8in Air Cylinder with Standard Mounts	link
Con-E-Co	145306	I350 16in Air Cylinder with Heavy Duty Mounts	link
Con-E-Co	145145	I450 8in Air Cylinder with Standard Mounts	link
Con-E-Co	145137	I450 8in Air Cylinder with Heavy Duty Mounts	link
Con-E-Co	145307	I450 10in Air Cylinder with Heavy Duty Mounts	link
Con-E-Co	145146	I450 12in Air Cylinder with Heavy Duty Mounts	link

AERATION COMPONENTS

0072466



BRAND	PART #	DESCRIPTION	LINK
Con-E-Co	0072466	4in x 9in Cylinder	link
Con-E-Co	0101680	5in x 11in Cylinder without Internal Cushion	link
Con-E-Co	0140039	5in x 11in Cylinder with Internal Cushion	link
Con-E-Co	0101681	5in x 11in CSI Cylinder Repair Kit (Pre 1995)	link



65776

BRAND	PART #	DESCRIPTION	LINK
Erie Strayer	65770	5in x 11in Air Cylinder	link
Erie Strayer	61845	5in x 11in Air Cylinder with Clevis and Pins	link
Erie Strayer	65769	4in x 11in Air Cylinder with Clevis and Pins	link
Erie Strayer	65776	5in x 13in Air Cylinder	link

AERATION COMPONENTS

BRAND	PART #	DESCRIPTION	LINK
Liddell	900109025	2.5in x 15in Air Cylinder	link
Liddell	900109328	3.25in x 8in Air Cylinder	link
Liddell	900109030	3.25in x 10in Air Cylinder	link
Liddell	900109003	4in x 10in Air Cylinder	link
Liddell	900109023	4in x 11in Air Cylinder with Clevis and Pins	link
Liddell	900109037	4in x 12in Air Cylinder with Clevis and Pins	link
Liddell	900109012	4in x 12in Air Cylinder	link
Liddell	900109031	4in x 14in Air Cylinder	link
Liddell	900109015	4in Air Cylinder Seal Repair Kit	link
Liddell	900109006MP	5in x 10in Air Cylinder with Magnetic Piston	link
Liddell	900109038	5in x 11in Air Cylinder with Clevis and Pins	link
Liddell	900109014	5in x 11in Air Cylinder	link
Liddell	900109008MP	5in x 14in Air Cylinder with Magnetic Piston	link
Liddell	900109016	5in Air Cylinder Seal Repair Kit	link
Liddell	900109498	7/8-14 Rod Clevis	link
Liddell	900109502	.75-16 Rod Clevis	link
Liddell	900109503	1-14 Rod Clevis	link
Liddell	900109509	.75in Rod Clevis Pin	link
Liddell	900109510	1.0 Rod Clevis Pin	link

AERATION COMPONENTS



20072466

BRAND	PART #	DESCRIPTION	LINK
McNeilus	20072466	4in x 9in Air Cylinder with Clevis and Pins	link
McNeilus	740101680	5in x 11in Air Cylinder with Clevis and Pins	link
McNeilus	740101681	5in x 11in Air Cylinder Seal Kit CSI Pre 1995	link



200117050

BRAND	PART #	DESCRIPTION	LINK
McNeilus	200117050	2in x 18in Air Cylinder for Telescopic Boot	link
McNeilus	740234396	2.5in x 12in Air Cylinder for Telescopic Boot	link

BRAND	PART #	DESCRIPTION	LINK
McNeilus	740115285	5in Clevis and Pin	link

BRAND	PART #	DESCRIPTION	LINK
McNeilus	1237059	2.5in Air Cylinder Repair Kit	link



740115285

AERATION COMPONENTS

BRAND	PART #	DESCRIPTION	LINK
McNeilus	1237057	700 Air Cylinder Repair Kit	link

1237057



BRAND	PART #	DESCRIPTION	LINK
McNeilus	1237056	960 Air Cylinder Repair Kit	link

1237056



BRAND	PART #	DESCRIPTION	LINK
McNeilus	1237056	960 Air Cylinder Repair Kit	link

BRAND	PART #	DESCRIPTION	LINK
McNeilus	1237010	4.5in x 8in Air Cylinder with Clevis and Pins	link



1237010

BRAND	PART #	DESCRIPTION	LINK
McNeilus	1237037	2.5in x 6in Air Cylinder with Clevis and Pins	link

1237037

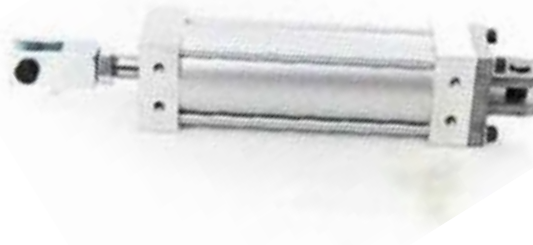

BRAND	PART #	DESCRIPTION	LINK
McNeilus	1237037	2.5in x 6in Air Cylinder with Clevis and Pins	link

BRAND	PART #	DESCRIPTION	LINK
McNeilus	1237039	3.5in x 8in Air Cylinder with Heavy Duty Mounts	link

McNeilus	1237067	Repair Kit for 1237039	link
----------	---------	------------------------	----------------------



1237067

AERATION COMPONENTS



1237036



1237066

BRAND	PART #	DESCRIPTION	LINK
McNeilus	1237036	3in x 8in Air Cylinder with Heavy Duty Mounts	link
McNeilus	1237066	3in Air Cylinder Repair Kit	link



1237035

BRAND	PART #	DESCRIPTION	LINK
McNeilus	1237035	4.5in x 8in Air Cylinder with Heavy Duty Mounts	link
McNeilus	1237034	4.5in x 10in Air Cylinder with Heavy Duty Mounts	link
McNeilus	1237038	4.5in x 12in Air Cylinder with Heavy Duty Mounts	link
McNeilus	1237068	4.5in Air Cylinder Repair Kit	link

AERATION COMPONENTS

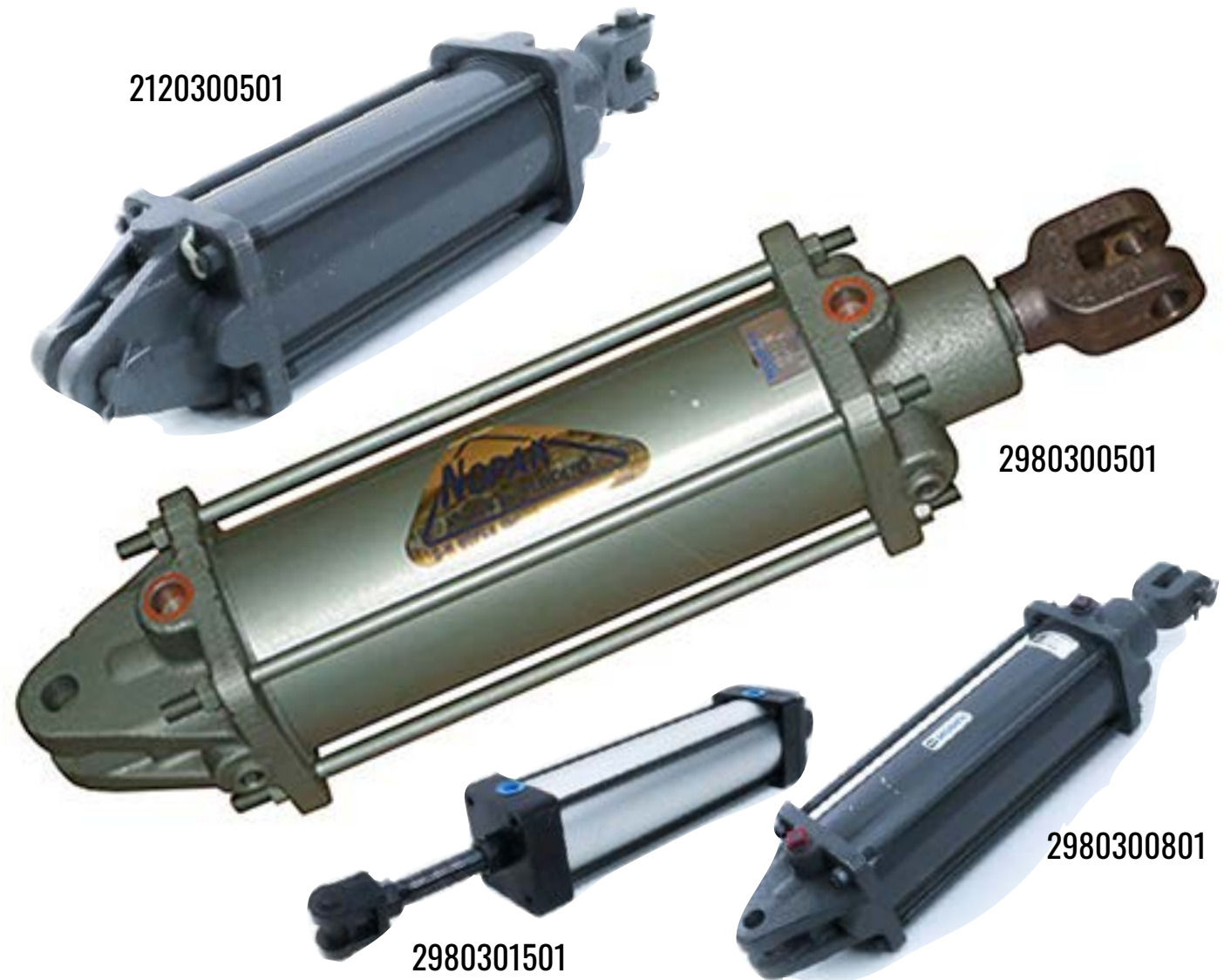

2120300501

2980300501

2980301501

2980300801

BRAND	PART #	DESCRIPTION	LINK
RexCon	2120301601	2.5in x 6in Air Cylinder with Clevis and Pins	link
RexCon	2120300901	2.5in x 18in Air Cylinder with Clevis and Pins	link
RexCon	2120303101	2.5in x 22in Air Cylinder with Clevis and Pins	link
RexCon	2980300501	3in x 10in Air Cylinder with Clevis and Pins	link
RexCon	2120300501	4in x 8in Air Cylinder with Clevis and Pins	link
RexCon	2980300801	4in x 10in Air Cylinder with Clevis and Pins	link
RexCon	2980301501	4in x 10in Air Cylinder with Clevis and Pins	link

AERATION COMPONENTS

BRAND	PART #	DESCRIPTION	LINK
Johnson-Ross	55600720613	4.5in x 8in Trunnion Mount Air Cylinder	link
Johnson-Ross	55600720626	5in x 15in Trunnion Mount Air Cylinder	link



BRAND	PART #	DESCRIPTION	LINK
Johnson-Ross	5578761	4.5in x 8in Air Cylinder with Clevis and Pins	link
Johnson-Ross	5576732	4in x 8in Air Cylinder with Clevis and Pins	link
Johnson-Ross	5576890	Seal Kit for 4in Bore x 1in Rod Air Cylinder	link

BRAND	PART #	DESCRIPTION	LINK
WAM	CPL080150	Slide Gate Air Cylinder	link
WAM	CPL080200	Slide Gate Air Cylinder	link
WAM	CPL080250	Slide Gate Air Cylinder	link
WAM	CPL080300	Slide Gate Air Cylinder	link
WAM	RG13830005	Slide Gate Air Cylinder Repair Kit	link

AERATION COMPONENTS



BRAND	PART #	DESCRIPTION	LINK
Vince Hagan	022111	2.5in x 6in Air Cylinder with Clevis and .625in Pins	link
Vince Hagan	023733	2.5in x 8in Air Cylinder with Clevis and Pins	link
Vince Hagan	022574	3.25in x 10in Air Cylinder with Clevis and Pins	link
Vince Hagan	023735	3.25in x 12in Air Cylinder with Clevis and Pins	link
Vince Hagan	023737	4in x 4in / 4in x 6in Air Cylinder with Standard Clevis Mounts	link
Vince Hagan	020461	4in x 10in Air Cylinder with Clevis and Pins	link



AERATION COMPONENTS

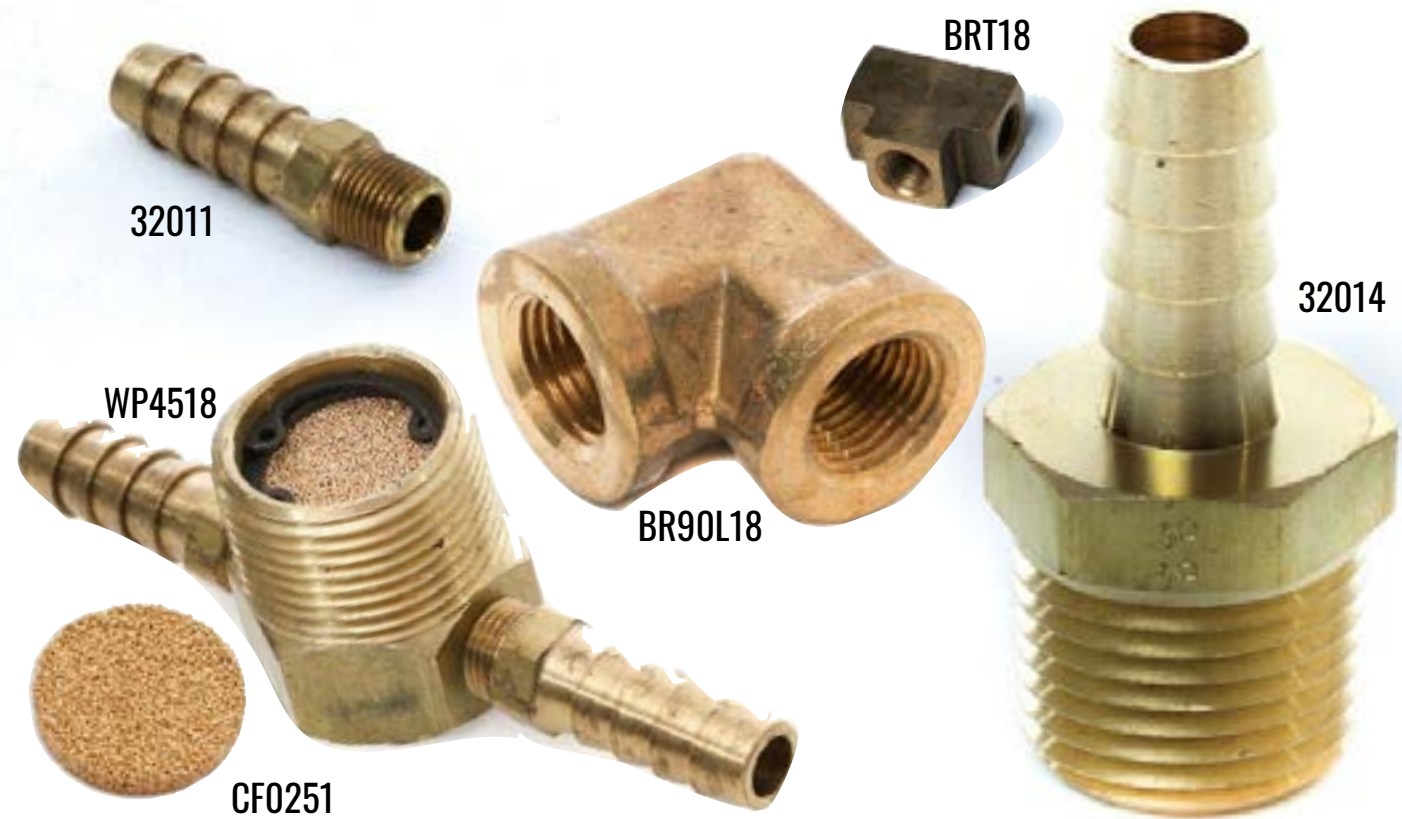

BRAND	PART #	DESCRIPTION	LINK
Stephens	32011	Brass .375 Hose Barb x .125 Male Pipe Fitting	link
Stephens	32014	Brass .375 Hose Barb x .50 Male Pipe Fitting	link
Stephens	BRT18	Brass Fitting	link
Stephens	FCP8L	.5in Bimba Flow Control Valve	link
Stephens	BR90L18	Brass Fitting	link
Stephens	WP4518	.75in Aeration Tee	link
Stephens	CF0251	.75in Plant Aeration Nozzle Screen	link
Stephens	WP4519	.75in Plant Aeration Elbow 90/C	link
Stephens	6912	.75in Aeration Nozzle Snap Ring	link
Stephens	AIRHOSE38RED	.375in Red Plant Air Line Hose	link
Stephens	AIRHOSE12RED	.5in Red Plant Air Line Hose	link

AERATION COMPONENTS

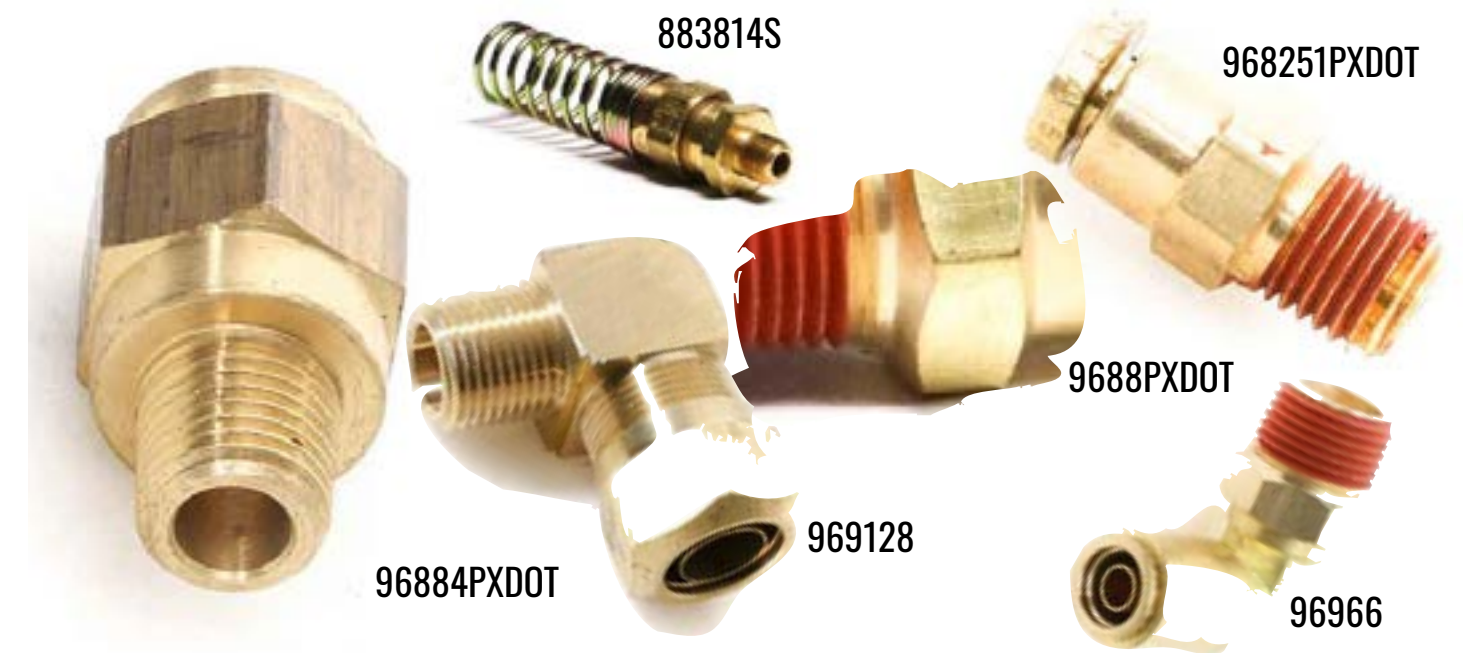

BRAND	PART #	DESCRIPTION	LINK
CMI Roadbuilding	96884PXDOT	.5in Tube x .25in MPT Brass Push Connect DOT Connector	link
CMI Roadbuilding	883814S	3/8in Hose x .25in MPT Brass DOT Compression Coupler	link
CMI Roadbuilding	881238S	.5in Hose x 3/8in MPT Brass DOT Compression Coupler	link
CMI Roadbuilding	883812S	3/8in Hose x .5in MPT Brass DOT Compression Coupler	link
CMI Roadbuilding	883838S	3/8in Hose x 3/8in in MPT Brass Compression Coupler	link
CMI Roadbuilding	968251PXDOT	Brass Fitting	link
CMI Roadbuilding	9688PXDOT	.5in Tube x 3/8in MPT Brass DOT Connector Push Connect	link
CMI Roadbuilding	96888	.5in Tube x .5in MPT Brass DOT Connector Compression	link
CMI Roadbuilding	969128	.75in Tube x .5in MPT Brass DOT 90° Elbow Compression	link
CMI Roadbuilding	96962	3/8in Tube x 1/8in MPT Brass 90° Elbow Compression	link
CMI Roadbuilding	96966	3/8in Tube x 3/8in MPT Brass 90° Elbow Compression	link
CMI Roadbuilding	96988	.5in Tube x .5in MPT Brass DOT 90° Elbow Compression	link
CMI Roadbuilding	9624	.25in Brass DOT Union Coupling Compression Tube	link

AERATION COMPONENTS



BRAND	PART #	DESCRIPTION	LINK
CMI Roadbuilding	9604	.25in Brass DOT Sleeve Compression Tube	link
CMI Roadbuilding	96010	5/8in Brass DOT Sleeve Compression Tube	link
CMI Roadbuilding	96012	.75in Brass DOT Sleeve Compression Tube	link
CMI Roadbuilding	9606	3/8in Brass DOT Sleeve Compression Tube	link
CMI Roadbuilding	9608	.5in Brass DOT Sleeve Compression Tube	link
CMI Roadbuilding	98410	5/8in Brass DOT Sleeve Compression Tube	link
CMI Roadbuilding	98412	.75in Brass DOT Sleeve Compression Tube	link
CMI Roadbuilding	9844	.25in Brass DOT Insert Compression Tube	link
CMI Roadbuilding	9846	3/8in Brass DOT Insert Compression Tube	link
CMI Roadbuilding	9848	.5in Brass DOT Insert Compression Tube	link

AERATION COMPONENTS



BRAND	PART #	DESCRIPTION	LINK
Con-E-Co	140062	.5in Hose x .5in NPT Brass P-T-C-Male 90° Swivel Elbow	link

BRAND	PART #	DESCRIPTION	LINK
Johnson-Ross	5576470	.5in Tube x .5in MPT Brass Push Connect Connector	link
Johnson-Ross	5576471	Brass Bush Connect DOT Connector Push Connect	link
Johnson-Ross	5576472	3/8in Tube x .25in MPT Brass Push Connect Connector	link
Johnson-Ross	5576467	.75in x .75in Brass NPT Compression Fitting	link
Johnson-Ross	5577047	Brass DOT Connector Push Connect	link
Johnson-Ross	5577048	.5in Tube x 3/8in MPT Brass Push Connect Connector	link
Johnson-Ross	5576581	Composite DOT 90° Elbow Push Connect	link

MPPARTS	A15C830	.75in Black DOT Tubing	link
MPPARTS	A1275A8	3/8in Black DOT Tubing	link
MPPARTS	A124C5D	.5in Black DOT Tubing	link
MPPARTS	A125171	5/8in Black DOT Tubing	link

BELT WIPERS



WP1022600202

BRAND	PART #	DESCRIPTION	LINK
Stephens	WP1022600202	30in Red Wiper Blade	link
Stephens	WP1022600302	36in Red Wiper Blade	link
Stephens	PT1T38Q	Wiper Blade Safety Snap Pin	link



1222742

BRAND	PART #	DESCRIPTION	LINK
Con-E-Co	1222742	22in Long Urethane Belt Cleaner	link



1228743

BRAND	PART #	DESCRIPTION	LINK
Con-E-Co	1228743	28in Long Urethane Belt Cleaner	link

BELT WIPERS

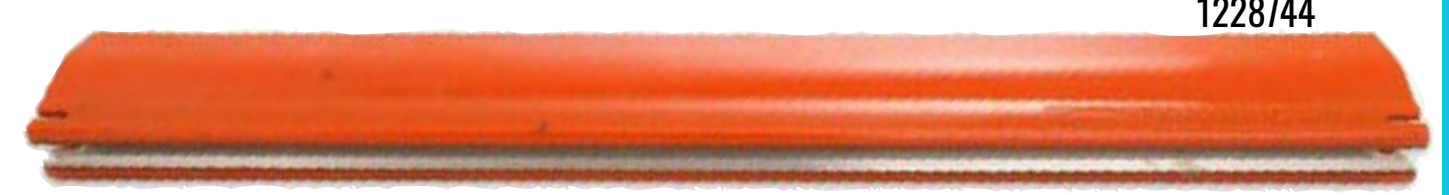

1228744

BRAND	PART #	DESCRIPTION	LINK
Con-E-Co	1228744	34in Long Urethane Belt Cleaner	link

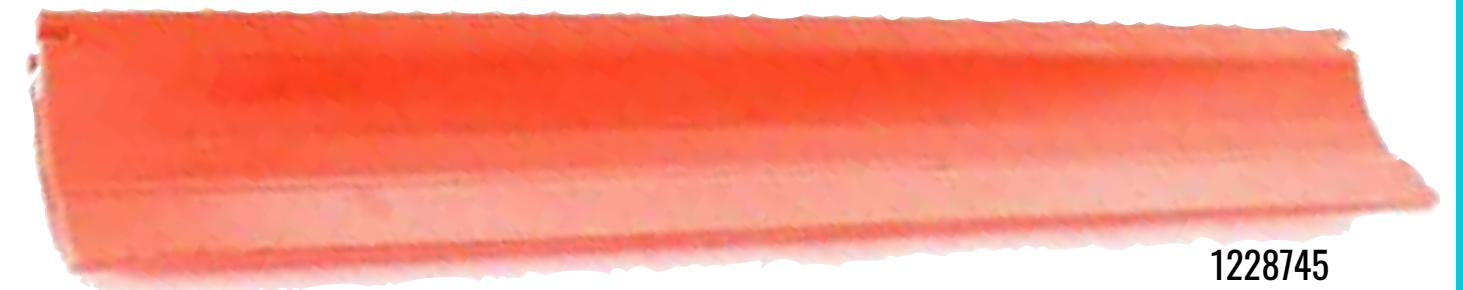

1228745

BRAND	PART #	DESCRIPTION	LINK
Con-E-Co	1228745	40in Long Urethane Belt Cleaner	link



1228746

BRAND	PART #	DESCRIPTION	LINK
Con-E-Co	1228746	46in Long Urethane Belt Cleaner	link

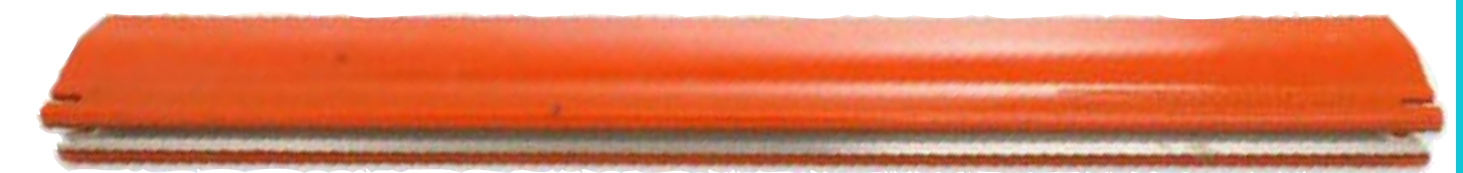

0700544

BRAND	PART #	DESCRIPTION	LINK
Superior	0700544	34in Primary Urethane Belt Scraper Wiper Blade	link

BELT WIPERS

1408480

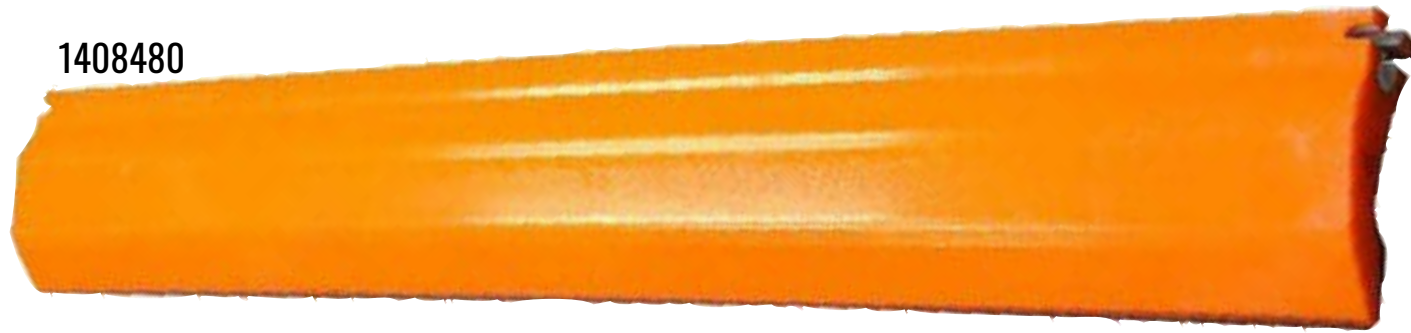

BRAND	PART #	DESCRIPTION	LINK
-------	--------	-------------	------

Con-E-Co	1408480	52in Primary Urethane Belt Scraper Wiper Blade	link
----------	---------	--	----------------------

Con-E-Co	1421990	Tension Wiper Assembly	link
----------	---------	------------------------	----------------------

Con-E-Co	0116923	30in Belt Wiper	link
----------	---------	-----------------	----------------------

0700542



BRAND	PART #	DESCRIPTION	LINK
-------	--------	-------------	------

Superior	0700542	22in Primary Urethane Belt Scraper Wiper Blade	link
----------	---------	--	----------------------

0700543



BRAND	PART #	DESCRIPTION	LINK
-------	--------	-------------	------

Superior	0700543	22in Primary Urethane Belt Scraper Wiper Blade	link
----------	---------	--	----------------------

BELT WIPERS



0700545

BRAND	PART #	DESCRIPTION	LINK
-------	--------	-------------	------

Superior	0700545	40in Primary Urethane Belt Scraper Wiper Blade	link
----------	---------	--	----------------------



0700546

BRAND	PART #	DESCRIPTION	LINK
-------	--------	-------------	------

Superior	0700546	46in Primary Urethane Belt Scraper Wiper Blade	link
----------	---------	--	----------------------

0700547

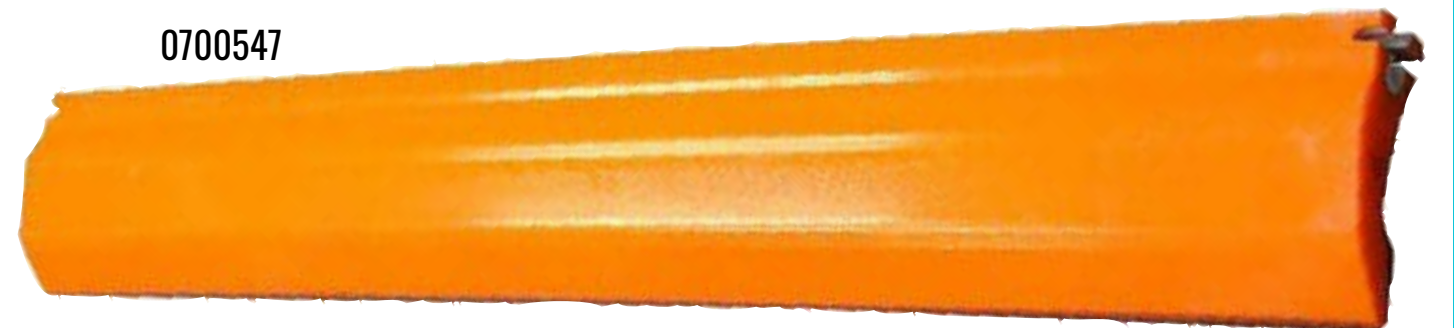

BRAND	PART #	DESCRIPTION	LINK
-------	--------	-------------	------

Superior	0700547	52in Primary Urethane Belt Scraper Wiper Blade	link
----------	---------	--	----------------------

BELT WIPERS



0700549

BRAND	PART #	DESCRIPTION	LINK
Superior	0700549	58in Primary Urethane Belt Scraper Wiper Blade	link



P2420541

BRAND	PART #	DESCRIPTION	LINK
Superior	P2420541	Primary Belt Cleaner Scraper Wiper Assembly for 24in Belt Widths	link



P302601

BRAND	PART #	DESCRIPTION	LINK
Superior	P3020601	58in Primary Urethane Belt Scraper Wiper Blade	link



P3620661

BRAND	PART #	DESCRIPTION	LINK
Superior	P3620661	Primary Belt Cleaner Scraper Wiper Assembly for 36in Belt Widths	link



P5420842

BRAND	PART #	DESCRIPTION	LINK
Superior	P5420842	54in Belt Cleaner	link

BELT WIPERS



P7221022

BRAND	PART #	DESCRIPTION	LINK
Superior	P7221022	Primary Belt Cleaner Scraper Wiper Assembly for 72in Belt Widths	link

BRAND	PART #	DESCRIPTION	LINK
Superior	P2480541	Primary Belt Cleaner Scraper Wiper Assembly for 24in Belt Widths	link



P2480541



P3080601

BRAND	PART #	DESCRIPTION	LINK
Superior	P3080601	Primary Belt Cleaner Scraper Wiper Assembly for 24in Belt Widths	link

BRAND	PART #	DESCRIPTION	LINK
Superior	P3680661	Primary Belt Cleaner Scraper Wiper Assembly for 36in Belt Widths	link



P3680661



P4280721

BRAND	PART #	DESCRIPTION	LINK
Superior	P4280721	Primary Belt Cleaner Scraper Wiper Assembly for 42in Belt Widths	link

BELT WIPERS AND COMPONENTS



32000188

BRAND	PART #	DESCRIPTION	LINK
Superior	32000188	Primary Exterra Belt Cleaner Field Fit Mounting Bracket	link



242202PLY

Superior	1300975	Wiper Blade Safety Snap Pin	link
Superior	32000097	Belt Scraper Bracket Tensioner Assembly	link



302202PLY

BRAND	PART #	DESCRIPTION	LINK
Stephens	242202PLY	24in Conveyor Belt 2 PLY 220 3/16in X 1/16in	link
OTHER SIZES AVAILABLE			

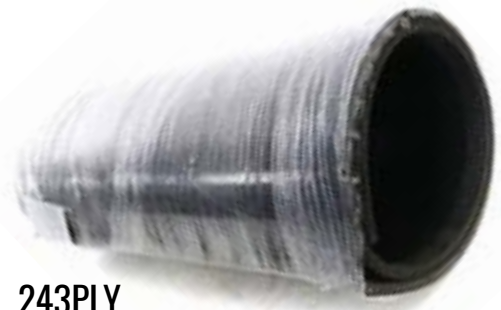

243PLY

BRAND	PART #	DESCRIPTION	LINK
Stephens	302202PLY	30in Conveyor Belt 2 PLY 220 3/16in X 1/16in	link
OTHER SIZES AVAILABLE			



303PLY

BRAND	PART #	DESCRIPTION	LINK
Stephens	243PLY	24in Conveyor Belt 3 PLY 330 3/16in X 1/16in	link
OTHER SIZES AVAILABLE			

BRAND	PART #	DESCRIPTION	LINK
Stephens	303PLY	30in Conveyor Belt 3 PLY 330 3/16in X 1/16in	link
OTHER SIZES AVAILABLE			

BRAND	PART #	DESCRIPTION	LINK
Stephens	SB8X24	Conveyor Skirtboard Rubber 1/2in Thick x 24in Wide	link
OTHER SIZES AVAILABLE			

BELTING COMPONENTS



HP1

BRAND	PART #	DESCRIPTION	LINK
Stephens	HP1	Flexco® Conveyor Belt Fastener Power Punch Tool	link



B1B

BRAND	PART #	DESCRIPTION	LINK
Stephens	B1B	Flexco® Hand Boring Bit	link



110

BRAND	PART #	DESCRIPTION	LINK
Stephens	110	Flexco® Bolt Breaker	link



14030

BRAND	PART #	DESCRIPTION	LINK
Stephens	14030	Flexco® Template	link



S1S

BRAND	PART #	DESCRIPTION	LINK
Stephens	S1S	Flexco® Hand Wrench	link



H100

BRAND	PART #	DESCRIPTION	LINK
Stephens	H100	Flexco® Power Wrench	link



190C

BRAND	PART #	DESCRIPTION	LINK
Stephens	190C	Flexco® Fasteners Sets	link



19030

BRAND	PART #	DESCRIPTION	LINK
Stephens	19030	Flexco® Template for 30in Belt	link



30803

BRAND	PART #	DESCRIPTION	LINK
Stephens	30803	Flexco® Curved Template for 24in Belt	link

BRAND	PART #	DESCRIPTION	LINK
Stephens	FASTNERS140E	Flexco® 25 Count Belt Fasteners	link

Stephens	375XJ24	Flexco® Bolt Hinged Fastening System for 24in Belts	link
----------	---------	---	----------------------

BELTING COMPONENTS



CONVEYOR BELTING SOLD BY FOOT

BRAND	PART #	DESCRIPTION	LINK
Con-E-Co	143011	24in 2220 PWI-3/16in x 1/16in 2 PLY	link
Con-E-Co	143030	30in 2220 PWI-3/16in x 1/16in 2 PLY	link
Con-E-Co	143031	30in 3330 PWI-3/16in x 1/16in 3 PLY	link

BRAND	PART #	DESCRIPTION	LINK
Con-E-Co	143290	Flexco® 1E Non-Hinged Fasteners	link
Con-E-Co	143280	Flexco® 140 Non-Hinged Fasteners	link

Sold by the box. 30in belt requires 1 box, 36in requires 2 boxes.

Con-E-Co	143350	30in Template for 140 Fasteners	link
----------	--------	---------------------------------	----------------------



BRAND	PART #	DESCRIPTION	LINK
Con-E-Co	1236898	Bolt Breaker #1	link



BRAND	PART #	DESCRIPTION	LINK
Con-E-Co	1236900	Power Wrench #1	link



BRAND	PART #	DESCRIPTION	LINK
Con-E-Co	143520	Belt Fastener Power Punch #1	link

BELTING COMPONENTS



SKIRTBOARD RUBBER SOLD BY FOOT

BRAND	PART #	DESCRIPTION	LINK
Con-E-Co	143192	.5in x 4in Wide	link
Con-E-Co	1236955	.5in x 6in Wide	link
Con-E-Co	1236956	.5in x 12in Wide	link
Con-E-Co	1236885	3/8in x 6in Wide	link
Con-E-Co	1236888	3/8in x 9in Wide	link
Con-E-Co	1236886	3/8in x 12in Wide	link
Con-E-Co	143199	1in x 4in Wide	link

REAR SIDE SKIRTING

BRAND	PART #	DESCRIPTION	LINK
Con-E-Co	0233484	Rear Side Skirting 54in Long x 14.16in x 5in x .25in Thick No Holes. 2 Required.	link
Con-E-Co	740147149	Rear Side Skirting 48in Long x 16in x 6.75in x .25in Thick With Holes. 2 Required.	link



BACK SKIRTING

BRAND	PART #	DESCRIPTION	LINK
Con-E-Co	0215223	34in x 12in x .25in Thick (36in Aggregate Bin) 1 Required	link



REAR SKIRTING

BRAND	PART #	DESCRIPTION	LINK
Con-E-Co	0215229	32.5in x 25in x 12in x 3/8in Thick (30in) (Stacker) 1 Required	link



CONVEYOR BELTING

BRAND	PART #	DESCRIPTION	LINK
McNeilus	1236879	30in Conveyor Belt 2 PLY 220 3/16in X 1/16in	link

BRAND	PART #	DESCRIPTION	LINK
McNeilus	1236894	Flexco® 1E Non-Hinged Fasteners	link
McNeilus	1236892	Flexco® 140E Non-Hinged Fasteners	link

PAGE
INTENTIONALLY
LEFT BLANK

PILLOW BLOCK BEARINGS



PILLOW BLOCK BEARINGS

BRAND	PART #	DESCRIPTION	LINK
Stephens	126815	2in Plant Conveyor Pillow Block Bearing	link
Stephens	126821	2 15/16in Pillow Block Bearing	link
Stephens	023017	2-15/16in Head Pulley Pillow Block Bearings	link
Stephens	126816	2-3/16in Standard Duty Pillow Block Bearing	link
Con-E-Co	1237237	1-11/16in Pillow Block Bearing	link
Liddell	P2BE215R2	2-15/16in Head Pulley Pillow Block Bearings	link
Liddell	900046018	Pillow Block Bearings	link



FLANGE BEARINGS



FLANGED BEARINGS

BRAND	PART #	DESCRIPTION	LINK
Stephens	F3U232N	4-Bolt Flange Mount Bearing	link
Stephens	A127A93	2-7/16in Plant Conveyor Pillow Block Bearing	link
Belgrade	F4BSC208	1.5in 4 Bolt Flange Bearing	link
Belgrade	F4BSC211	2in Four Bolt Flange Bearing	link
Con-E-Co	1237244	4-Bolt Flange Mount Bearing	link
Con-E-Co	1237247	2-7/16in 4 Bolt Flange Bearing	link
Con-E-Co	151650	4 Bolt Flange Bearing	link



BRAND	PART #	DESCRIPTION	LINK
Vince Hagan	060684	10in Cement Auger Top Bearing	link

BIN LEVEL INDICATORS



74011218

BRAND	PART #	DESCRIPTION	LINK
McNeilus	74011218	Single Vane Banana Paddle	link

BRAND	PART #	DESCRIPTION	LINK
McNeilus	74011219	Bin Level Indicator Flex Coupling	link



74011219



74011216M

BRAND	PART #	DESCRIPTION	LINK
McNeilus	74011216M	115VAC Bin Level Indicator Motor with Terminals	link

BRAND	PART #	DESCRIPTION	LINK
Johnson-Ross	5576757	Bin Level Indicator Single Vane Banana Paddle For Light to Average Weight Material	link



5576757



5578006

BRAND	PART #	DESCRIPTION	LINK
Johnson-Ross	5578006	Bin Level Indicator Flex Coupling	link

BRAND	PART #	DESCRIPTION	LINK
Johnson-Ross	5576950	Rotary Bin Level Indicator	link



5576950

BIN LEVEL INDICATORS



55PS000962

BRAND	PART #	DESCRIPTION	LINK
Johnson-Ross	55PS000962	36in Long .25in Diameter Galvanized Extension Rod	link

BRAND	PART #	DESCRIPTION	LINK
Johnson-Ross	5576756	Large Three Vane Bin Level Indicator Paddle	link



5576756



5578007

BRAND	PART #	DESCRIPTION	LINK
Johnson-Ross	5578007	Bin Level Indicator Top Mount Plate	link

BRAND	PART #	DESCRIPTION	LINK
Erie Strayer	54483	Rotary Bin Level Indicator	link



54483



54613

BRAND	PART #	DESCRIPTION	LINK
Erie Strayer	54613	Bin Level Indicator Four Vane Paddle	link

BIN LEVEL INDICATORS



59213

BRAND	PART #	DESCRIPTION	LINK
Erie Strayer	59213	Single Vane Banana Paddle	link



183011912

BRAND	PART #	DESCRIPTION	LINK
Stephens	183011912	Rotary Bin Level Indicator	link



S2B8003

BRAND	PART #	DESCRIPTION	LINK
Stephens	S2B8003	Top Mount Bindicator	link

BRAND	PART #	DESCRIPTION	LINK
Stephens	S12B9087	23ft Top Mount Mid Level Bindicator	link

BRAND	PART #	DESCRIPTION	LINK
Stephens	S10B8780	10ft Top Mount Mid Level Bindicator	link



S10B8780



4160109

BRAND	PART #	DESCRIPTION	LINK
Stephens	4160109	115VAC Bin Level Indicator Motor with Terminals	link

BRAND	PART #	DESCRIPTION	LINK
Monitor	14141	Large Three Vane Bin Level Indicator Paddle	link

14141



BIN LEVEL INDICATORS



GRP3

BRAND	PART #	DESCRIPTION	LINK
Stephens	GRP3	Bin Level Indicator Single Vane Paddle For Heavy Material up	link

BRAND	PART #	DESCRIPTION	LINK
Stephens	GRSS1	Solid Shaft Coupler	link



GRSS1



7300022

BRAND	PART #	DESCRIPTION	LINK
Stephens	7300022	Bin Level Indicator Top Mount Plate	link

BRAND	PART #	DESCRIPTION	LINK
Stephens	11313	Bin Level Indicator Motor with Terminals	link



11313

BIN LEVEL INDICATORS



183311

BRAND	PART #	DESCRIPTION	LINK
Monitor	183311	Rotary Bin Level Indicator	link

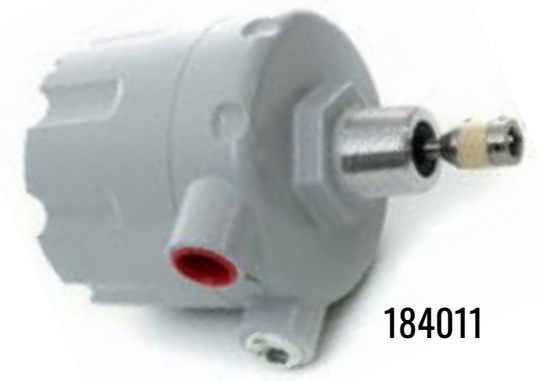

184011

BRAND	PART #	DESCRIPTION	LINK
Monitor	184011	Rotary Bin Level Indicator Model KAX (Hazardous Location Approved)	link



78150

BRAND	PART #	DESCRIPTION	LINK
Monitor	78150	Binatrol Diaphragm Style Bin Level Monitor	link



10102

BRAND	PART #	DESCRIPTION	LINK
Monitor	10102	Bin Level Indicator Top Mount Plate	link



185111

BRAND	PART #	DESCRIPTION	LINK
Monitor	185111	Self-Validating Rotary Bin Level Indicator	link



14161

BRAND	PART #	DESCRIPTION	LINK
Monitor	14161	Two Vane Collapsible	link

BIN LEVEL INDICATORS

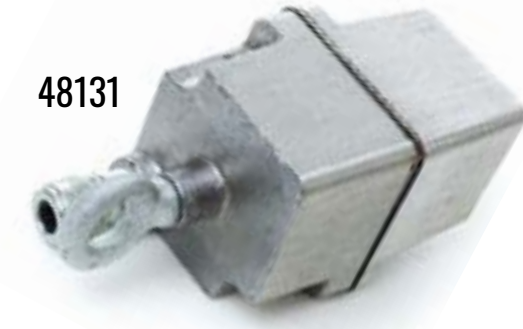

48131

BRAND	PART #	DESCRIPTION	LINK
Monitor	48131	TC-3 Tilt Switch for Aggregate Bin Level Indication	link

BRAND	PART #	DESCRIPTION	LINK
Monitor	14156	Bin Level Indicator Four Vane Paddle	link



14156



11313

BRAND	PART #	DESCRIPTION	LINK
Monitor	11313	115VAC Bin Level Indicator Motor with Terminals	link



11175148

BRAND	PART #	DESCRIPTION	LINK
Monitor	11175148	48in Paddle Extension Pipe	link



13335

BRAND	PART #	DESCRIPTION	LINK
Monitor	13335	Bin Level Indicator Flex Coupling - Springflex	link

BRAND	PART #	DESCRIPTION	LINK
Monitor	14146	Three Vane Bin Level Indicator Paddle	link



14146

BIN LEVEL INDICATORS



183011

BRAND	PART #	DESCRIPTION	LINK
Monitor	183011	Rotary Bin Level Indicator	link

BRAND	PART #	DESCRIPTION	LINK
-------	--------	-------------	------

Monitor 11175130 Bin Level Indicator 30in Paddle Extension Pipe Rod

[link](#)



11175130



180112

BRAND	PART #	DESCRIPTION	LINK
-------	--------	-------------	------

Monitor 180112 Bin Indicator Litebox with 1 Sensor

[link](#)

BRAND	PART #	DESCRIPTION	LINK
-------	--------	-------------	------

Monitor 11174124 24in Shaft Extension Guard

[link](#)



11174124

BRAND	PART #	DESCRIPTION	LINK
-------	--------	-------------	------

Monitor 11174136 36" Guard

[link](#)



KA183021

BRAND	PART #	DESCRIPTION	LINK
-------	--------	-------------	------

Monitor KA183021 Bin Level Indicator

[link](#)

BIN LEVEL INDICATORS



14193

BRAND	PART #	DESCRIPTION	LINK
-------	--------	-------------	------

Monitor 14193 Single Vane Banana Paddle For Light to Average Weight Material

[link](#)

BRAND	PART #	DESCRIPTION	LINK
-------	--------	-------------	------

Monitor 14145 Single Vane Paddle For Heavy Material up to 1.5in Diameter

[link](#)



14145



11175116

BRAND	PART #	DESCRIPTION	LINK
-------	--------	-------------	------

Monitor 11175116 Carbon Steel 76in Paddle Extension Pipe

[link](#)

BRAND	PART #	DESCRIPTION	LINK
-------	--------	-------------	------

BinMaster 2990412 48in Paddle Extension Pipe

[link](#)



2990412



7300022

BRAND	PART #	DESCRIPTION	LINK
-------	--------	-------------	------

BinMaster 7300022 Bin Level Indicator Top Mount Plate

[link](#)

BIN LEVEL INDICATORS



7300504C

BRAND	PART #	DESCRIPTION	LINK
BinMaster	7300504C	Self-Validating Rotary Bin Level Indicator	link

BRAND	PART #	DESCRIPTION	LINK
BinMaster	7300016	High Level Tilt Switch	link



7300016



7300119

BRAND	PART #	DESCRIPTION	LINK
BinMaster	7300119	Rotary Bin Level Indicator	link

BRAND	PART #	DESCRIPTION	LINK
BinMaster	7300020	Bin Level Indicator Side Mount Plate	link



7300020



7300504M

BRAND	PART #	DESCRIPTION	LINK
BinMaster	7300504M	Rotary Bin Level Indicator	link

BRAND	PART #	DESCRIPTION	LINK
BinMaster	2990004	Solid Coupler	link



2990004

BIN LEVEL INDICATORS



4160283

BRAND	PART #	DESCRIPTION	LINK
BinMaster	4160283	Stainless Steel Top Mount Flexible Shaft Coupler	link

BRAND	PART #	DESCRIPTION	LINK
BinMaster	2990411	Galvanized Shaft Extension with Paddle Coupling 36in x 1/4in	link



2990411



4160154

BRAND	PART #	DESCRIPTION	LINK
BinMaster	4160154	Single Vane Banana Paddle	link

BRAND	PART #	DESCRIPTION	LINK
Bindicator	H19	Bin Level Indicator Top Mount Plate	link



H19



LAR110070

BRAND	PART #	DESCRIPTION	LINK
Bindicator	LAR110070	Heavy Duty Motor	link

BRAND	PART #	DESCRIPTION	LINK
Bindicator	LAR111037	Insertable Single Vane Banana Paddle Assembly	link



LAR111037

BIN LEVEL INDICATORS



154766

BRAND	PART #	DESCRIPTION	LINK
Con-E-Co	154766	Bin Level Indicator	link

BRAND	PART #	DESCRIPTION	LINK
Con-E-Co	154810	Bin Level Indicator Single Vane Paddle	link



154810



1374896

BRAND	PART #	DESCRIPTION	LINK
Con-E-Co	1374896	Bin Level Indicator Single Vane Banana Paddle For Light to Average Weight Material	link

BRAND	PART #	DESCRIPTION	LINK
Con-E-Co	0111219	Bin Level Indicator Flex Coupling	link



0111219



1171313

BRAND	PART #	DESCRIPTION	LINK
Con-E-Co	1171313	Bin Level Indicator Motor with Terminals	link

BRAND	PART #	DESCRIPTION	LINK
McNeilus	740111216B	Heavy Duty Motor	link



740111216B

BIN LEVEL INDICATORS



2120203456

BRAND	PART #	DESCRIPTION	LINK
Rexcon	2120203456	Rotary Bin Level Indicator	link

BRAND	PART #	DESCRIPTION	LINK
Vince Hagan	011156	Silo Safety Relief Valve with SS Cover	link



011156



VCP2731C

BRAND	PART #	DESCRIPTION	LINK
WAM	VCP2731C	Silo Top Pressure Relief Valve-10" Diameter - Stainless Cover	link

BRAND	PART #	DESCRIPTION	LINK
WAM	VCP2732C	Silo Top Pressure Relief Valve	link



VCP2732C



KSVCP2731C001

BRAND	PART #	DESCRIPTION	LINK
WAM	KSVCP2731C001	Repair Kit for VCP273 Silo Top Pressure Relief Valves	link

BRAND	PART #	DESCRIPTION	LINK
WAM	ILTC2	Bin Level Indicator with Paddle	link



ILTC2

BUTTERFLY VALVES

30020011010119



30060011010119



30100011010119

FULL CUT WAFER BODY

BRAND	PART #	DESCRIPTION	LINK
Bray	30020011010119	2in Butterfly Valve	link
Bray	30025011010119	2.5in Butterfly Valve	link
Bray	30030011010119	3in Butterfly Valve	link
Bray	30040011010119	4in Butterfly Valve	link
Bray	30050011010119	5in Butterfly Valve	link
Bray	30060011010119	6in Butterfly Valve	link
Bray	30100011010119	10in Butterfly Valve	link

UNDER CUT WAFER BODY



30080011011119

BRAND	PART #	DESCRIPTION	LINK
Bray	30040011011119	4in Butterfly Valve	link
Bray	30060011011119	6in Butterfly Valve	link
Bray	30080011011119	8in Butterfly Valve	link
Bray	30100011011119	10in Butterfly Valve	link
Bray	30120011011119	12in Butterfly Valve	link

BUTTERFLY VALVES

31060011010119



FULL CUT LUG BODY

BRAND	PART #	DESCRIPTION	LINK
Bray	31060011010119	4in Butterfly Valve	link

30040011010118



30100011010118

FULL CUT WAFER BODY EPDM SEAL

BRAND	PART #	DESCRIPTION	LINK
Bray	30020011010118	2in Butterfly Valve	link
Bray	30030011010118	2.5in Butterfly Valve	link
Bray	30040011010118	3in Butterfly Valve	link
Bray	30060011010118	4in Butterfly Valve	link
Bray	30100011010118	5in Butterfly Valve	link
Bray	30120011010118	6in Butterfly Valve	link

FULL CUT WAFER BODY SS DISC EPDM SEAL



30020011010124

BRAND	PART #	DESCRIPTION	LINK
Bray	30020011010124	2in Butterfly Valve	link
Bray	30020011010124HK	2in Butterfly Valve with Handle	link

BUTTERFLY VALVES



30040011010169

FULL CUT WAFER BODY SS DISC AND STEM EPDM SEAL

BRAND	PART #	DESCRIPTION	LINK
Bray	30020011010169	2in Butterfly Valve	link
Bray	30030011010169	3in Butterfly Valve	link
Bray	30040011010169	4in Butterfly Valve	link
Bray	30080011010169	8in Butterfly Valve	link

FULL CUT WAFER BODY BUNA-N SEAL

BRAND	PART #	DESCRIPTION	LINK
Bray	30060011010713	6in Butterfly Valve	link



30060011010713



30100011011713

UNDER CUT WAFER BODY BUNA-N SEAL

BRAND	PART #	DESCRIPTION	LINK
Bray	30100011011713	6in Butterfly Valve	link



FULL CUT LUG BODY SS DISC AND STEM EPDM SEAL

BRAND	PART #	DESCRIPTION	LINK
Bray	31025011010375	2.5in Butterfly Valve	link
Bray	31100011010375	10in Butterfly Valve	link
Bray	31180011010375	18in Butterfly Valve	link

BUTTERFLY VALVES



31080011010390

31120011010390

31060011010390

31180011010390

FULL CUT LUG BODY NYLON COATED DISC SS STEM EPDM SEAL

BRAND	PART #	DESCRIPTION	LINK
Bray	31020011010390	2in Butterfly Valve	link
Bray	31030011010390	3in Butterfly Valve	link
Bray	31060011010390	6in Butterfly Valve	link
Bray	31080011010390	8in Butterfly Valve	link
Bray	31120011010390	12in Butterfly Valve	link
Bray	31180011010390	18in Butterfly Valve	link



31060011011390

UNDER CUT LUG BODY NYLON COATED DISC SS STEM EPDM SEAL

BRAND	PART #	DESCRIPTION	LINK
Bray	31060011011390	6in Butterfly Valve	link
Bray	31100011011390	10in Butterfly Valve	link
Bray	31120011011390	12in Butterfly Valve	link

SEALS, SLEEVES, AND SWITCHES



30100070400560

BUNA-N STEM SEAL

BRAND	PART #	DESCRIPTION	LINK
Bray	30100070400560	For 10-12in Valves	link

ADAPTER SLEEVE

30141971500580

BRAND	PART #	DESCRIPTION	LINK
Bray	30101471500580	10mm-14mm	link
Bray	30141971500580	14mm-19mm	link
Bray	30161971500580	16mm-19mm	link
Bray	30223071500580	22mm-30mm	link



30101471500580

30223071500580

30161971500580

SOLENOID VALVE



BRAND	PART #	DESCRIPTION	LINK
Bray	63025021410536	Series 63 120VAC Solenoid Valve	link

LIMIT SWITCH

50040612610532

BRAND	PART #	DESCRIPTION	LINK
Bray	50040612610532	Series 50 Limit Switch	link
Bray	5A0000126A2536	Limit Switch	link
Bray	5B000022601534	Limit Switch Mounting Kit	link
Bray	50160024603536	Limit Switch Adapter Kit	link



50160024603536

5A0000126A2536

ACTUATORS



92063011300532



92083011300532



92093011300532



92128011300532

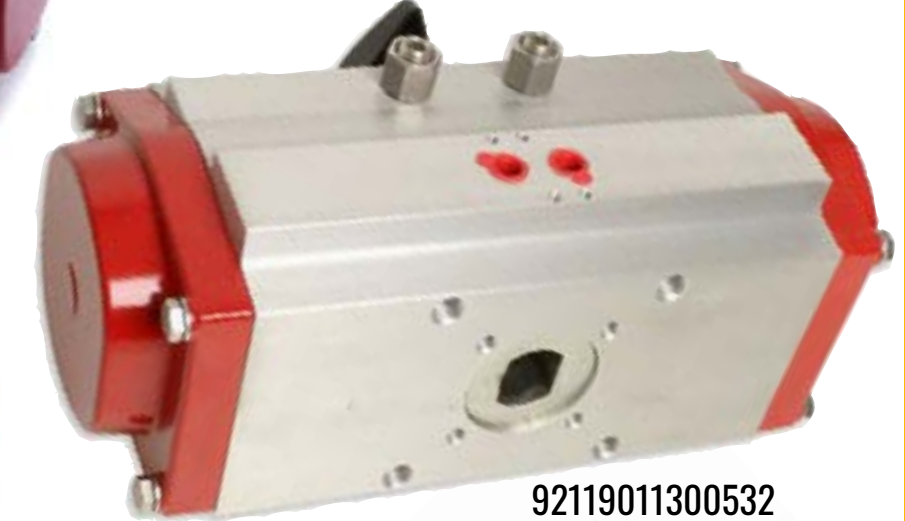

92119011300532



92255011356532



92160011300532

AIR ACTUATOR

BRAND	PART #	DESCRIPTION	LINK
Bray	92063011300532	S92/63 Air Actuator - 14mm Double Acting	link
Bray	92083011300532	S92/83 Air Actuator - 19mm Double Acting	link
Bray	92093011300532	S92/93 Air Actuator - 19mm Double Acting	link
Bray	92119011300532	S92/119 Air Actuator - 30mm Double Acting	link
Bray	92128011300532	S92/128 Air Actuator - 30mm Double Acting	link
Bray	92160011300532	S92/160 Air Actuator - 30mm Double Acting	link
Bray	92255011356532	S92/255 Air Actuator	link

ACTUATORS



SINGLE ACTING SPRING RETURN AIR ACTUATOR

BRAND	PART #	DESCRIPTION	LINK
Bray	93063511300532	93 Spring Return Air Actuator - Single Acting	link
Bray	93083511300532	93/83-5 Spring Return Air Actuator - 19mm Single Acting	link
Bray	93093511300532	93/93-5 Spring Return Air Actuator - 19mm Single Acting	link
Bray	93119511300532	93 Spring Return Air Actuator - Single Acting	link
Bray	93119611300532	93 Spring Return Air Actuator - Single Acting	link
Bray	93160511300532	93 Spring Return Air Actuator - Single Acting	link
Bray	93210611300532	93 Spring Return Air Actuator - Single Acting	link

BUTTERFLY VALVES



SEAL AND BEARING REPAIR KIT

BRAND	PART #	DESCRIPTION	LINK
Bray	92063021903536	Actuator Repair and Seal Kit	link
Bray	92083021903536	Butterfly Valve Actuator Seal and Bearing Repair Kit	link
Bray	92083021911536	Butterfly Valve Actuator Seal and Bearing Repair Kit	link
Bray	92092021903536	Butterfly Valve Actuator Seal and Bearing Repair Kit	link



PLANT SEAL AND BEARING REPAIR KIT

BRAND	PART #	DESCRIPTION	LINK
Bray	92118021903536	Plant Butterfly Valve Actuator Seal and Bearing Repair Kit	link
Bray	92127021903536	Plant Butterfly Valve Actuator Seal and Bearing Repair Kit	link

BUTTERFLY VALVES

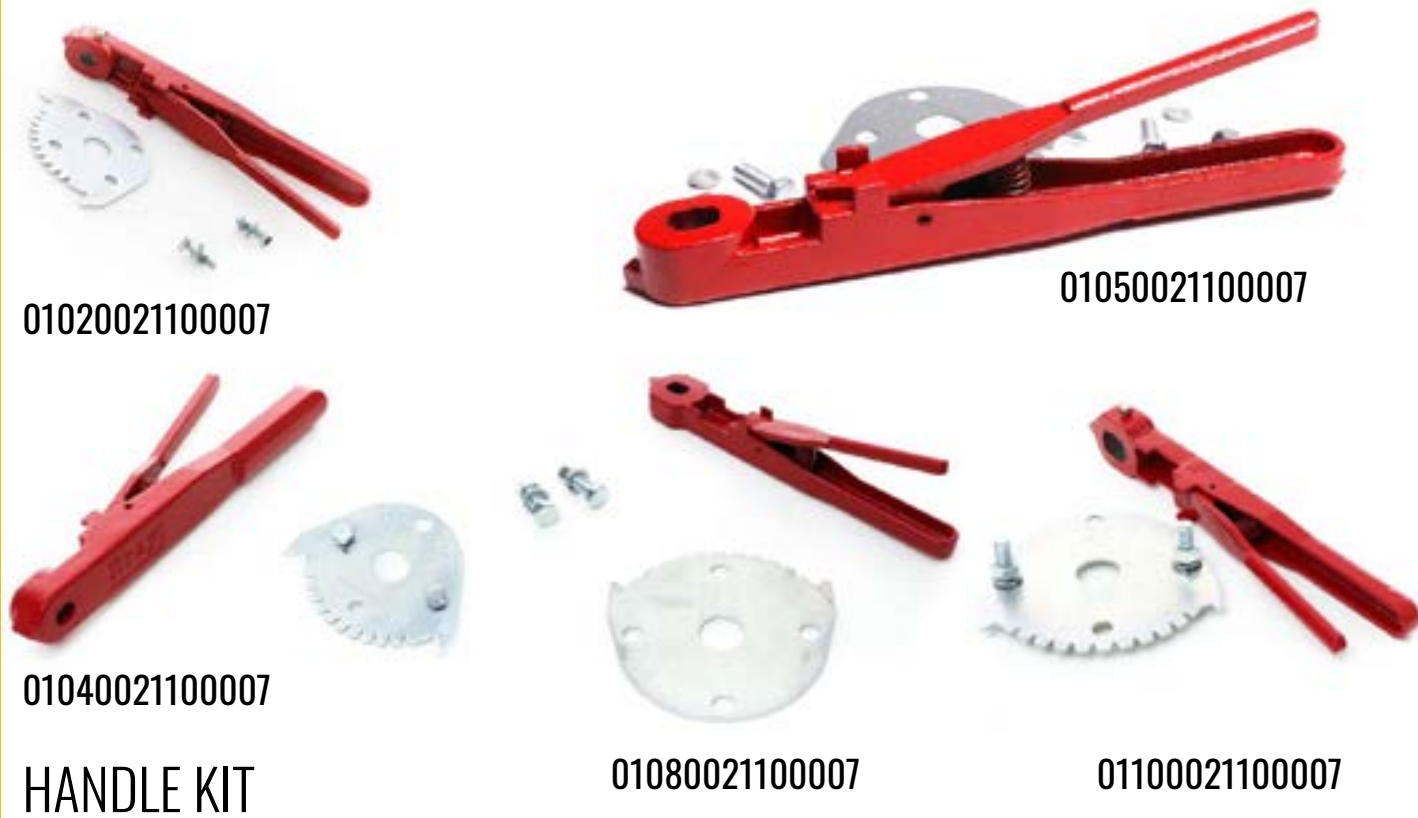

01020021100007

01050021100007

01040021100007

01080021100007

01100021100007

HANDLE KIT

BRAND	PART #	DESCRIPTION	LINK
Bray	01020021100007	Butterfly Valve Handle Kit - 2in, 2.5in, and 3in	link
Bray	01040021100007	Butterfly Valve Handle Kit - 4in	link
Bray	01050021100007	Butterfly Valve Handle Kit - 5in and 6in	link
Bray	01080021100007	Butterfly Valve Handle Kit - 8in	link
Bray	01100021100007	Butterfly Valve Handle Kit - 10in	link



3317051

BALL VALVE ASSEMBLY

BRAND	PART #	DESCRIPTION	LINK
Bray	3317051	3in Series 8000 Flow-Tek Ball Valve Assembly	link

BUTTERFLY VALVES



350001

9000B122600534

9000A022600536

9000E022600536

MOUNTING KIT

BRAND	PART #	DESCRIPTION	LINK
Bray	350001	Stainless Steel Mounting Kit	link
Bray	9000A022600536	Air Actuator to Valve Mounting Bolt Kit	link
Bray	9000B122600534	B1 Mounting Kit	link
Bray	9000E022600536	Butterfly Valve Mounting Bolt Kit	link

WAFER BODY

BRAND	PART #	DESCRIPTION	LINK
Bray	20015011010124	1.5in Wafer Body 1.5in EPDM Seal Butterfly Valve	link



20015011010124

BUTTERFLY VALVES



EPDM SEAT FOR S20

BRAND	PART #	DESCRIPTION	LINK
Bray	20010092801561	Butterfly Valve 1in EPDM Seat	link
Bray	20015092801561	Butterfly Valve 1.5in EPDM Seat	link
Bray	20020092801560	Butterfly Valve 2in EPDM Seat	link
Bray	20020092801561	Butterfly Valve 2in EPDM Seat	link
Bray	20030092801561	Butterfly Valve 3in EPDM Seat	link
Bray	20040092801561	Butterfly Valve 4in EPDM Seat	link
Bray	20080092801561	Butterfly Valve 8in EPDM Seat	link
Bray	20100092801561	Butterfly Valve 10in EPDM Seat	link
Bray	20120092801561	Butterfly Valve 12in EPDM Seat	link



BUTTERFLY VALVES

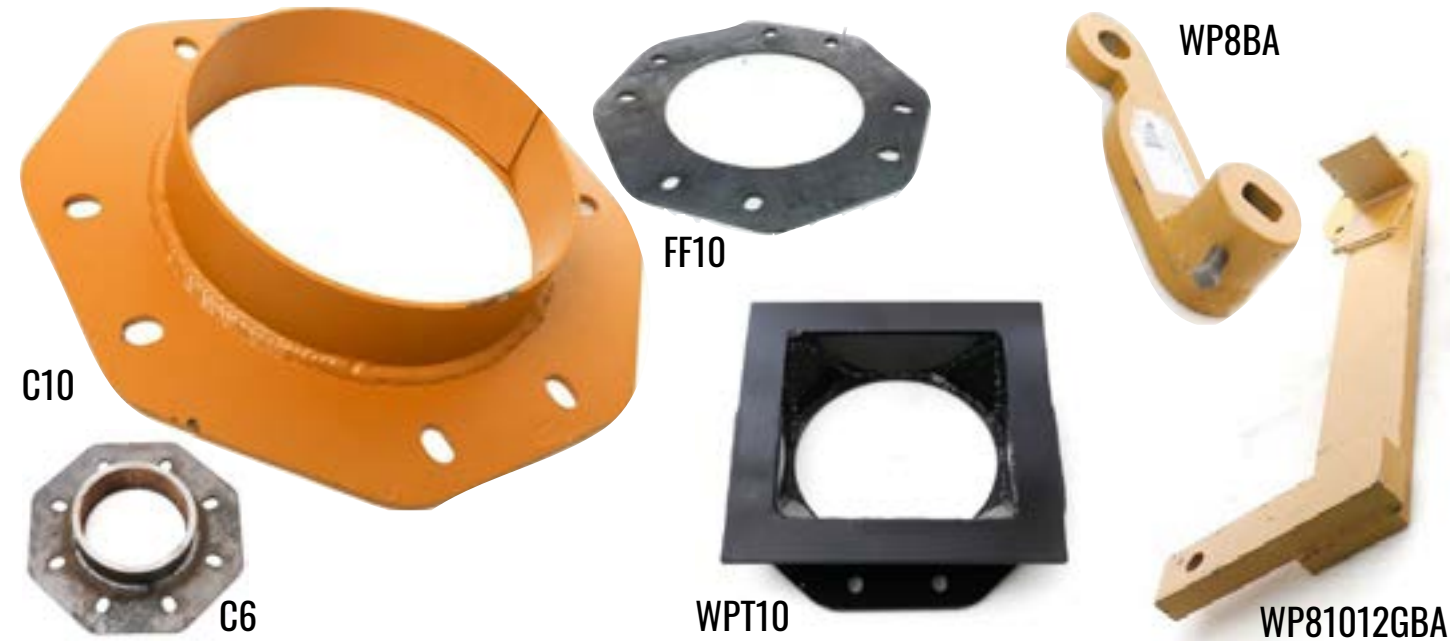

STEPHENS ACCESSORIES

BRAND	PART #	DESCRIPTION	LINK
Stephens	C10	Boot Shroud Flange for 10in Bray Butterfly Valve	link
Stephens	C6	Boot Flange with Shroud Ring for 6in Bray Butterfly Valve	link
Stephens	FF10	10in Flat Straight Flange for 10in Bray Butterfly Valve	link
Stephens	WP81012GBA	Long Wrench Arm for 8in-12in Bray Butterfly Valve	link
Stephens	WP8BA	Short Wrench Arm for 8in Bray Butterfly Valve	link
Stephens	WPC10	Boot Flange with Shroud Ring for 10in Bray Butterfly Valve	link
Stephens	WPT8	Transition Flange from Square Gate to 8in Bray	link
Stephens	WPT10	Transition Flange from Rotary Gate to 10in Bray Butterfly Valve	link
Stephens	WPT12	Transition Flange	link



FULL CUT LUG BODY

BRAND	PART #	DESCRIPTION	LINK
Con-E-Co	1142426	Nylon Coated Disc SS Stem EPDM Seal 18in Butterfly Valve	link

1142426

BUTTERFLY VALVES



FULL CUT WAFER

BRAND	PART #	DESCRIPTION	LINK
Con-E-Co	1142417	2in Butterfly Valve	link
Con-E-Co	1142418	3in Butterfly Valve	link
Con-E-Co	1142419	4in Butterfly Valve	link
Con-E-Co	1142420	6in Butterfly Valve	link

UNDER CUT WAFER



BRAND	PART #	DESCRIPTION	LINK
Con-E-Co	1142421	8in Butterfly Valve	link
Con-E-Co	1142422	10in Butterfly Valve	link
Con-E-Co	1469301	12in Butterfly Valve	link

UNDER CUT LUG BODY NYLON COATED DISC SS STEM EPDM SEAL

BRAND	PART #	DESCRIPTION	LINK
Con-E-Co	1142423	10in Butterfly Valve	link
Con-E-Co	1142424	12in Butterfly Valve	link



BUTTERFLY VALVES



AIR ACTUATOR

BRAND	PART #	DESCRIPTION	LINK
Con-E-Co	1142427	S92/63 Air Actuator - 14mm Double Acting	link
Con-E-Co	1142428	S92/83 Air Actuator - 19mm Double Acting	link
Con-E-Co	1142429	S92/119 Air Actuator - 30mm Double Acting	link



ACTUATOR REPAIR & SEAL KIT

BRAND	PART #	DESCRIPTION	LINK
Con-E-Co	1236595	2in Actuator Repair & Seal Kit	link



DOUBLE ACTING AIR ACTUATOR

BRAND	PART #	DESCRIPTION	LINK
Con-E-Co	1142427	Air Actuator - Double Acting for 2in Bray Valves	link
Con-E-Co	1142428	Air Actuator - Double Acting for 3in-6in Bray Valves	link
Con-E-Co	1142429	Air Actuator - Double Acting for 8in and 10in Bray	link

BUTTERFLY VALVES

BUTTERFLY VALVE AND ACTUATOR ASSEMBLY

BRAND	PART #	DESCRIPTION	LINK
Con-E-Co	1142433	2in Assembly	link
Con-E-Co	1142434	3in Assembly	link

BUTTERFLY VALVE AND ACTUATOR FULL CUT ASSEMBLY

BRAND	PART #	DESCRIPTION	LINK
Con-E-Co	1142435	4in S30 Assembly	link



BUTTERFLY VALVE AND ACTUATOR UNDER CUT ASSEMBLY

BRAND	PART #	DESCRIPTION	LINK
Con-E-Co	1142437	6in S30 Assembly	link
Con-E-Co	1142443	8in S30 Assembly	link
Con-E-Co	1489261	10in S30 Assembly	link
Con-E-Co	1474296	12in S30 Assembly	link

BUTTERFLY VALVES

HANDLE KIT

BRAND	PART #	DESCRIPTION	LINK
Con-E-Co	1474341	Handle Kit for 2in 2.5in and 3in Butterfly Valves	link
Con-E-Co	1458727	Handle Kit for 4in Butterfly Valves	link
Con-E-Co	1550485	Handle Kit for 5in and 6in Butterfly Valves	link
Con-E-Co	1429894	Handle Kit for 8in Butterfly Valves	link
Con-E-Co	1529895	Handle Kit for 10in and 12in Butterfly Valves	link



BRAND	PART #	DESCRIPTION	LINK
Con-E-Co	1257595	Limit Switch With Mounting Kit	link



BRAND	PART #	DESCRIPTION	LINK
Con-E-Co	1273828	Series 63 120VAC Solenoid Valve	link



BRAND	PART #	DESCRIPTION	LINK
Con-E-Co	0146460	Transition Flange from Rotary Gate to 10in Butterfly Valve	link



BRAND	PART #	DESCRIPTION	LINK
Con-E-Co	PL0026	Flat Straight Flange for 10in Bray Butterfly Valve	link

BUTTERFLY VALVES

UNDER CUT WAFER



010295

BRAND	PART #	DESCRIPTION	LINK
Vince Hagan	010295	8in Butterfly Valve	link
Vince Hagan	011455	10in Butterfly Valve	link



013758

011456



012819



013978

AIR ACTUATOR

BRAND	PART #	DESCRIPTION	LINK
Vince Hagan	012819	S92/63 Air Actuator - 14mm Double Acting	link
Vince Hagan	013758	S92/93 Air Actuator - 19mm Double Acting	link
Vince Hagan	013978	S92/83 Air Actuator - 19mm Double Acting	link
Vince Hagan	011456	S92/119 Air Actuator - 30mm Double Acting	link

012580

FULL CUT WAFER

BRAND	PART #	DESCRIPTION	LINK
Vince Hagan	012580	2in Butterfly Valve	link
Vince Hagan	012581	3in Butterfly Valve	link
Vince Hagan	013701	4in Butterfly Valve	link
Vince Hagan	013979	6in Butterfly Valve	link



013979

BUTTERFLY VALVES



011439

BUTTERFLY VALVE AND ACTUATOR ASSEMBLY

BRAND	PART #	DESCRIPTION	LINK
Vince Hagan	011439	2in Assembly	link
Vince Hagan	011440	3in Assembly	link

011440

BUTTERFLY VALVE AND ACTUATOR FULL CUT ASSEMBLY

BRAND	PART #	DESCRIPTION	LINK
Vince Hagan	011438	4in S30 Assembly	link



011438



014147

013977

BUTTERFLY VALVE AND ACTUATOR UNDER CUT ASSEMBLY

BRAND	PART #	DESCRIPTION	LINK
Vince Hagan	013977	6in S30 Assembly	link
Vince Hagan	014147	8in S30 Assembly	link
Vince Hagan	013976	10in S30 Assembly	link
Vince Hagan	014146	12in S30 Assembly	link

013976

014146

BUTTERFLY VALVES



013703

EPDM SEAT FOR S20

011448

011449

014008

BRAND	PART #	DESCRIPTION	LINK
Vince Hagan	011448	Butterfly Valve 2in EPDM Seat	link
Vince Hagan	011449	Butterfly Valve 3in EPDM Seat	link
Vince Hagan	013703	Butterfly Valve 8in EPDM Seat	link
Vince Hagan	014008	Butterfly Valve 10in EPDM Seat	link

FULL CUT WAFER

BRAND	PART #	DESCRIPTION	LINK
Erie Strayer	62415	2in Butterfly Valve	link
Erie Strayer	59943	3in Butterfly Valve	link
Erie Strayer	59942	4in Butterfly Valve	link
Erie Strayer	59941	6in Butterfly Valve	link



62415

59941

UNDER CUT WAFER

BRAND	PART #	DESCRIPTION	LINK
Erie Strayer	62416	8in Butterfly Valve	link
Erie Strayer	59940	10in Butterfly Valve	link
Erie Strayer	59939	12in Butterfly Valve	link



62416

BUTTERFLY VALVES



60348

60349

60350

AIR ACTUATOR

BRAND	PART #	DESCRIPTION	LINK
Erie Strayer	60350	S92/63 Air Actuator - 14mm Double Acting	link
Erie Strayer	60349	S92/83 Air Actuator - 19mm Double Acting	link
Erie Strayer	60348	S92/119 Air Actuator - 30mm Double Acting	link



60012

59938

BUTTERFLY VALVE AND ACTUATOR ASSEMBLY

BRAND	PART #	DESCRIPTION	LINK
Erie Strayer	60012	2in Assembly	link
Erie Strayer	59938	3in Assembly	link

BUTTERFLY VALVE AND ACTUATOR FULL CUT ASSEMBLY

BRAND	PART #	DESCRIPTION	LINK
Erie Strayer	59937	4in S30 Assembly	link



59937



BUTTERFLY VALVE AND ACTUATOR UNDER CUT ASSEMBLY

BRAND	PART #	DESCRIPTION	LINK
Erie Strayer	59936	6in S30 Assembly	link
Erie Strayer	60085	8in S30 Assembly	link
Erie Strayer	59935	10in S30 Assembly	link
Erie Strayer	59934	12in S30 Assembly	link



BRAND	PART #	DESCRIPTION	LINK
Erie Strayer	60352	Limit Switch With Mounting Kit	link

PAGE
INTENTIONALLY
LEFT BLANK

PLANT DUCTING

QUICK FIT PIPES

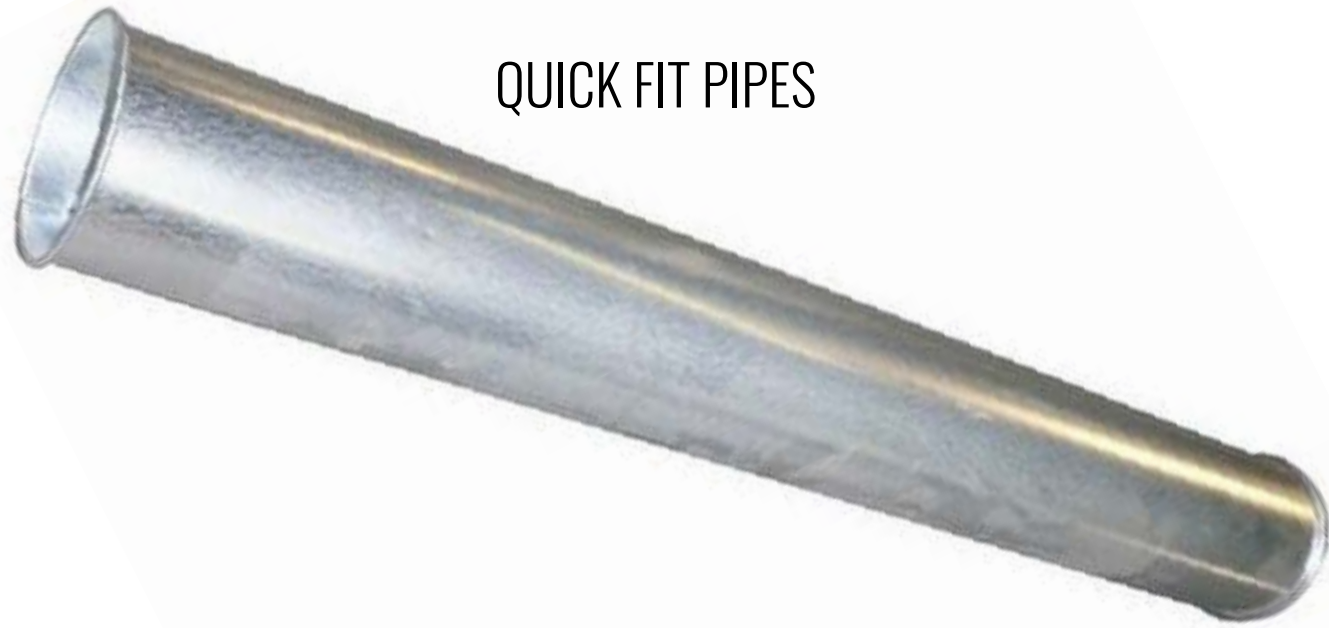

BRAND	PART #	DESCRIPTION	LINK
Nordfab	8040206775	6in x 59.25in Long Snap Duct Pipe	link
Liddell	900166004	6in x 59.25in Long Snap Duct Pipe	link

BRAND	PART #	DESCRIPTION	LINK
Nordfab	8040206777	8in x 59.06in Long Snap Duct Pipe	link
Liddell	900166006	8in x 59.06in Long Snap Duct Pipe	link

BRAND	PART #	DESCRIPTION	LINK
Nordfab	8040206779	10in x 59.06in Long Snap Duct Pipe	link
C&W	SNAP10000	10in x 59.06in Long Snap Duct Pipe	link

BRAND	PART #	DESCRIPTION	LINK
Nordfab	8040206783	14in x 56.75in Long Snap Duct Pipe	link
C&W	SNAP14000	14in x 56.75in Long Snap Duct Pipe	link

BRAND	PART #	DESCRIPTION	LINK
Nordfab	8040206787	14in x 58.75in Long Snap Duct Pipe	link

PLANT DUCTING

ADJUSTABLE NIPPLES



BRAND	PART #	DESCRIPTION	LINK
Nordfab	8040207302	6in Galvanized Steel Adjustable Nipple	link
Liddell	900166065	6in Galvanized Steel Adjustable Nipple	link

BRAND	PART #	DESCRIPTION	LINK
Nordfab	8040207304	8in Galvanized Steel Adjustable Nipple	link
Liddell	900166066	8in Galvanized Steel Adjustable Nipple	link

BRAND	PART #	DESCRIPTION	LINK
Nordfab	8040207308	12in Galvanized Steel Adjustable Nipple	link

BRAND	PART #	DESCRIPTION	LINK
Nordfab	8040207310	14in Galvanized Steel Adjustable Nipple	link

BRAND	PART #	DESCRIPTION	LINK
Nordfab	8040207314	18in Galvanized Steel Adjustable Nipple	link

PLANT DUCTING

QUICK-FIT LONG RADIUS ELBOWS

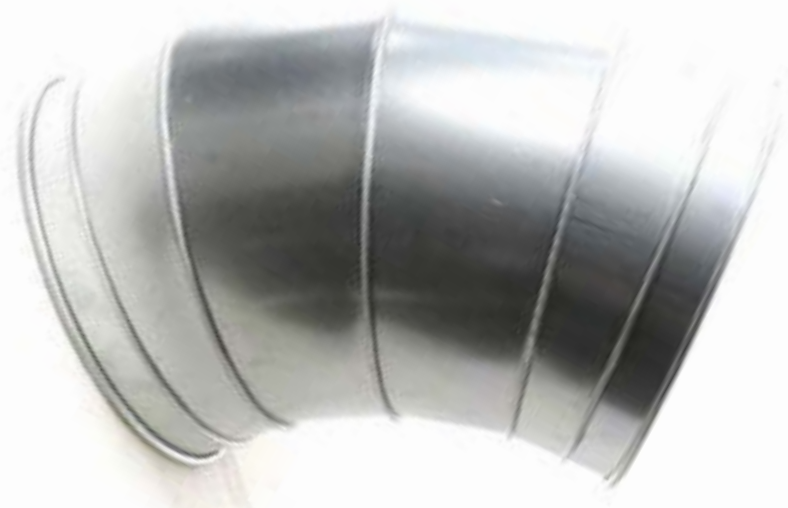

BRAND	PART #	DESCRIPTION	LINK
Nordfab	8010005964	6in 45 Degree Galvanized Steel Elbow	link
BRAND	PART #	DESCRIPTION	LINK
Nordfab	8040400001	8in 30 Degree Galvanized Steel Elbow	link
BRAND	PART #	DESCRIPTION	LINK
Nordfab	8040400002	8in 45 Degree Galvanized Steel Elbow	link
Liddell	900164044	8in 45 Degree Galvanized Steel Elbow	link
BRAND	PART #	DESCRIPTION	LINK
Nordfab	8040400026	14in 45 Degree Galvanized Steel Elbow	link
BRAND	PART #	DESCRIPTION	LINK
Nordfab	8040400034	16in 45 Degree Galvanized Steel Elbow	link
BRAND	PART #	DESCRIPTION	LINK
Nordfab	8040400042	18in 45 Degree Galvanized Steel Elbow	link

PLANT DUCTING

QUICK-FIT LONG RADIUS ELBOWS

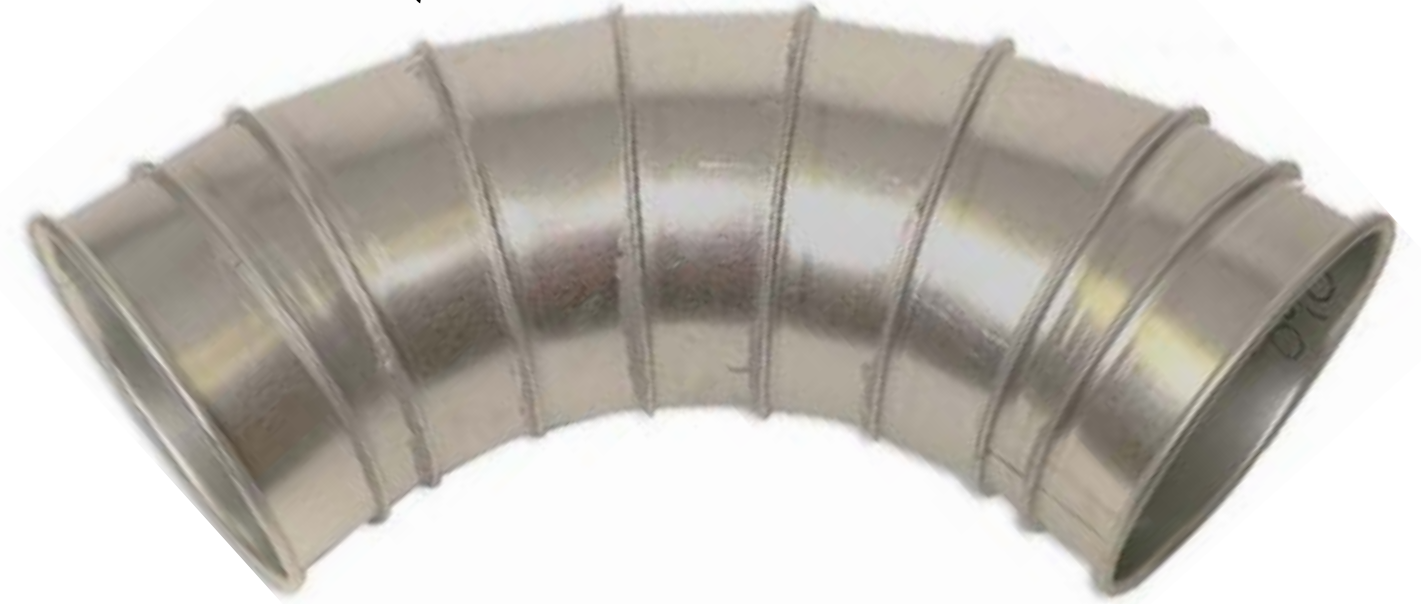

BRAND	PART #	DESCRIPTION	LINK
Nordfab	8010005966	6in 90 Degree Galvanized Steel Elbow	link
C&W	SNAP06200	6in 90 Degree Galvanized Steel Elbow	link
Liddell	900167005	6in 90 Degree Galvanized Steel Elbow	link
BRAND	PART #	DESCRIPTION	LINK
Nordfab	8040400004	8in 90 Degree Galvanized Steel Elbow	link
Liddell	900167006	8in 90 Degree Galvanized Steel Elbow	link
BRAND	PART #	DESCRIPTION	LINK
Nordfab	8040400028	14in 90 Degree Galvanized Steel Elbow	link
C&W	SNAP14200	14in 90 Degree Galvanized Steel Elbow	link
BRAND	PART #	DESCRIPTION	LINK
Nordfab	8040400036	16in 90 Degree Galvanized Steel Elbow	link
BRAND	PART #	DESCRIPTION	LINK
Nordfab	8040400044	18in 90 Degree Galvanized Steel Elbow	link

PLANT DUCTING

QUICK-FIT Y-BRANCHES

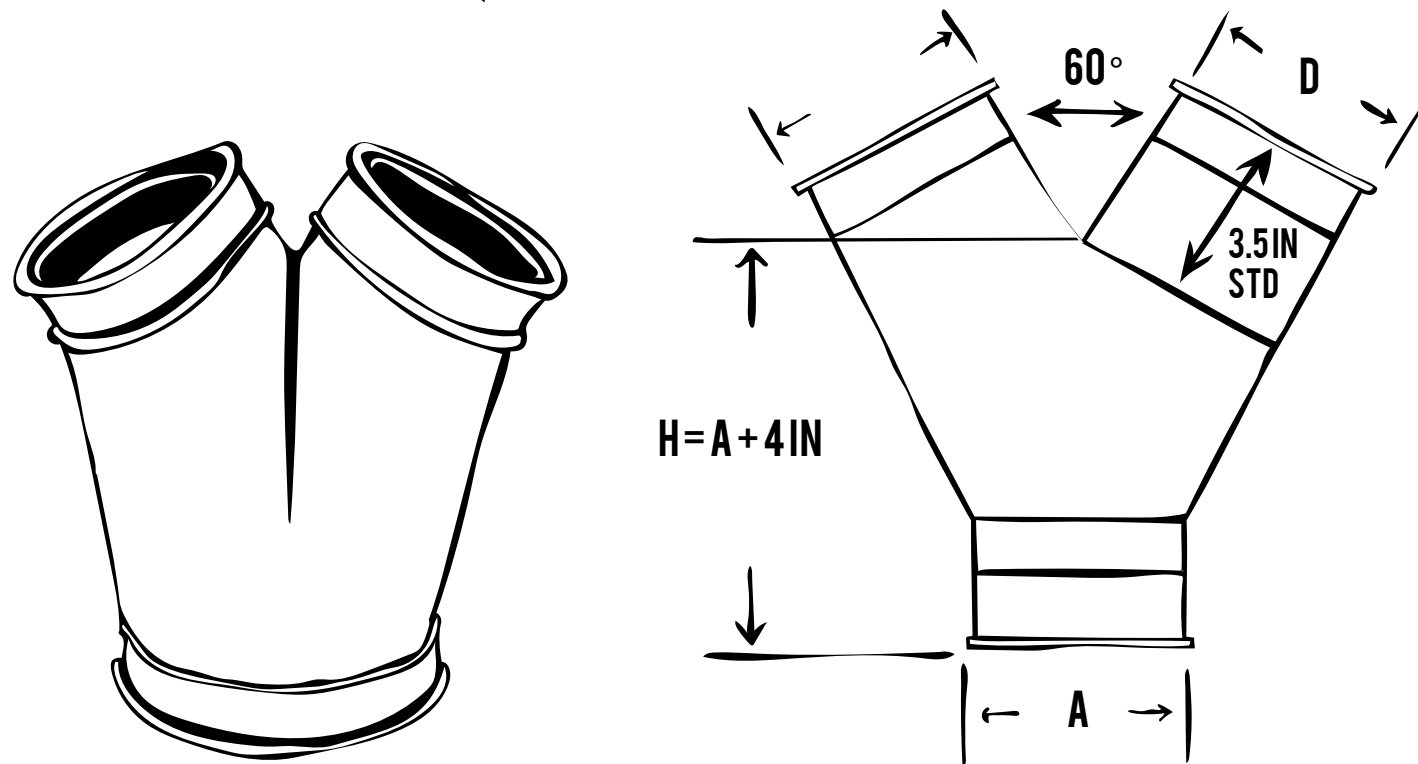

BRAND	PART #	DESCRIPTION	LINK
Nordfab	8040200189	6in Galvanized Steel Y-Branch	link

BRAND	PART #	DESCRIPTION	LINK
Nordfab	8040200292	14in Galvanized Steel Y-Branch	link



QUICK-FIT BRANCH

BRAND	PART #	DESCRIPTION	LINK
Nordfab	8040003146	10in Galvanized Steel Branch	link
C&W	SNAP10850	10in Galvanized Steel Branch	link

PLANT DUCTING

QUICK-FIT REDUCERS

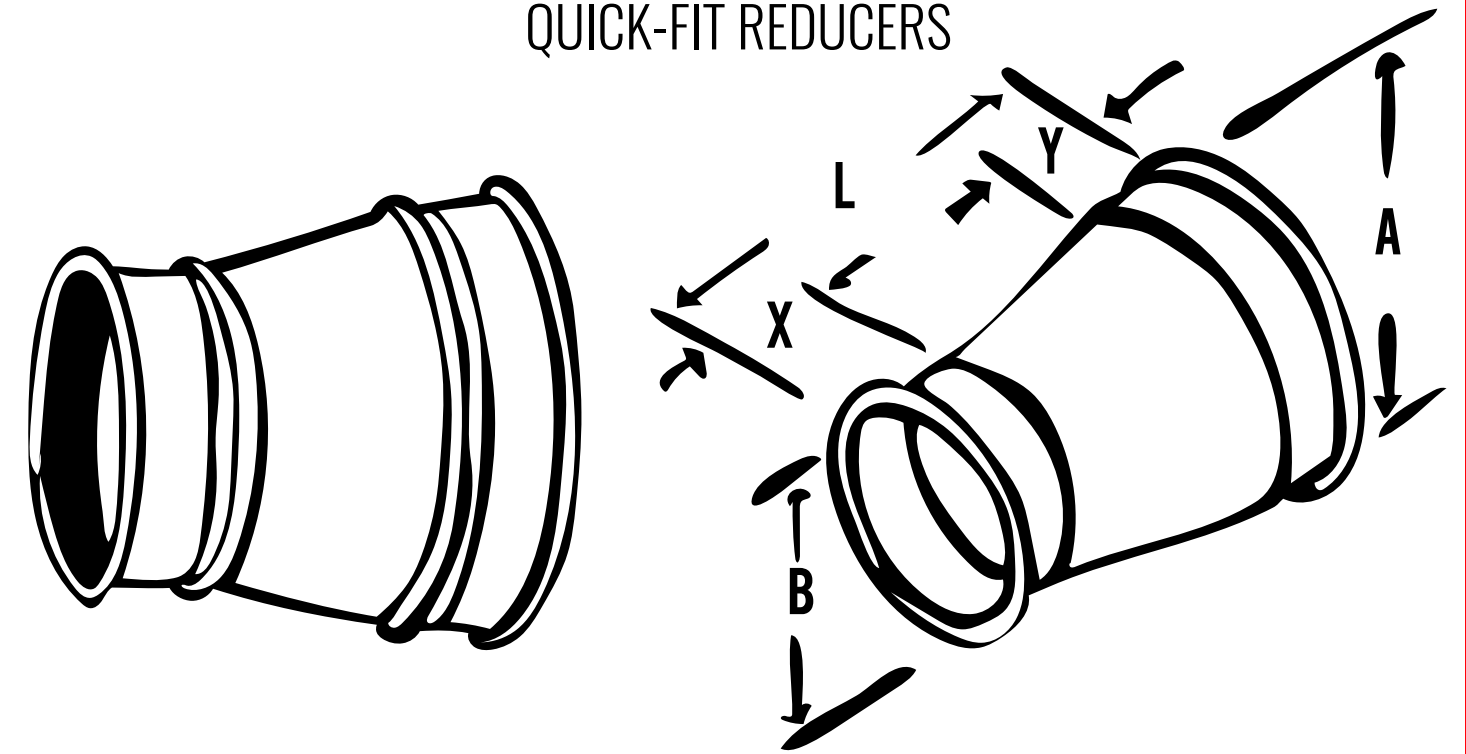

BRAND	PART #	DESCRIPTION	LINK
Nordfab	8040025868	6in Galvanized Steel Reducer	link

BRAND	PART #	DESCRIPTION	LINK
Nordfab	8040025886	10in Galvanized Steel Reducer	link

BRAND	PART #	DESCRIPTION	LINK
Nordfab	8040025908	12in Galvanized Steel Reducer	link

Liddell	900168614	12in Galvanized Steel Reducer	link
---------	-----------	-------------------------------	----------------------

BRAND	PART #	DESCRIPTION	LINK
Nordfab	8040025920	14in Galvanized Steel Reducer	link

BRAND	PART #	DESCRIPTION	LINK
Nordfab	8040025928	6in Galvanized Steel Reducer	link

PLANT DUCTING

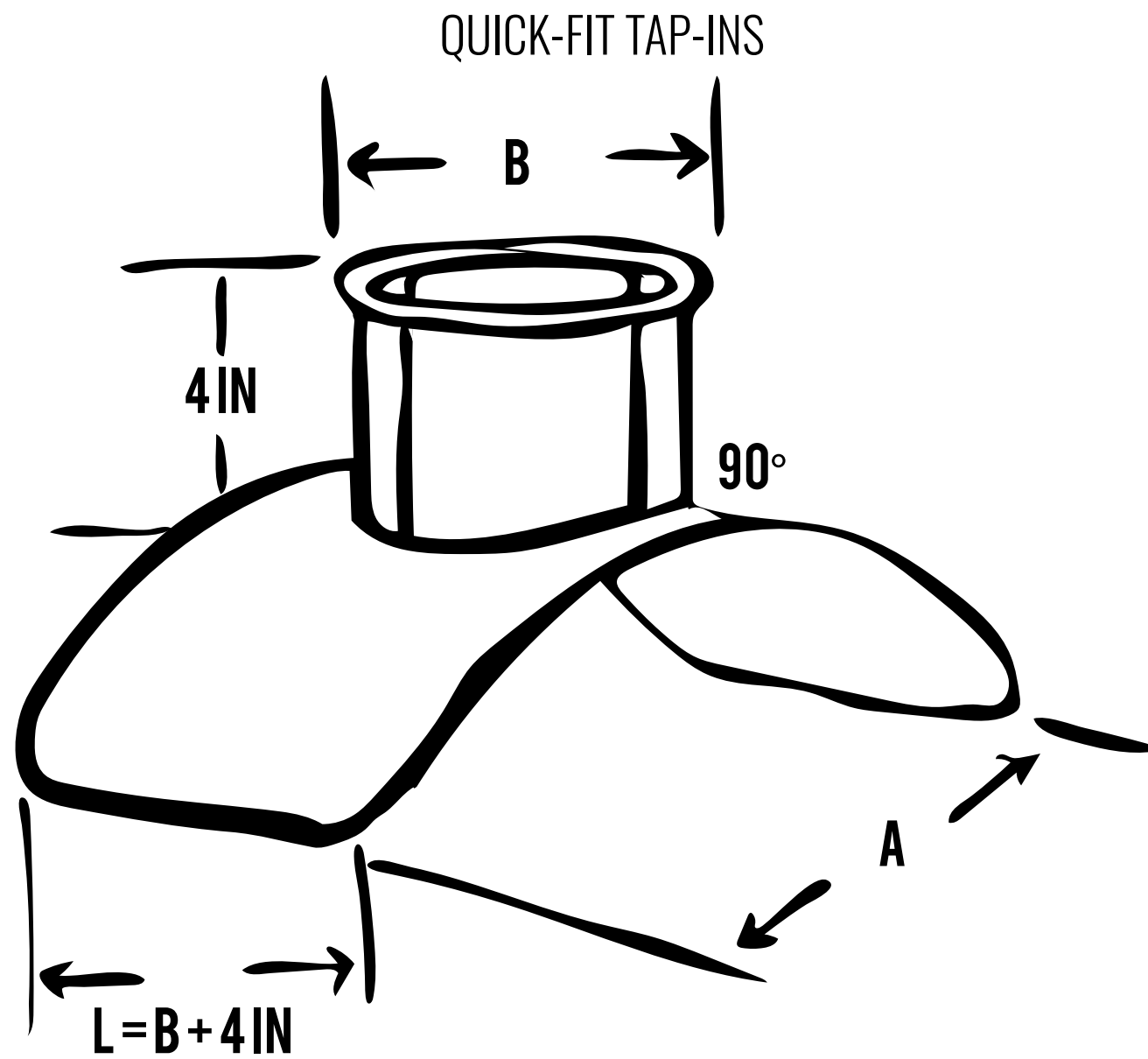

BRAND	PART #	DESCRIPTION	LINK
Nordfab	3224XX0610000	6in Galvanized Steel Tap-In	link
BRAND	PART #	DESCRIPTION	LINK
Nordfab	3224XX1810000	18in Galvanized Steel Tap-In	link
BRAND	PART #	DESCRIPTION	LINK
Nordfab	3224XX2010000	20in Galvanized Steel Tap-In	link

PLANT DUCTING

QUICK-FIT T-BRANCHES



BRAND	PART #	DESCRIPTION	LINK
Nordfab	8040304718	6in Galvanized Steel T-Branch	link
Liddell	900168505	6in Galvanized Steel T-Branch	link
BRAND	PART #	DESCRIPTION	LINK
Nordfab	8040305000	10in Galvanized Steel T-Branch	link
Liddell	900168506	10in Galvanized Steel T-Branch	link
BRAND	PART #	DESCRIPTION	LINK
Nordfab	8040304789	14in Galvanized Steel T-Branch	link
C&W	SNAP14890	14in Galvanized Steel T-Branch	link

PLANT DUCTING

QUICK-FIT MANUAL BLASTGATE

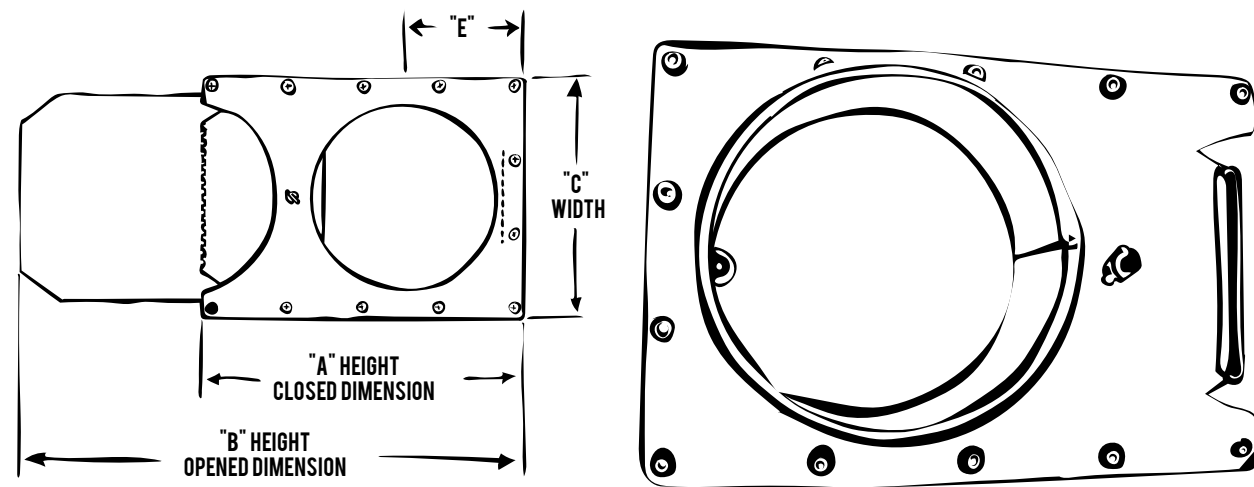

THUMBSCREW
1/4-20X3/4 IN

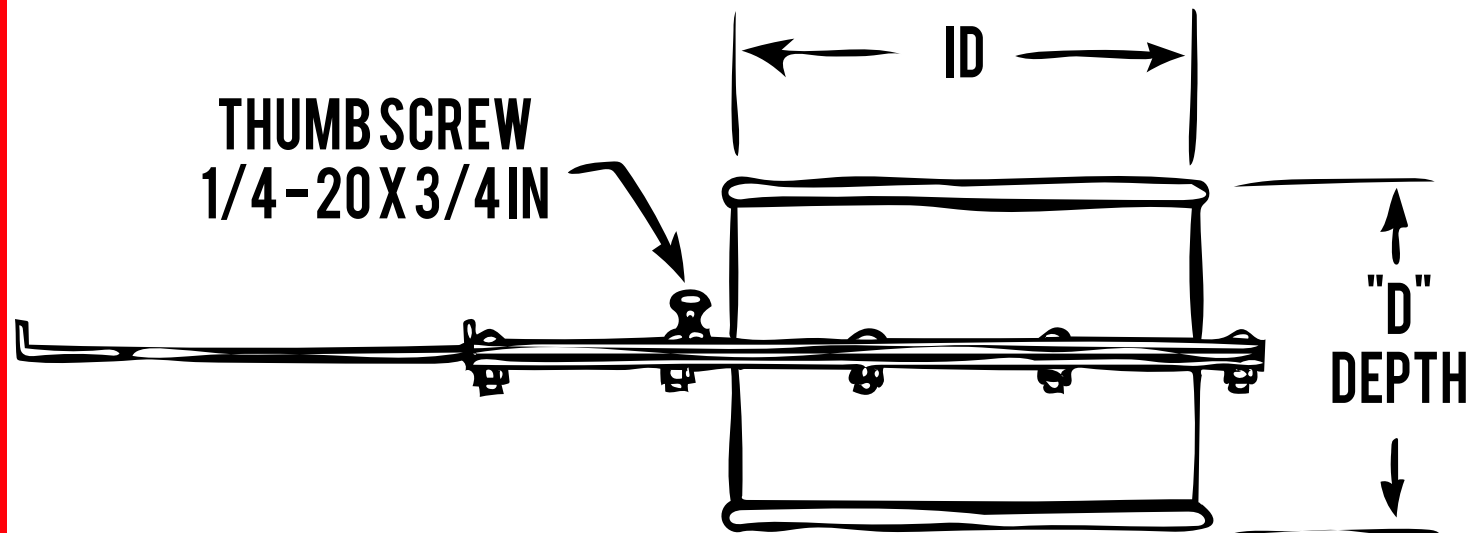

BRAND	PART #	DESCRIPTION	LINK
Nordfab	8010002306	8in Galvanized Steel Quick-Fit Manual Blastgate	link

PLANT DUCTING

QUICK-FIT ANGLE FLANGE ADAPTER

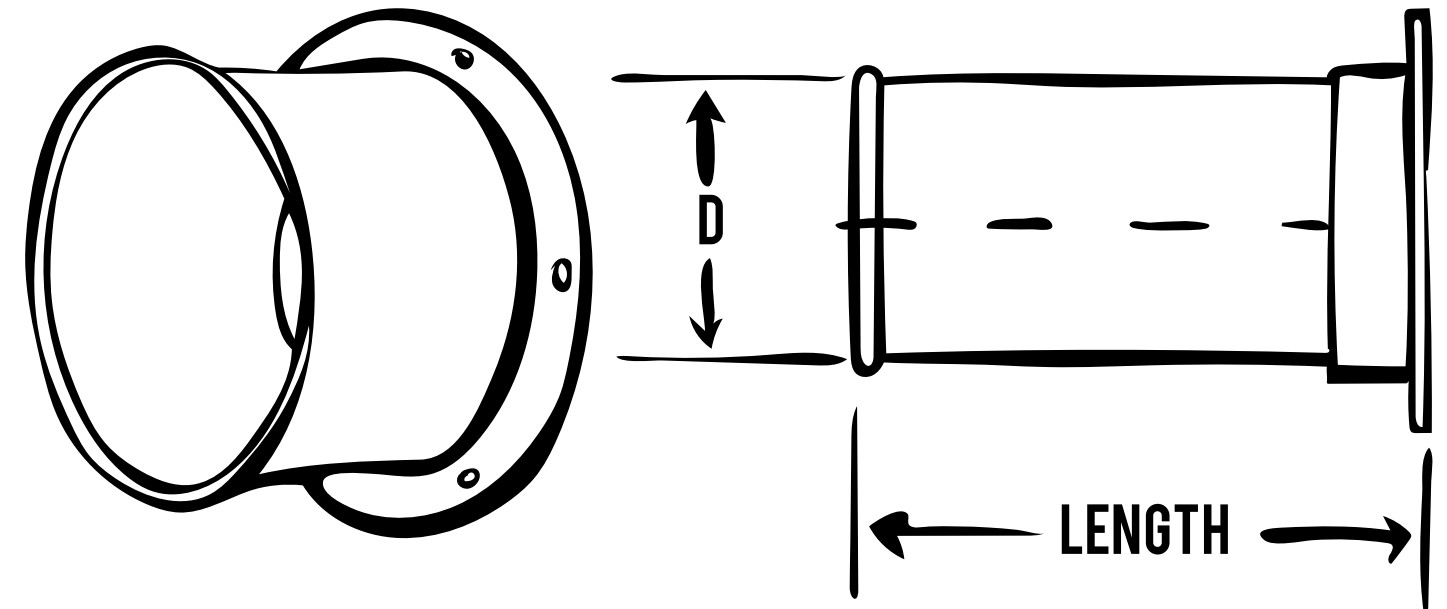

BRAND	PART #	DESCRIPTION	LINK
Nordfab	8040401828	12in Galvanized Steel Quick-Fit Angle Flange Adapter	link

GRIPPLE PIPE HANGERS

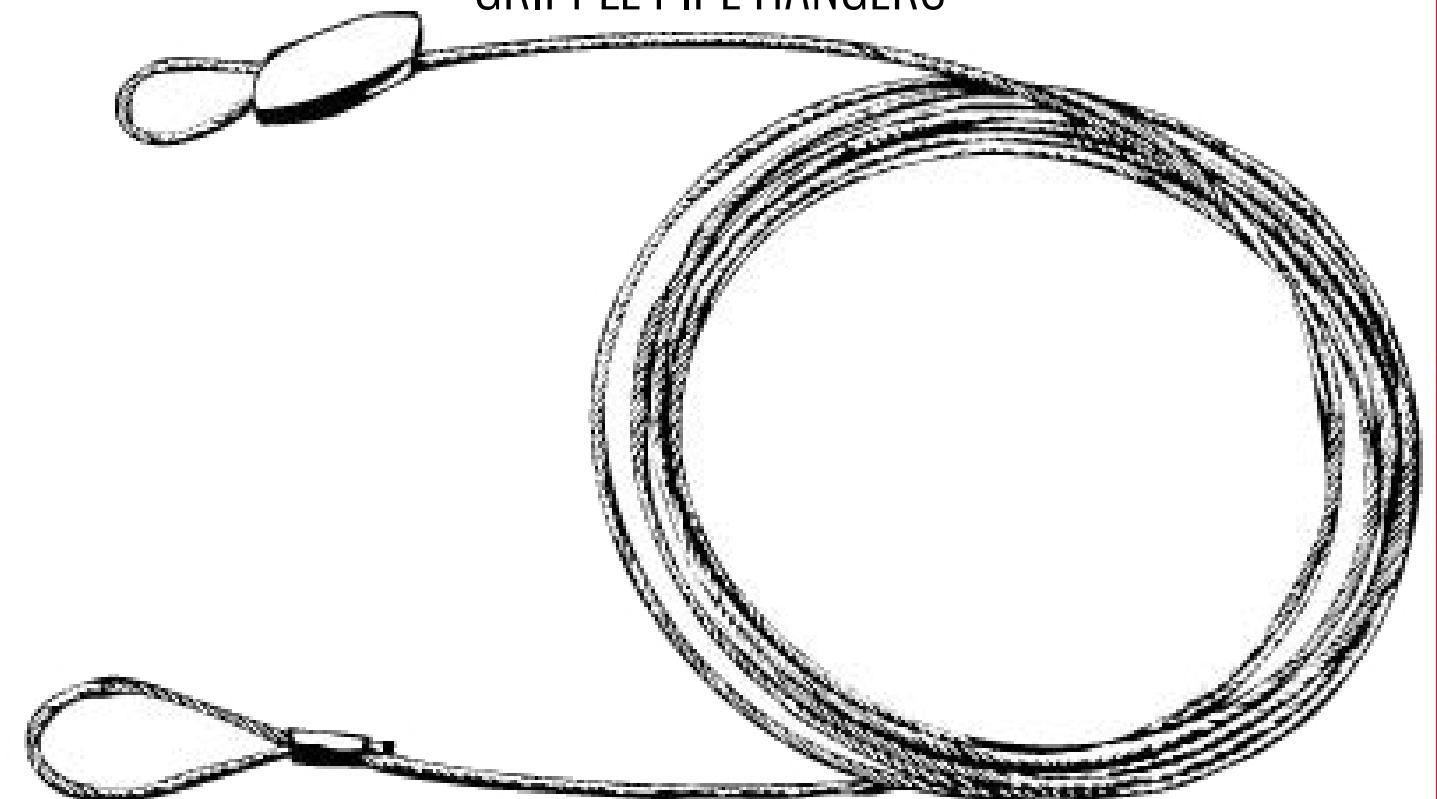

BRAND	PART #	DESCRIPTION	LINK
Nordfab	8010004091	15ft Galvanized Steel Grapple Pipe Hanger	link

PLANT DUCTING

QUICK-FIT DUCT CLAMP



BRAND	PART #	DESCRIPTION	LINK
Nordfab	8010005523	4in Galvanized Steel Quick-Fit Duct Clamp with Pin	link

BRAND	PART #	DESCRIPTION	LINK
Nordfab	8010005525	6in Galvanized Steel Quick-Fit Duct Clamp with Pin	link
Liddell	900166083	6in Galvanized Steel Quick-Fit Duct Clamp with Pin	link
C&W	SNAP06600	6in Galvanized Steel Quick-Fit Duct Clamp with Pin	link

BRAND	PART #	DESCRIPTION	LINK
Nordfab	8010005527	8in Galvanized Steel Quick-Fit Duct Clamp with Pin	link
Liddell	900166085	8in Galvanized Steel Quick-Fit Duct Clamp with Pin	link

PLANT DUCTING

QUICK-FIT DUCT CLAMP CONT.

BRAND	PART #	DESCRIPTION	LINK
Nordfab	8010005529	10in Galvanized Steel Quick-Fit Duct Clamp with Pin	link
C&W	SNAP10600	10in Galvanized Steel Quick-Fit Duct Clamp with Pin	link

BRAND	PART #	DESCRIPTION	LINK
Nordfab	8010005629	10in 304 Stainless Steel Quick-Fit Duct Clamp with Pin	link
Liddell	900166087	10in 304 Stainless Steel Quick-Fit Duct Clamp with Pin	link

BRAND	PART #	DESCRIPTION	LINK
Nordfab	8010005531	12in Galvanized Steel Quick-Fit Duct Clamp with Pin	link
Liddell	900166089	12in Galvanized Steel Quick-Fit Duct Clamp with Pin	link

BRAND	PART #	DESCRIPTION	LINK
Nordfab	8010005533	14in Galvanized Steel Quick-Fit Duct Clamp with Pin	link
C&W	SNAP14600	14in Galvanized Steel Quick-Fit Duct Clamp with Pin	link

BRAND	PART #	DESCRIPTION	LINK
Nordfab	8010005633	14in 304 Stainless Steel Quick-Fit Duct Clamp with Pin	link
Liddell	900166091	14in 304 Stainless Steel Quick-Fit Duct Clamp with Pin	link

BRAND	PART #	DESCRIPTION	LINK
Nordfab	8010005535	16in Galvanized Steel Quick-Fit Duct Clamp with Pin	link

BRAND	PART #	DESCRIPTION	LINK
Nordfab	8010005537	18in Galvanized Steel Quick-Fit Duct Clamp with Pin	link

PLANT DUCTING

RUBBER HOSE

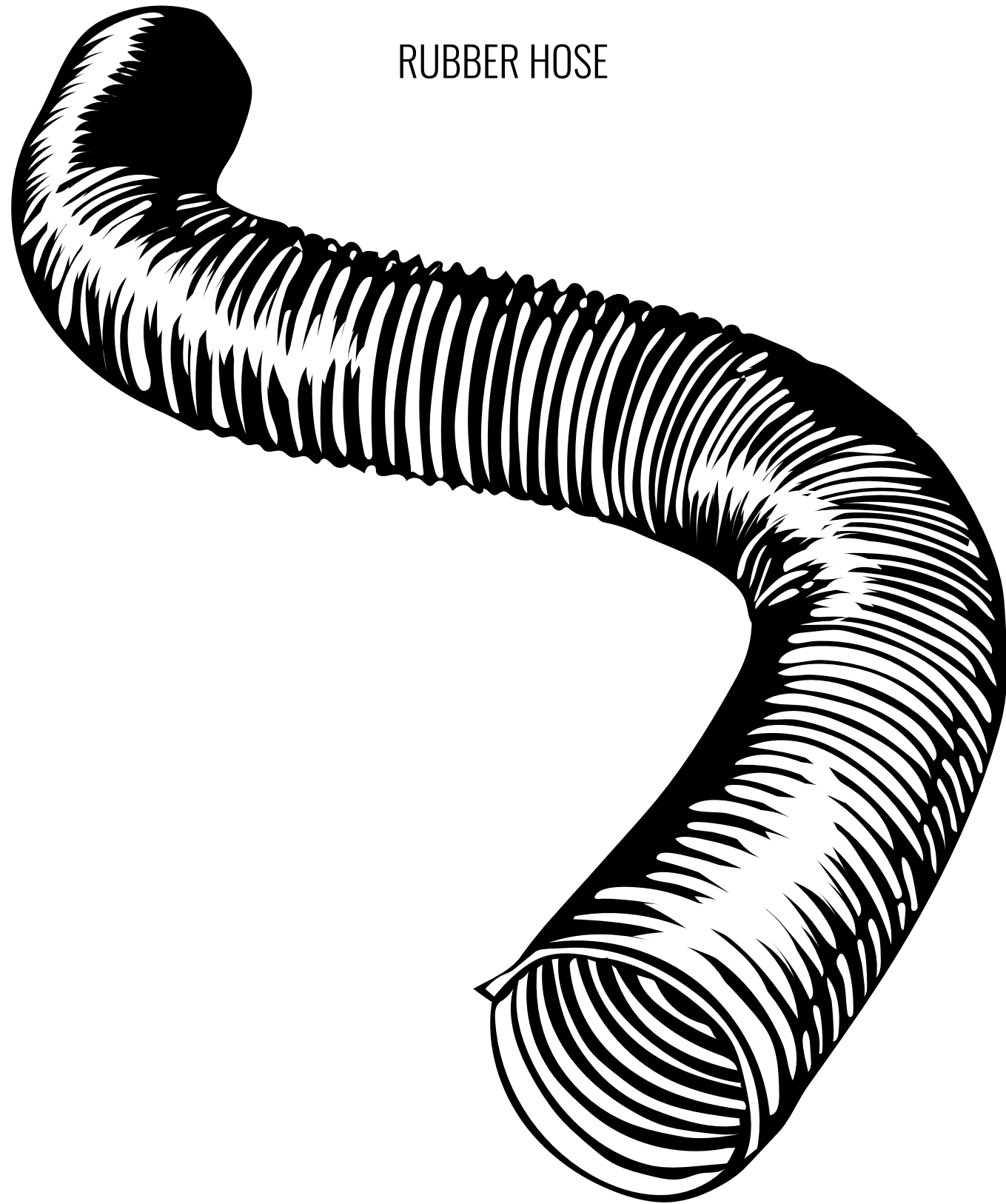

BRAND	PART #	DESCRIPTION	LINK
Nordfab	8010004853	18in Flexible Black Rubber Hose with Steel Coil	link

PLANT DUCTING

HOSE CLAMP



BRAND	PART #	DESCRIPTION	LINK
Nordfab	8010004419	6in 304 Stainless Steel Hose Clamp	link
BRAND	PART #	DESCRIPTION	LINK
Nordfab	8010004407	10in 304 Stainless Steel Hose Clamp	link

QUICK-FIT HOSE ADAPTER



QUICK-FIT HOSE ADAPTER CONT.

BRAND	PART #	DESCRIPTION	LINK
Nordfab	8040401964	4in Galvanized Steel Quick-Fit Hose Adapter	link

BRAND	PART #	DESCRIPTION	LINK
Nordfab	8040401966	6in Galvanized Steel Quick-Fit Hose Adapter	link

BRAND	PART #	DESCRIPTION	LINK
Nordfab	8040401968	8in Galvanized Steel Quick-Fit Hose Adapter	link

BRAND	PART #	DESCRIPTION	LINK
Nordfab	8040401970	10in Galvanized Steel Quick-Fit Hose Adapter	link

BRAND	PART #	DESCRIPTION	LINK
Nordfab	8040401972	12in Galvanized Steel Quick-Fit Hose Adapter	link

BRAND	PART #	DESCRIPTION	LINK
Nordfab	8040401974	14in Galvanized Steel Quick-Fit Hose Adapter	link

BRAND	PART #	DESCRIPTION	LINK
Nordfab	8040401978	18in Galvanized Steel Quick-Fit Hose Adapter	link

PLANT DUCTING

END CAPS



BRAND	PART #	DESCRIPTION	LINK
Nordfab	8010003774	6in Galvanized Steel End Cap	link
Liddell	900168991	6in Galvanized Steel End Cap	link

BRAND	PART #	DESCRIPTION	LINK
Nordfab	8010003758	14in Galvanized Steel Duct Pipe End Cap	link
C&W	SNAP14520	14in Galvanized Steel Duct Pipe End Cap	link



QUICK-FIT ADJUSTABLE NIPPLES

BRAND	PART #	DESCRIPTION	LINK
Nordfab	8040207306	10in Snap Duct Pipe Adjusting Nipple With O-Ring	link
C&W	SNAP10100	10in Snap Duct Pipe Adjusting Nipple With O-Ring	link

PLANT DUCTING

SNAP DUCT PIPE HANGERS



BRAND	PART #	DESCRIPTION	LINK
Nordfab	8010004259	6in Snap Duct Pipe Hanger	link
C&W	SNAP06710	6in Snap Duct Pipe Hanger	link

BRAND	PART #	DESCRIPTION	LINK
Nordfab	8010004263	8in Snap Duct Pipe Hanger	link
C&W	SNAP08710	8in Snap Duct Pipe Hanger	link

BRAND	PART #	DESCRIPTION	LINK
Nordfab	8010004214	10in Snap Duct Pipe Hanger	link
C&W	SNAP10750	10in Snap Duct Pipe Hanger	link

BRAND	PART #	DESCRIPTION	LINK
Nordfab	8010004222	14in Snap Duct Pipe Hanger	link
C&W	SNAP14710	14in Snap Duct Pipe Hanger	link

PLANT DUCTING

QUICK-FIT MACHINE ADAPTER



BRAND	PART #	DESCRIPTION	LINK
Nordfab	8040401694	12in Galvanized Steel Quick-Fit Machine Adapter	link

QUICK-FIT ANGLE FLANGE ADAPTER



BRAND	PART #	DESCRIPTION	LINK
Nordfab	8040401830	14in Galvanized Steel Quick-Fit Angle Flange Adapter	link

PLANT DUCTING

GALVANIZED QUICK-FIT DUCTS FOR VENTS & SILOS



BRAND	PART #	DESCRIPTION	LINK
Stephens	32101690	20 Gauge 90 Degree Elbow with a 16in Diameter	link



BRAND	PART #	DESCRIPTION	LINK
Stephens	32000600	6in Diameter x 5ft Long Quick-Fit Pipe	link
C&W	SNAP06000	6in Diameter x 5ft Long Quick-Fit Pipe	link



BRAND	PART #	DESCRIPTION	LINK
Stephens	32000800	8in Diameter x 59.06in Long Galvanized Steel Quick-Fit Pipe	link

PLANT DUCTING

GALVANIZED QUICK-FIT DUCTS FOR VENTS & SILOS



BRAND	PART #	DESCRIPTION	LINK
Stephens	32100690	6in 90 Degree Galvanized Steel Elbow - High Pressure Duct	link
Stephens	32100890	8in 90 Degree Galvanized Steel Elbow - High Pressure Duct	link

PLANT DUCTING

SPIRAL DUCT FITTING



BRAND	PART #	DESCRIPTION	LINK
C&W	SP012	10in 45 Degree Spiral Duct Pipe Elbow	link

PLANT DUCTING

General Purpose RFH durable thermoplastic rubber flexible hose reinforced with wire helix. RFH can be used in numerous applications with excellent results such as oil mist collection. It truly is a general-purpose duct. Some of the uses are light duty dust collection & fume removal. RFH has superior chemical resistance, good abrasion resistance, UV/ozone resistant.

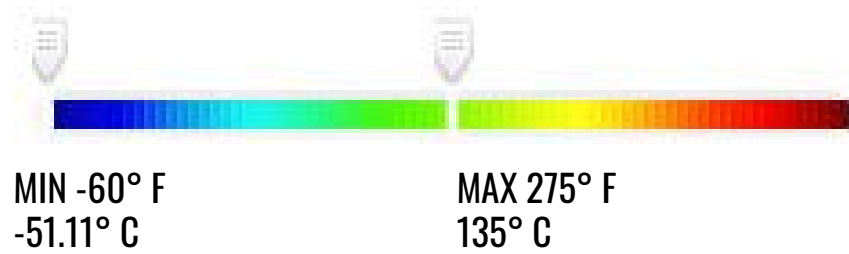

Can be used with a variety of coupling options (not included)

- Most versatile general purpose hose available today
- No cements, glues or adhesives are used in the manufacturing process
- Can handle applications with a wide temperature range
- Superior chemical resistance
- Good abrasion resistance
- Available in metric diameters
- Available with cuffed end finishes
- Available up to 100' lengths



APPLICATIONS:

Air • Chemical Fumes • Chips / Debris / Granules • Dust • Exhaust + Ventilation • General Purpose • Material Handling • Moisture / Hydraulic • Temperature Extremes • Vacuum + Suction

PLANT DUCTING



STEPHENS	CON-E-CO	MCNEILUS	VINCE HAGAN	DIAMETER	WORKING PRESSURE (PSI)	VACUUM (INHG)	CL BEND RADIUS (IN)
CWC4	--	1236909	083768	4in	10	25	6.50
CWC6	--	--	081495	6in	8	11.5	8.75
--	143710	1236912	--	7in	--	--	--
CWC8	143711	1236913	081496	8in	6	5.5	12
CWC10	143712	1236914	081497	10in	4	5	12.50
CWC12	143713	1236915	081498	12in	4	4	13.75
CWC14	143714	1236916	081499	14in	2	2	18.00
CWC16	143715	1236917	083769	16in	2	2	21.00
CWC18	143717	1236919	083770	18in	2	2	21.50
--	143716	1236918	--	20in	--	--	--

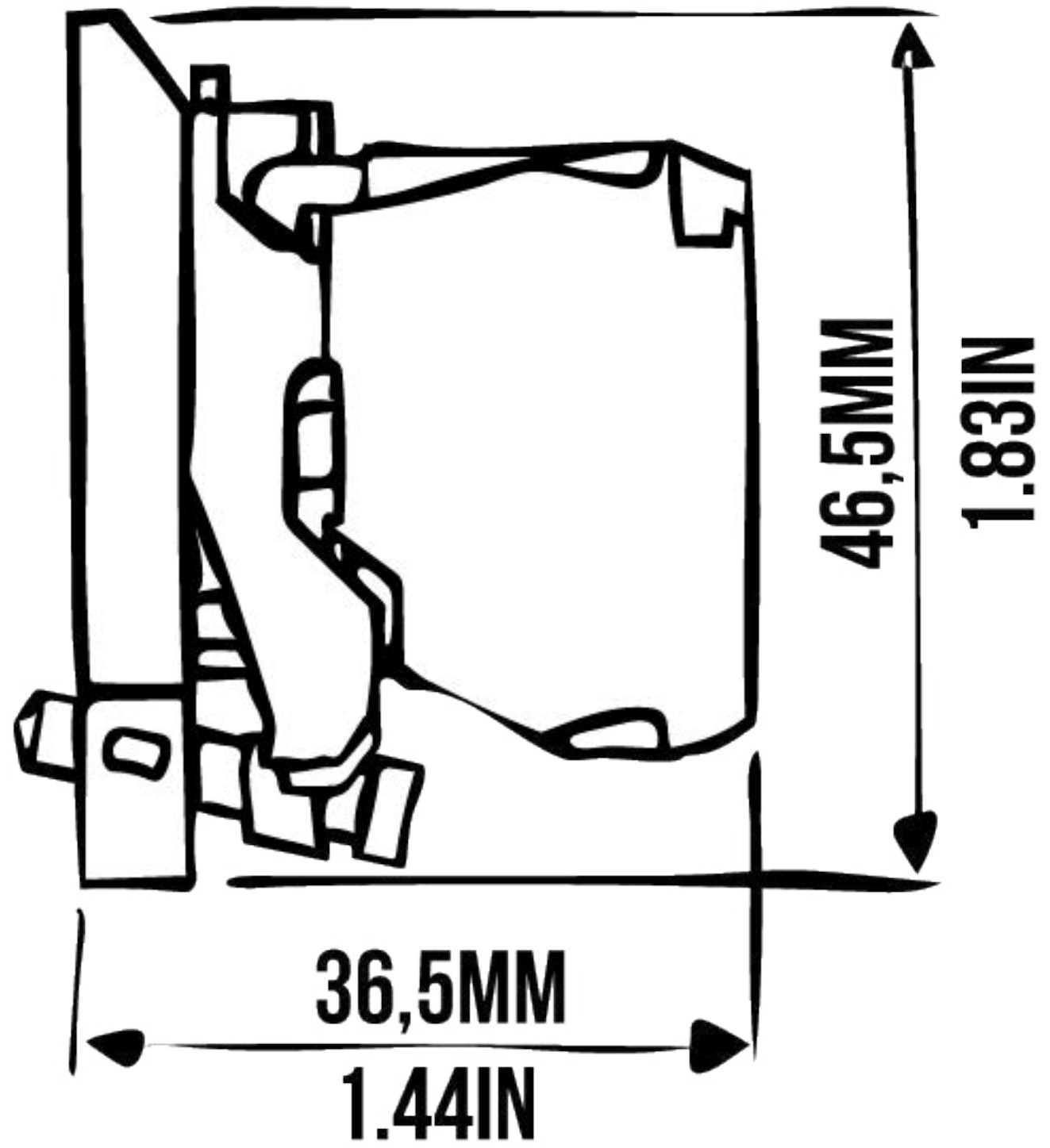

BRAND	PART #	DESCRIPTION	LINK
Stephens	ZB4BZ101	Normally Open Contact Block with Flange	link
Stephens	ZB4BZ102	Normally Closed Contact Block with Flange	link



ZB4BW33

BRAND	PART #	DESCRIPTION	LINK
Stephens	ZB4BW33	Green Illuminated Push Button	link
Stephens	ZB4BW34	Red Illuminated Push Button	link

BRAND	PART #	DESCRIPTION	LINK
Stephens	ZB4BWOG31	Green Indicator Pushbutton Switch	link

ZB4BWOG31

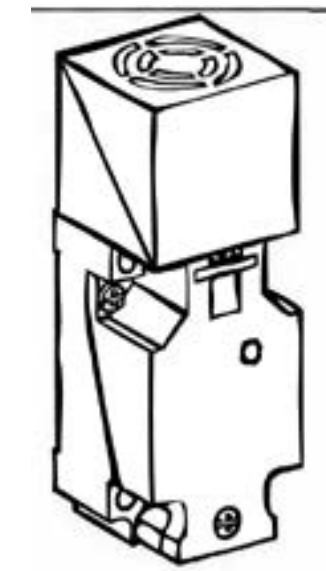

XS8C40FP260H7

BRAND	PART #	DESCRIPTION	LINK
Stephens	XS8C40FP260H7	Telemecanique Proximity Switch Sensor	link

BRAND	PART #	DESCRIPTION	LINK
Stephens	ZB4BW35	Amber Illuminated Push Button	link

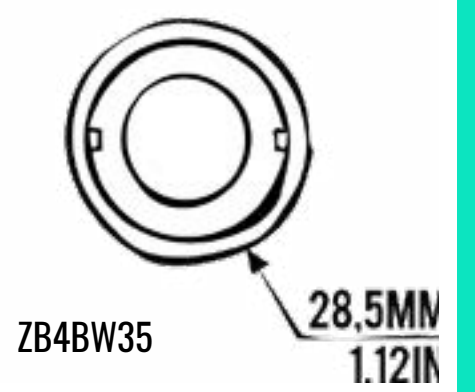
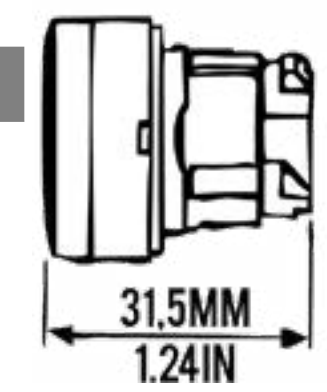

ELECTRICAL COMPONENTS

9007MA18



BRAND	PART #	DESCRIPTION	LINK
Stephens	9007MA18	Limit Switch	link

9007C54B2



BRAND	PART #	DESCRIPTION	LINK
Stephens	9007C54B2	Square D Limit Switch	link

9007MA18



BRAND	PART #	DESCRIPTION	LINK
Stephens	9007MA18	Limit Switch	link

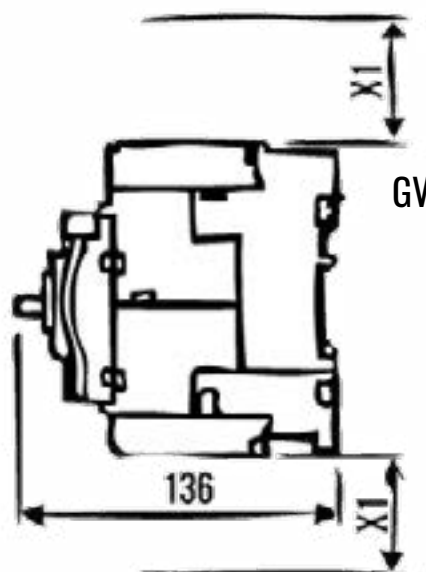

GV3P50

BRAND	PART #	DESCRIPTION	LINK
Stephens	GV3P50	600V 37-50A Manual Starter	link

ELECTRICAL COMPONENTS

LC1D40AG7

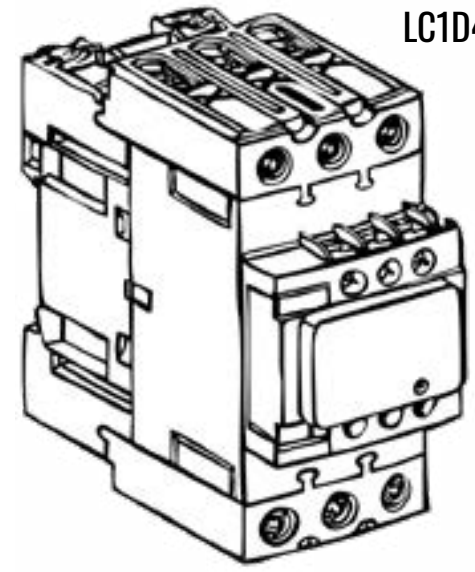

BRAND	PART #	DESCRIPTION	LINK
Stephens	LC1D40AG7	Contacteur Control	link

02107182



BRAND	PART #	DESCRIPTION	LINK
Besser	02107182	Limit Switch	link

0162000012



BRAND	PART #	DESCRIPTION	LINK
Besser	0162000012	Heavy Duty Limit Switch	link

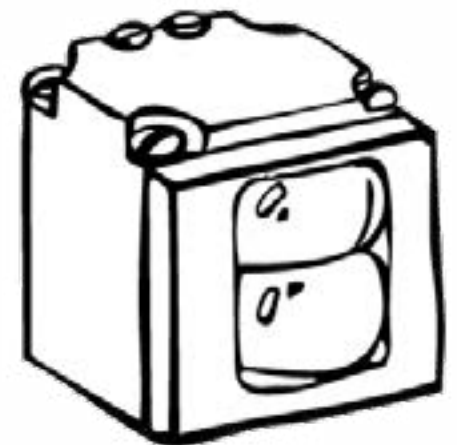
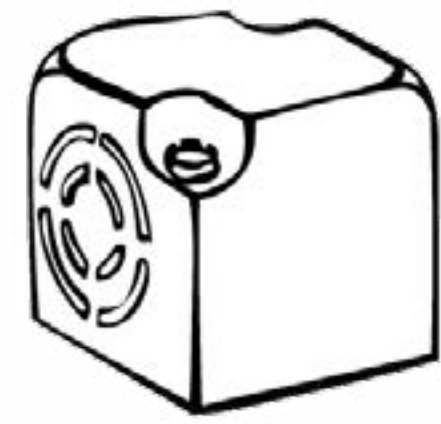
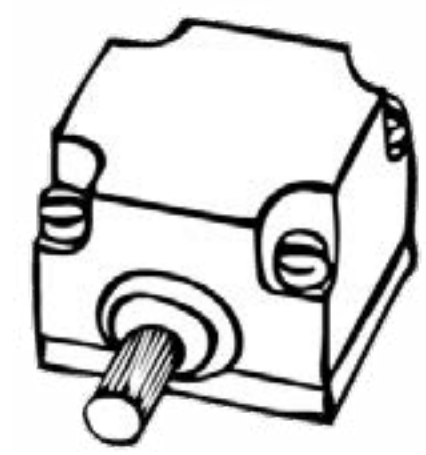

BRAND	PART #	DESCRIPTION	LINK
Besser	0162000022	Limit Switch Head	link

ELECTRICAL COMPONENTS

ET000

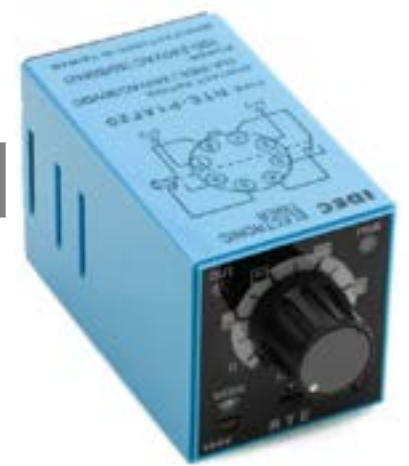

BRAND	PART #	DESCRIPTION	LINK
C&W	ET000	Timer Relay for AntiOverfill System Control Panel	link

ET001



BRAND	PART #	DESCRIPTION	LINK
C&W	ET001	Dust Collector Jet Pulse Timer Board	link

ET025



BRAND	PART #	DESCRIPTION	LINK
C&W	ET025	4 Pole Digital Timer Board	link

ET026



BRAND	PART #	DESCRIPTION	LINK
C&W	ET026	6 Pole Digital Timer Board	link

ELECTRICAL COMPONENTS

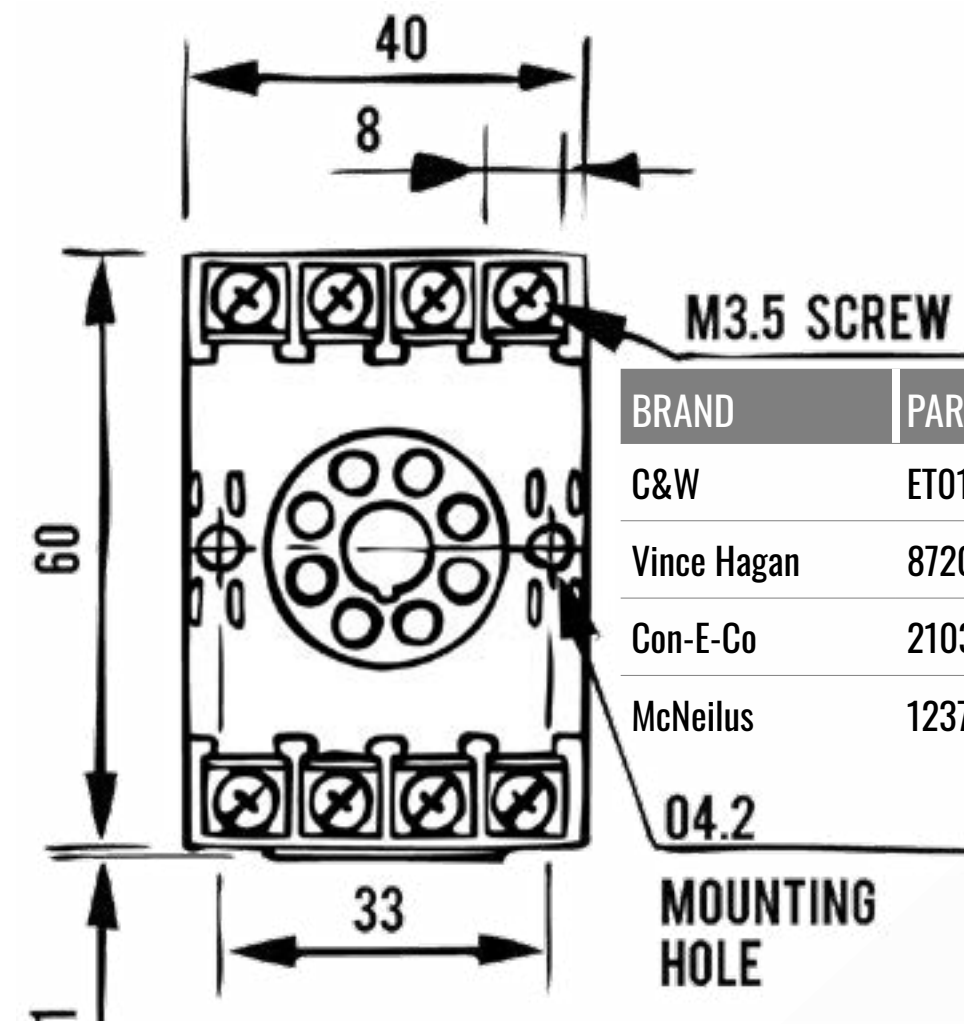

BRAND	PART #	DESCRIPTION	LINK
C&W	ET012	Socket	link
Vince Hagan	87203	Socket	link
Con-E-Co	210310	Socket	link
McNeilus	1237370	Socket	link

BRAND	PART #	DESCRIPTION	LINK
C&W	SS130	Overfill Control Panel and High Level Alarm	link



CT006



BRAND	PART #	DESCRIPTION	LINK
C&W	CT006	Overfill Control Panel and High/Low Level Alarm	link

ELECTRICAL COMPONENTS



S0010



S0026

BRAND	PART #	DESCRIPTION	LINK
C&W	S0026	.75in Turbo Solenoid Valve	link
C&W	S0002	1in Jet Pulse Diaphragm Valve	link
C&W	S0010	1.5in Jet Pulse Diaphragm Valve	link

S0014



BRAND	PART #	DESCRIPTION	LINK
C&W	S0014	Double Bulkhead Compression Coupler	link



S0008

BRAND	PART #	DESCRIPTION	LINK
C&W	S0008	.75in Solenoid Valve - Threaded	link

S0045



BRAND	PART #	DESCRIPTION	LINK
C&W	S0045	.25in Solenoid Valve	link

ELECTRICAL COMPONENTS

BRAND	PART #	DESCRIPTION	LINK
C&W	S0033	Solenoid Coil with DIN Connector for Jet Pulse Collectors	link



S0033



EW015

BRAND	PART #	DESCRIPTION	LINK
C&W	EW015	3ft Chord & Grip	link

S0048



BRAND	PART #	DESCRIPTION	LINK
C&W	S0048	1in Threaded Solenoid Valve	link



280899

BRAND	PART #	DESCRIPTION	LINK
Con-E-Co	280899	Proximity Switch	link

0111070



BRAND	PART #	DESCRIPTION	LINK
Con-E-Co	0111070	Batch Plant Proximity Sensor Normally Closed	link

ELECTRICAL COMPONENTS

BRAND	PART #	DESCRIPTION	LINK
-------	--------	-------------	------

Con-E-Co 0117042 Aggregate Bin Turnhead Proximity Sensor [link](#)



BRAND	PART #	DESCRIPTION	LINK
-------	--------	-------------	------

Con-E-Co 0111066 Normally Open Proximity Switch [link](#)

BRAND	PART #	DESCRIPTION	LINK
-------	--------	-------------	------

Con-E-Co 0143633 Vane Actuator Proximity Switch Bracket [link](#)

no image



BRAND	PART #	DESCRIPTION	LINK
-------	--------	-------------	------

Con-E-Co 0142908 Pointer For Vane [link](#)

BRAND	PART #	DESCRIPTION	LINK
-------	--------	-------------	------

Con-E-Co 1140725 Proximity Switch Bracket for Bray Butterfly Valve Actuators [link](#)



ELECTRICAL COMPONENTS

BRAND	PART #	DESCRIPTION	LINK
-------	--------	-------------	------

Con-E-Co 280700 Omron Limit Switch [link](#)



BRAND	PART #	DESCRIPTION	LINK
-------	--------	-------------	------

Con-E-Co 280620 Limit Switch Arm Lever [link](#)

BRAND	PART #	DESCRIPTION	LINK
-------	--------	-------------	------

Con-E-Co 1257595 Bray Limit Switch With Mounting Kit [link](#)

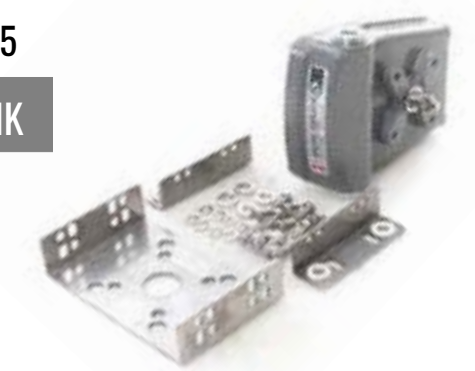

BRAND	PART #	DESCRIPTION	LINK
-------	--------	-------------	------

Con-E-Co 1142273 Limit Switch Bracket for Bray Butterfly Valve Actuators [link](#)

BRAND	PART #	DESCRIPTION	LINK
-------	--------	-------------	------

Con-E-Co 0111204 Float Switch [link](#)



ELECTRICAL COMPONENTS

BRAND	PART #	DESCRIPTION	LINK
Con-E-Co	145163	120 Volt 4 Amp Reed Switch with 30ft Cord	link



1468028

BRAND	PART #	DESCRIPTION	LINK
Con-E-Co	1468028	24 VDC Plant Relay	link

BRAND	PART #	DESCRIPTION	LINK
Con-E-Co	1483886	Analog Timer for Dust Collectors	link

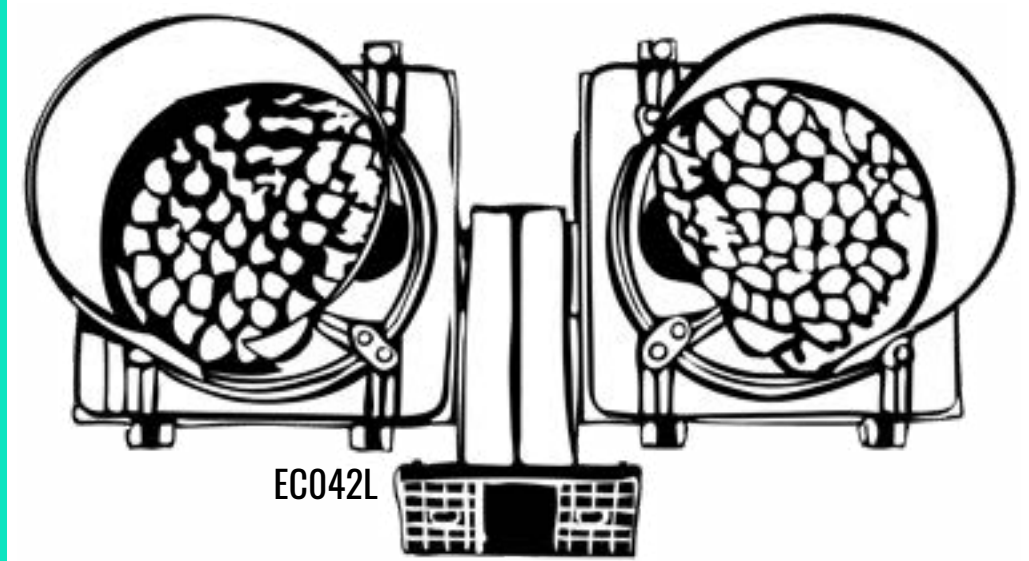

BRAND	PART #	DESCRIPTION	LINK
Con-E-Co	EC042L	LED Light Bar Assembly with 50ft Cord	link

no image

BRAND	PART #
Con-E-Co	210310

DESCRIPTION	LINK
2 Row Timer Base Socket	link

ELECTRICAL COMPONENTS

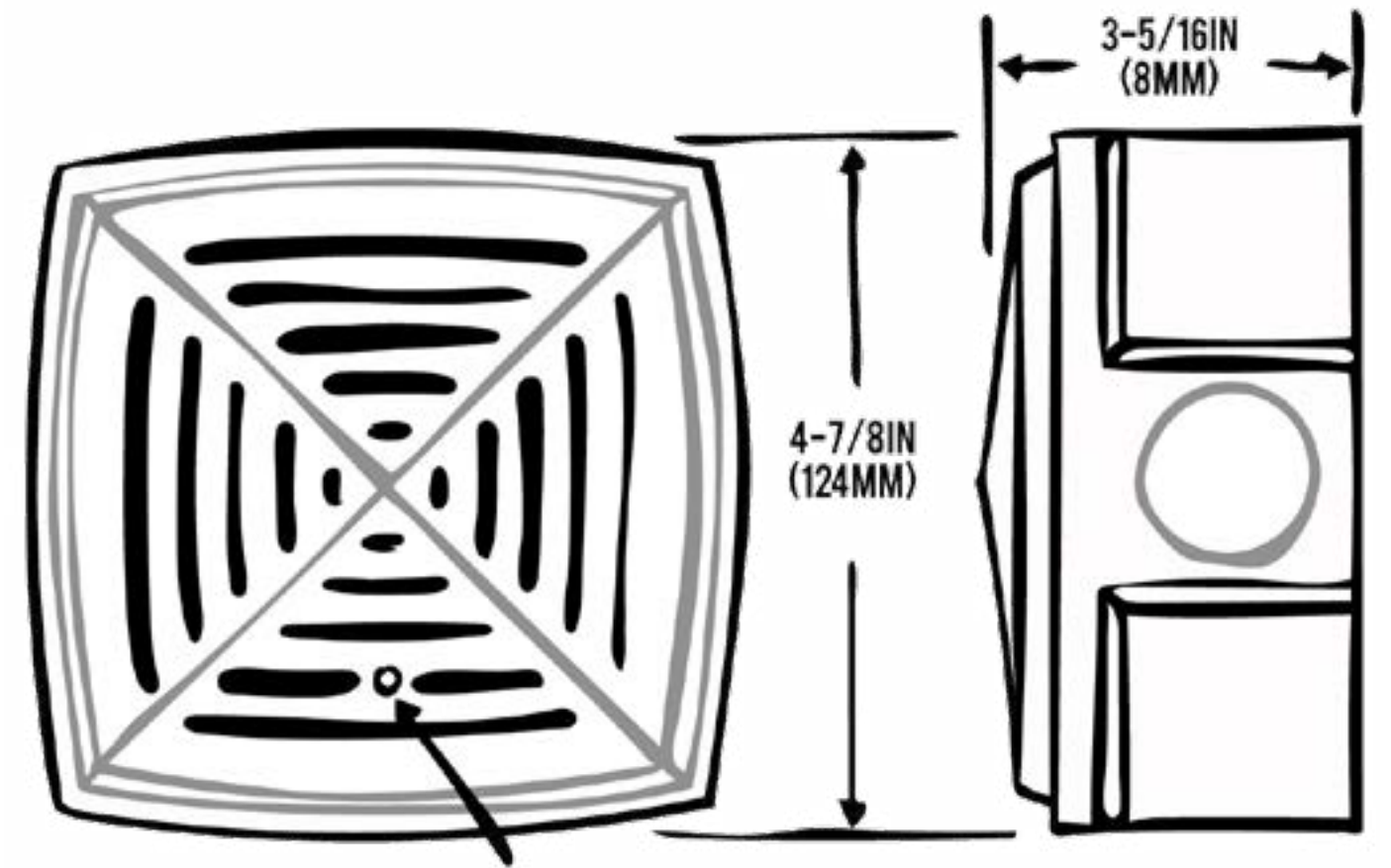

BRAND	PART #	DESCRIPTION	LINK
Con-E-Co	114200	Concrete Plant Solo Overfill Warning Alarm Horn	link
McNeilus	1236843	Concrete Plant Solo Overfill Warning Alarm Horn	link



BRAND	PART #	DESCRIPTION	LINK
Erie Strayer	59118	Interface Card - Opto 22	link

BRAND	PART #	DESCRIPTION	LINK
Erie Strayer	AD432301A	Digital Indicator	link



ELECTRICAL COMPONENTS

BRAND	PART #	DESCRIPTION	LINK
-------	--------	-------------	------

Erie Strayer 51621 Heavy Duty Double Pole Limit Switch [link](#)



51621



24682

BRAND	PART #	DESCRIPTION	LINK
-------	--------	-------------	------

Erie Strayer 24682 Adjustable Limit Switch Arm Lever [link](#)

BRAND	PART #	DESCRIPTION	LINK
-------	--------	-------------	------

Liddell R07000067 Horn/Light Assembly [link](#)



R07000067



900172003

BRAND	PART #	DESCRIPTION	LINK
-------	--------	-------------	------

Liddell 900172003 AFU Safety Switch Single [link](#)

BRAND	PART #	DESCRIPTION	LINK
-------	--------	-------------	------

Liddell 900155001 Contact Block [link](#)



900155001

BRAND	PART #	DESCRIPTION	LINK
-------	--------	-------------	------

Liddell 900153001 2 Position 60 Degree Selector Switch [link](#)

900153001

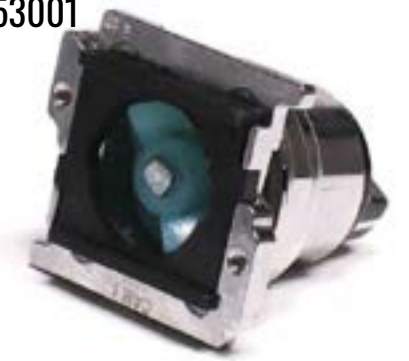

740111066

BRAND	PART #	DESCRIPTION	LINK
-------	--------	-------------	------

McNeilus 740111066 Normally Open Batch Plant Proximity Sensor [link](#)

BRAND	PART #	DESCRIPTION	LINK
-------	--------	-------------	------

McNeilus 740111070 Normally Closed Proximity Sensor [link](#)

740111070



740143633A

BRAND	PART #	DESCRIPTION	LINK
-------	--------	-------------	------

no image

McNeilus 740143633A Bracket, Vane Actuator Proximity Switch [link](#)

BRAND	PART #	DESCRIPTION	LINK
-------	--------	-------------	------

McNeilus 1144757 SPDT Relay [link](#)

1144757



ELECTRICAL COMPONENTS

BRAND	PART #	DESCRIPTION	LINK
McNeilus	0111519	Concrete Plant Proximity Sensor Switch	link



1103658

BRAND	PART #	DESCRIPTION	LINK
McNeilus	1103658	Concrete Plant Silo Antioverfill Warning Horn	link

2980601217

BRAND	PART #	DESCRIPTION	LINK
Rexcon	2980601217	Contact Block	link



2980622317

BRAND	PART #	DESCRIPTION	LINK
Rexcon	2980622317	Push Button 1 Pole Momentary Switch	link

BRAND	PART #	DESCRIPTION	LINK
Rexcon	2120211101	Solenoid Coil	link



ELECTRICAL COMPONENTS

BRAND	PART #	DESCRIPTION	LINK
Rexcon	2120010517	Float Switch SPST 100VA	link

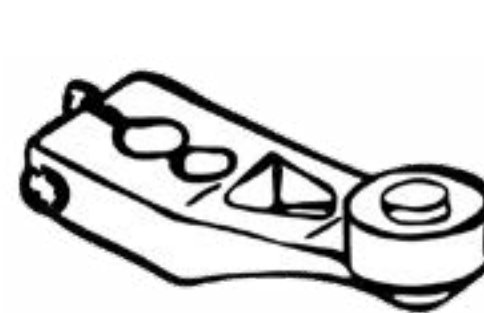

2120002917

BRAND	PART #	DESCRIPTION	LINK
Rexcon	2120002917	Lever	link
Vince Hagan	101804	Lever	link

2980656817

BRAND	PART #	DESCRIPTION	LINK
Rexcon	2980656817	Heavy Duty Double Pole Limit Switch	link



SOLDER TERMINALS

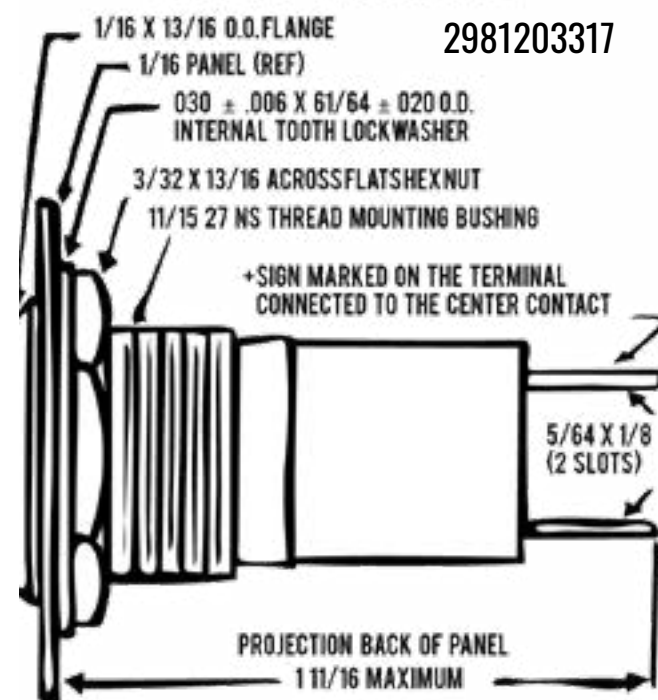

BRAND	PART #	DESCRIPTION	LINK
Rexcon	2981203317	Indicator Light Socket	link

ELECTRICAL COMPONENTS

BRAND	PART #	DESCRIPTION	LINK
-------	--------	-------------	------

Rexcon 2980013817 Vibratone Horn [link](#)

2980013817



201512517

BRAND	PART #	DESCRIPTION	LINK
-------	--------	-------------	------

Rexcon 201512517 Input Valve Relay [link](#)

BRAND	PART #	DESCRIPTION	LINK
-------	--------	-------------	------

Rexcon ET000 Timer Relay [link](#)

ET000



ET001

BRAND	PART #	DESCRIPTION	LINK
-------	--------	-------------	------

Rexcon ET001 Jet Pulse Timer Board [link](#)

BRAND	PART #	DESCRIPTION	LINK
-------	--------	-------------	------

Johnson-Ross 5576545 Proximity Switch Sensor [link](#)

5576545



ELECTRICAL COMPONENTS

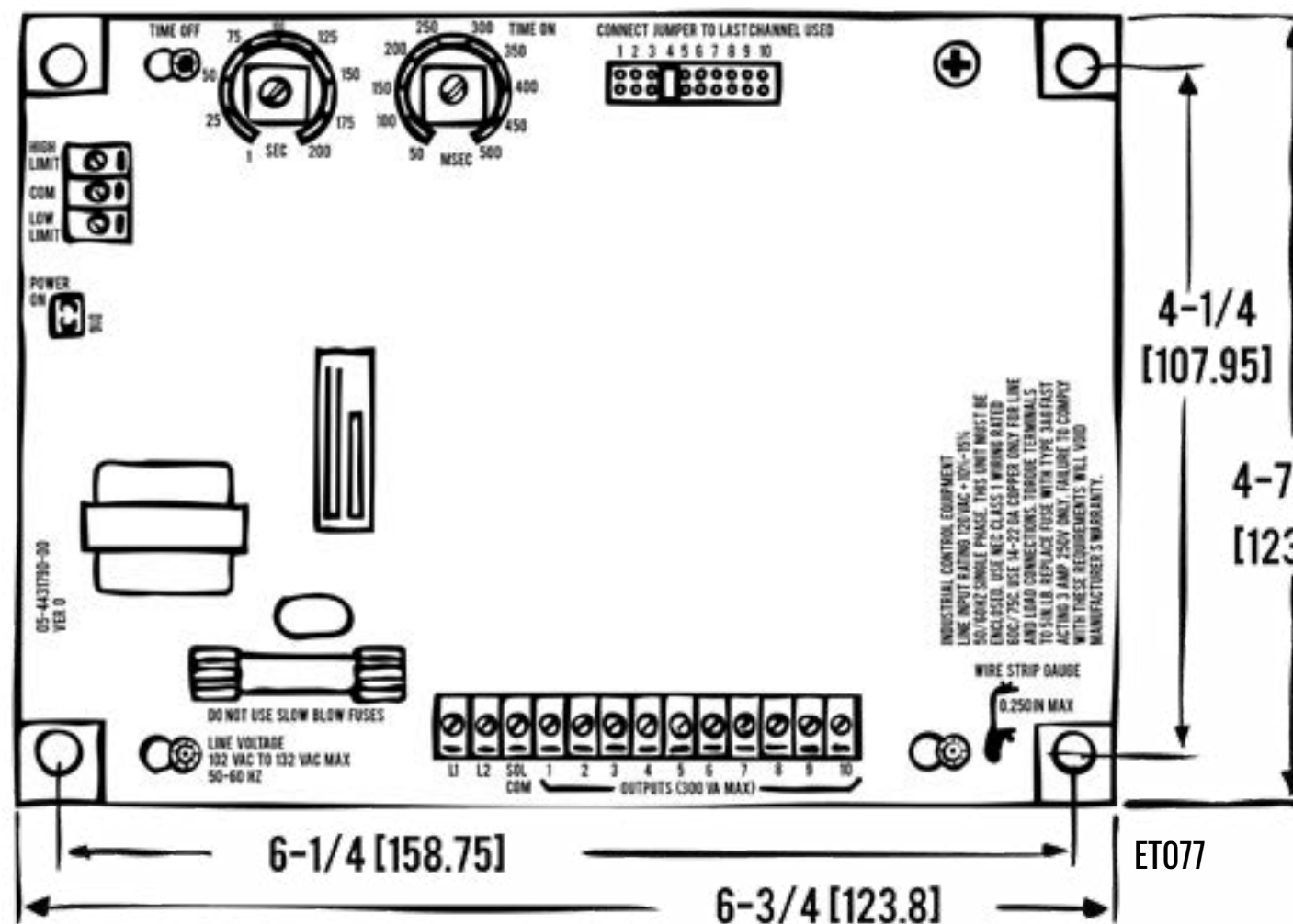

BRAND	PART #	DESCRIPTION	LINK
-------	--------	-------------	------

Rexcon ET077 Timer Circuit Board [link](#)

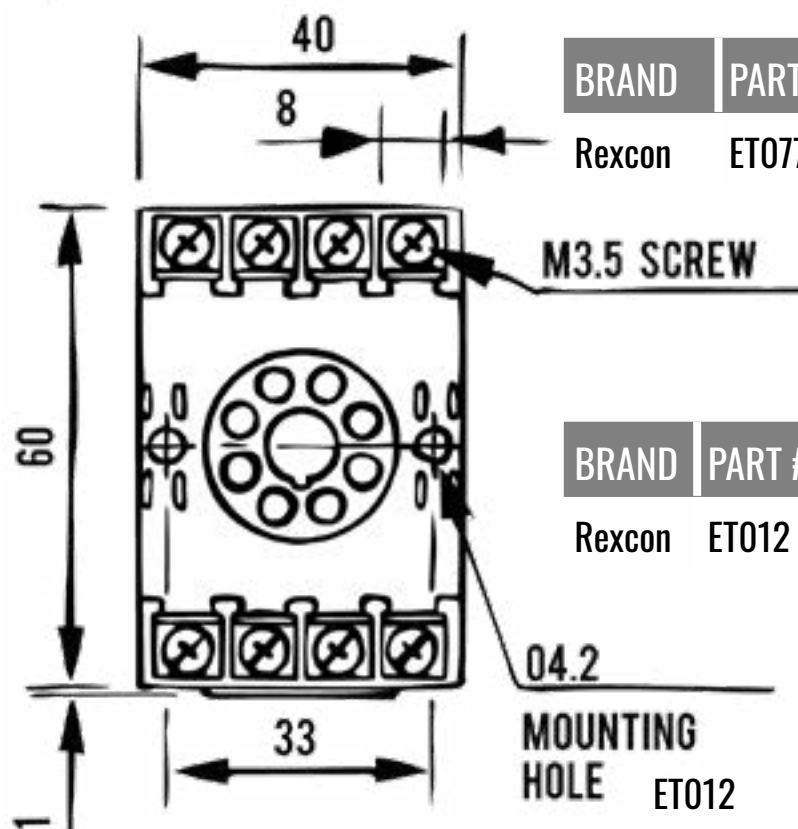

BRAND	PART #	DESCRIPTION	LINK
-------	--------	-------------	------

Rexcon ET012 8-Pin Socket [link](#)

ELECTRICAL COMPONENTS

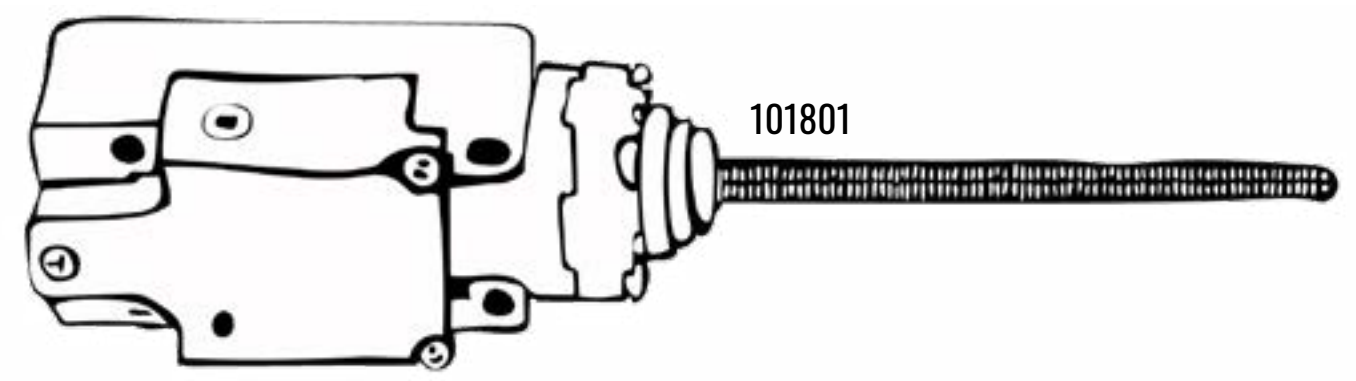

BRAND	PART #	DESCRIPTION	LINK
Vince Hagan	101801	Limit Switch	link



101802

BRAND	PART #	DESCRIPTION	LINK
Vince Hagan	101802	Heavy Duty Double Pole Limit Switch	link

BRAND	PART #	DESCRIPTION	LINK
Vince Hagan	101803	Limit Switch	link

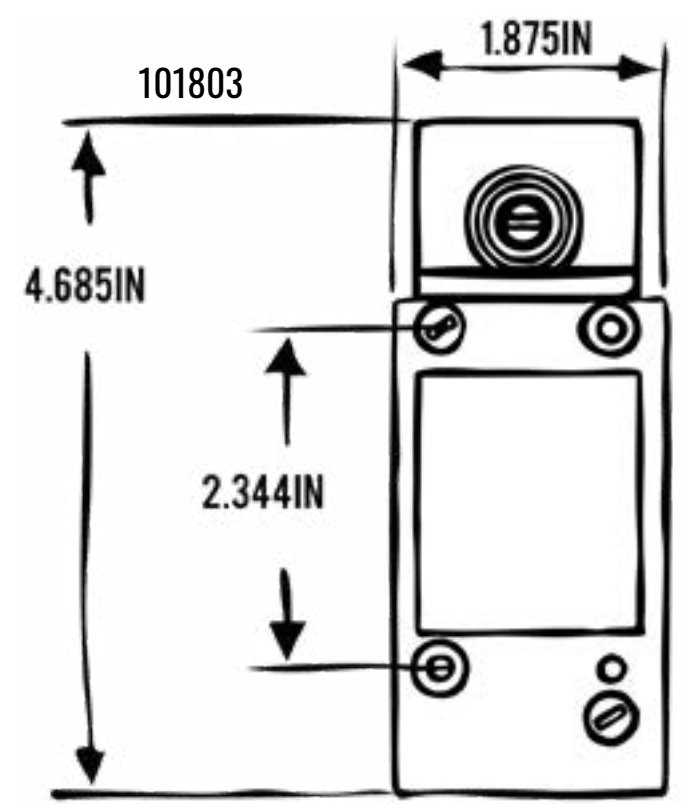

ELECTRICAL COMPONENTS



BRAND	PART #	DESCRIPTION	LINK
Vince Hagan	101805	Limit Switch Arm Lever	link



300221

BRAND	PART #	DESCRIPTION	LINK
Vince Hagan	300221	Baghouse Blower Motor Assembly	link

FILL LINE PARTS

BRAND	PART #	DESCRIPTION	LINK
Stephens	400AAL	Camlock Threaded Coupling	link

400AAL



400CAL

BRAND	PART #	DESCRIPTION	LINK
Stephens	400CAL	Cam & Groove - Aluminum	link

400DCAL



BRAND	PART #	DESCRIPTION	LINK
Stephens	400DCAL	Aluminum Camlock Dust Cap	link



400B

BRAND	PART #	DESCRIPTION	LINK
Stephens	400B	4in Buna Cam & Groove Gasket	link

BRAND	PART #	DESCRIPTION	LINK
Stephens	400DCALL	4in Aluminum Camlock Dust Cap Lockable	link



400DCALL

FILL LINE PARTS

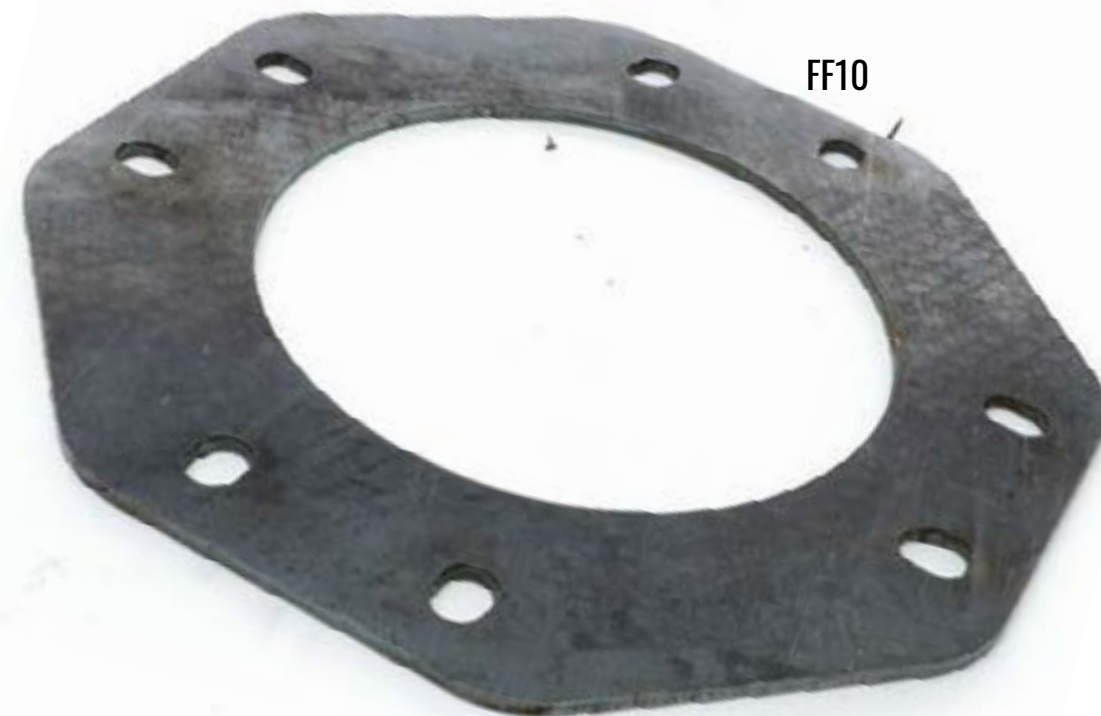

FF10

BRAND	PART #	DESCRIPTION	LINK
Stephens	FF10	10in Flat Straight Flange for 10in Bray Butterfly Valve	link

BRAND	PART #	DESCRIPTION	LINK
Stephens	ZPFLP5	5in Fill Line Gasket and Bolt Kit	link

BRAND	PART #	DESCRIPTION	LINK
Stephens	SORF1504	4in Sweep Elbow Flange	link



SORF1504

BRAND	PART #	DESCRIPTION	LINK
Stephens	159990	Schedule 80 Elbow	link

BRAND	PART #	DESCRIPTION	LINK
Stephens	SILOPIPE4	Cement Silo 4in Fill Pipe	link



WPFLYB

BRAND	PART #	DESCRIPTION	LINK
Stephens	WPFLYB	Cement Silo Flyash Metal Sign for Cement Fill Pipes	link

FILL LINE PARTS

BRAND	PART #	DESCRIPTION	LINK
-------	--------	-------------	------

Stephens WPSLAGB Silo SLAG Metal Sign for Cement Fill Pipe [link](#)



WPCEM1B



BRAND	PART #	DESCRIPTION	LINK
-------	--------	-------------	------

Stephens WPCEM1B Silo Cement 1 Metal Sign for Cement Fill Pipes [link](#)

BRAND	PART #	DESCRIPTION	LINK
-------	--------	-------------	------

Belgrade 4SCH40FILL Cement Silo 4in Fill Pipe [link](#)

BRAND	PART #	DESCRIPTION	LINK
-------	--------	-------------	------

C&W Dustech CM001 3in Adapter - Aluminum [link](#)



BRAND	PART #	DESCRIPTION	LINK
-------	--------	-------------	------

C&W Dustech CM006 4in Cam & Groove - Aluminum [link](#)

BRAND	PART #	DESCRIPTION	LINK
-------	--------	-------------	------

C&W Dustech CM004 4in Aluminum Camlock Dust Cap [link](#)



BRAND	PART #	DESCRIPTION	LINK
-------	--------	-------------	------

C&W Dustech CM023 5in Aluminum Cam & Groove Dust Cap [link](#)



FILL LINE PARTS

BRAND	PART #	DESCRIPTION	LINK
-------	--------	-------------	------

C&W Dustech CM007 4in Cam & Groove - Aluminum [link](#)



BRAND	PART #	DESCRIPTION	LINK
-------	--------	-------------	------

C&W Dustech CM005 4in Camlock Threaded Coupling [link](#)

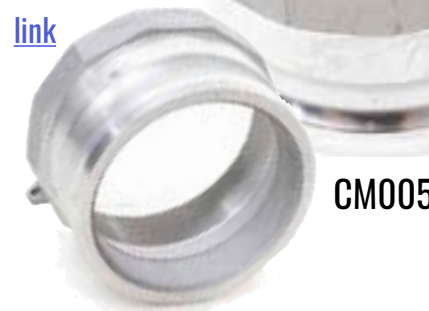

RB007



BRAND	PART #	DESCRIPTION	LINK
-------	--------	-------------	------

C&W Dustech RB007 .1875in Dust Collector Rubber Door Trim [link](#)

BRAND	PART #	DESCRIPTION	LINK
-------	--------	-------------	------

Con-E-Co 141846 3in Aluminum Camlock Dust Cap [link](#)

BRAND	PART #	DESCRIPTION	LINK
-------	--------	-------------	------

Con-E-Co 141860 4in Aluminum Camlock Dust Cap [link](#)



BRAND	PART #	DESCRIPTION	LINK
-------	--------	-------------	------

Con-E-Co 141880 5in Aluminum Cam & Groove Dust Cap [link](#)

141850



BRAND	PART #	DESCRIPTION	LINK
-------	--------	-------------	------

Con-E-Co 141850 5in Aluminum Cam & Groove Dust Cap [link](#)

FILL LINE PARTS

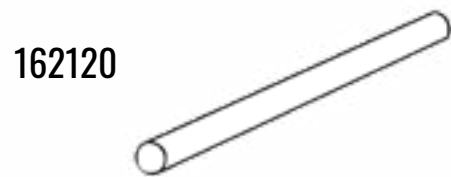

162120

BRAND	PART #	DESCRIPTION	LINK
Con-E-Co	162120	Cement Silo 4in Fill Pipe	link

BRAND	PART #	DESCRIPTION	LINK
Con-E-Co	141990	4in Threaded Pipe Companion Flange	link

BRAND	PART #	DESCRIPTION	LINK
Con-E-Co	141930	5in Threaded Pipe Companion Flange	link



141950

BRAND	PART #	DESCRIPTION	LINK
Con-E-Co	140870	4in Pipe Companion Flange Gasket	link

BRAND	PART #	DESCRIPTION	LINK
Con-E-Co	141950	5in Pipe Companion Flange Gasket	link

BRAND	PART #	DESCRIPTION	LINK
Con-E-Co	141921	4in Slip-On Weld Flange	link

BRAND	PART #	DESCRIPTION	LINK
Con-E-Co	140810	3in Slip-On Weld Flange	link

NO PICS



PL0026

BRAND	PART #	DESCRIPTION	LINK
Con-E-Co	PL0026	Flat Straight Flange for 10in Bray Butterfly Valve	link

FILL LINE PARTS

BRAND	PART #	DESCRIPTION	LINK
Con-E-Co	140790	2in Threaded Pipe Companion Flange	link

BRAND	PART #	DESCRIPTION	LINK
Con-E-Co	140850	2in Pipe Companion Flange Gasket	link

BRAND	PART #	DESCRIPTION	LINK
Con-E-Co	140800	3in Threaded Pipe Companion Flange	link

BRAND	PART #	DESCRIPTION	LINK
Con-E-Co	140860	3in Pipe Companion Flange Gasket	link



BRAND	PART #	DESCRIPTION	LINK
Con-E-Co	141920	5in Slip-On Weld Flange	link

BRAND	PART #	DESCRIPTION	LINK
Con-E-Co	141933	6in Slip-On Weld Flange	link



141920

BRAND	PART #	DESCRIPTION	LINK
Con-E-Co	140812	8in Slip-On Weld Flange	link

BRAND	PART #	DESCRIPTION	LINK
Con-E-Co	140813	10" Slip-On Weld Flange	link

FILL LINE PARTS

BRAND	PART #	DESCRIPTION	LINK
-------	--------	-------------	------

Con-E-Co 1237132 Pinch Valve for 4in Silo Fill Pipe [link](#)



BRAND	PART #	DESCRIPTION	LINK
-------	--------	-------------	------

Con-E-Co 0143623 Silo Cement 1 Metal Sign for Cement Fill Pipes [link](#)



0143624



BRAND	PART #	DESCRIPTION	LINK
-------	--------	-------------	------

Con-E-Co 0143624 Silo Flyash Metal Sign for Cement Fill Pipes [link](#)

BRAND	PART #	DESCRIPTION	LINK
-------	--------	-------------	------

Con-E-Co 1257406 U-Bolt Clamp for Silo Fill Pipe Signs [link](#)



FILL LINE PARTS

BRAND	PART #	DESCRIPTION	LINK
-------	--------	-------------	------

Con-E-Co 1109115 Silo SLAG Metal Sign for Cement Fill Pipe [link](#)



BRAND	PART #	DESCRIPTION	LINK
-------	--------	-------------	------

Liddell 900026001 4-Inch Pinch Valve Bladder [link](#)



BRAND	PART #	DESCRIPTION	LINK
-------	--------	-------------	------

Liddell R10000022 4in Pinch Valve [link](#)

BRAND	PART #	DESCRIPTION	LINK
-------	--------	-------------	------

Liddell R1000002201 4in Flange Pinch Valve End [link](#)

BRAND	PART #	DESCRIPTION	LINK
-------	--------	-------------	------

McNeilus 04074246 4in Aluminum Camlock Dust Cap [link](#)



BRAND	PART #	DESCRIPTION	LINK
-------	--------	-------------	------

McNeilus 04075248 5in Aluminum Cam & Groove Dust Cap [link](#)

BRAND	PART #	DESCRIPTION	LINK
-------	--------	-------------	------

McNeilus 1374991 3in Aluminum Camlock Dust Cap [link](#)



BRAND	PART #	DESCRIPTION	LINK
-------	--------	-------------	------

McNeilus 04075245 4in Camlock Threaded Coupling [link](#)

FILL LINE PARTS

10072503



BRAND	PART #	DESCRIPTION	LINK
-------	--------	-------------	------

McNeilus	10072503	2in Pipe Companion Flange Gasket	link
----------	----------	----------------------------------	----------------------

BRAND	PART #	DESCRIPTION	LINK
-------	--------	-------------	------

McNeilus	10072504	3in Pipe Companion Flange Gasket	link
----------	----------	----------------------------------	----------------------

10072504



BRAND	PART #	DESCRIPTION	LINK
-------	--------	-------------	------

McNeilus	10072512	Pipe 4in Companion Flange Gasket	link
----------	----------	----------------------------------	----------------------

BRAND	PART #	DESCRIPTION	LINK
-------	--------	-------------	------

McNeilus	1236873	5in Companion Flange Gasket	link
----------	---------	-----------------------------	----------------------

BRAND	PART #	DESCRIPTION	LINK
-------	--------	-------------	------

McNeilus	740101190	2in Threaded Pipe Companion Flange	link
----------	-----------	------------------------------------	----------------------

BRAND	PART #	DESCRIPTION	LINK
-------	--------	-------------	------

McNeilus	740101311	3in Threaded Pipe Companion Flange	link
----------	-----------	------------------------------------	----------------------

BRAND	PART #	DESCRIPTION	LINK
-------	--------	-------------	------

McNeilus	740101312	4in Threaded Pipe Companion Flange	link
----------	-----------	------------------------------------	----------------------

BRAND	PART #	DESCRIPTION	LINK
-------	--------	-------------	------

McNeilus	740101313	6in Threaded Pipe Companion Flange	link
----------	-----------	------------------------------------	----------------------

BRAND	PART #	DESCRIPTION	LINK
-------	--------	-------------	------

McNeilus	1108922	5in Threaded Pipe Companion Flange	link
----------	---------	------------------------------------	----------------------

no pics

FILL LINE PARTS

BRAND	PART #	DESCRIPTION	LINK
-------	--------	-------------	------

McNeilus	1108910	2in Slip-On Weld Flange	link
----------	---------	-------------------------	----------------------

BRAND	PART #	DESCRIPTION	LINK
-------	--------	-------------	------

McNeilus	1108911	3in Slip-On Weld Flange	link
----------	---------	-------------------------	----------------------

BRAND	PART #	DESCRIPTION	LINK
-------	--------	-------------	------

McNeilus	1108912	4in Slip-On Weld Flange	link
----------	---------	-------------------------	----------------------

BRAND	PART #	DESCRIPTION	LINK
-------	--------	-------------	------

McNeilus	1108914	6in Slip-On Weld Flange	link
----------	---------	-------------------------	----------------------

BRAND	PART #	DESCRIPTION	LINK
-------	--------	-------------	------

McNeilus	740101653	10in Flat Straight Flange for 10in Bray Butterfly Valve	link
----------	-----------	---	----------------------

BRAND	PART #	DESCRIPTION	LINK
-------	--------	-------------	------

McNeilus	1108913	5in Slip-On Weld Flange	link
----------	---------	-------------------------	----------------------

BRAND	PART #	DESCRIPTION	LINK
-------	--------	-------------	------

McNeilus	1228231	8in Slip-On Weld Flange	link
----------	---------	-------------------------	----------------------

1108913



740101653



740101653B

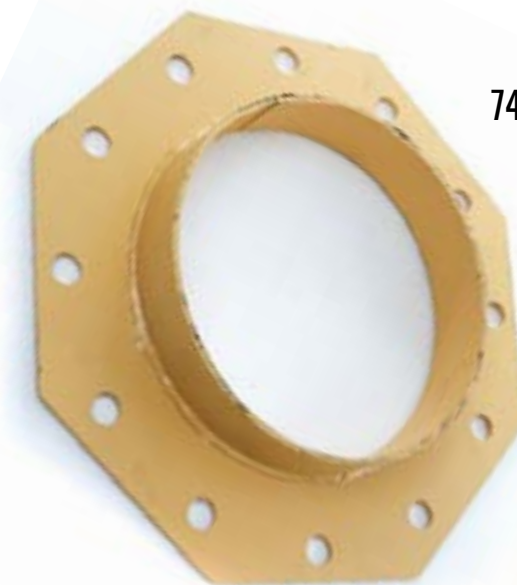

BRAND	PART #	DESCRIPTION	LINK
-------	--------	-------------	------

McNeilus	740101653B	Cement Silo Boot Flange	link
----------	------------	-------------------------	----------------------

FILL LINE PARTS



74072523

74072524

BRAND	PART #	DESCRIPTION	LINK
-------	--------	-------------	------

McNeilus	74072523	Pinch Valve for 4in Silo Fill Pipe	link
----------	----------	------------------------------------	----------------------

BRAND	PART #	DESCRIPTION	LINK
-------	--------	-------------	------

McNeilus	74072524	Pinch Valve for 5in Silo Fill Pipe	link
----------	----------	------------------------------------	----------------------

BRAND	PART #	DESCRIPTION	LINK
-------	--------	-------------	------

McNeilus	740143623	Silo Cement 1 Metal Sign for Cement Fill Pipes	link
----------	-----------	--	----------------------

740143623



740143624



BRAND	PART #	DESCRIPTION	LINK
-------	--------	-------------	------

McNeilus	740143624	Silo Flyash Metal Sign for Cement Fill Pipes	link
----------	-----------	--	----------------------

BRAND	PART #	DESCRIPTION	LINK
-------	--------	-------------	------

Vince Hagan	013995	Pinch Valve for 4in Silo Fill Pipe	link
-------------	--------	------------------------------------	----------------------



013995



014249

BRAND	PART #	DESCRIPTION	LINK
-------	--------	-------------	------

Vince Hagan	014249	Pinch Valve for 5in Silo Fill Pipe	link
-------------	--------	------------------------------------	----------------------

FILL LINE PARTS

BRAND	PART #	DESCRIPTION	LINK
-------	--------	-------------	------

WAM	KEBM40101	4in Extrabend Elbow for Filling Cement Silos	link
-----	-----------	--	----------------------



KEBM40101

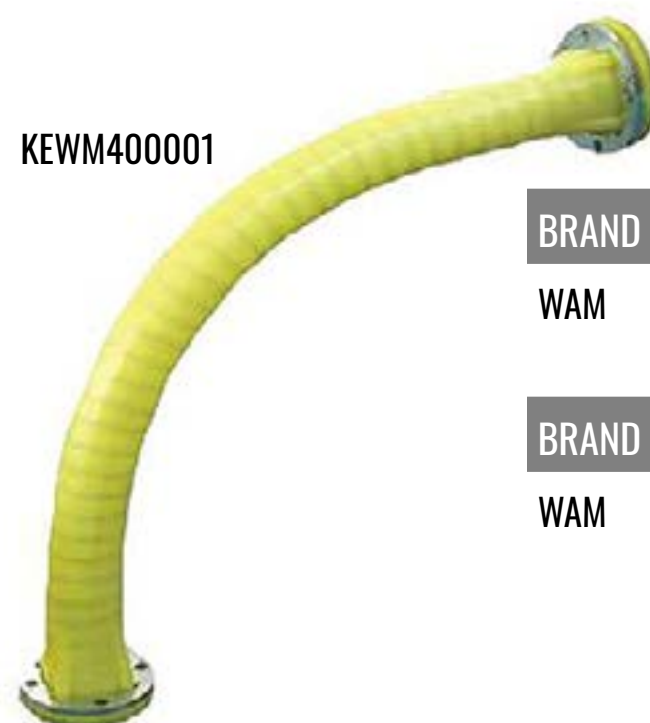

KEWM400001

BRAND	PART #	DESCRIPTION	LINK
-------	--------	-------------	------

WAM	KEWM400001	Extracurve Cement Silo 4in Radius Anti-Wear Elbow	link
-----	------------	---	----------------------

BRAND	PART #	DESCRIPTION	LINK
-------	--------	-------------	------

WAM	KEWM500	5in Plant Cement Silo Sweep Elbow	link
-----	---------	-----------------------------------	----------------------

BRAND	PART #	DESCRIPTION	LINK
-------	--------	-------------	------

WAM	VM100UN	Pinch Valve for 4in Silo Fill Pipe	link
-----	---------	------------------------------------	----------------------



VM125UN

BRAND	PART #	DESCRIPTION	LINK
-------	--------	-------------	------

WAM	VM125UN	Pinch Valve for 5in Silo Fill Pipe	link
-----	---------	------------------------------------	----------------------

BRAND	PART #	DESCRIPTION	LINK
-------	--------	-------------	------

WAM	VM20680091A	Elastomer Bladder for 3in Pinch Valve	link
-----	-------------	---------------------------------------	----------------------



VM100UN

BRAND	PART #	DESCRIPTION	LINK
-------	--------	-------------	------

WAM	VM20680111A	Elastomer Bladder for 4in Pinch Valve	link
-----	-------------	---------------------------------------	----------------------

BRAND	PART #	DESCRIPTION	LINK
WAM	KCSVMX01	Silo Anti-Overfill Safety System Pinch Valve Control Panel	link



BRAND	PART #	DESCRIPTION	LINK
WAM	XKF101	Counter Flange for 4in Pinch Valve VM	link

**PAGE
INTENTIONALLY
LEFT BLANK**

GATES

MP54161600



BRAND	PART #	DESCRIPTION	LINK
Stephens	MP54161600	Low Profile Aggregate Bin Gate	link



MP54141400

BRAND	PART #	DESCRIPTION	LINK
Stephens	MP54141400	14x14 Clam Gate for Aggregate Bins & Hoppers	link



MP54151500

BRAND	PART #	DESCRIPTION	LINK
Stephens	MP54151500	15x15 Clam Gate for Aggregate Bins & Hoppers	link

MP54202000



BRAND	PART #	DESCRIPTION	LINK
Stephens	MP54202000	20x20 Clam Gate for Aggregate Bins & Hoppers	link

MP54162000

NO PIC

BRAND	PART #	DESCRIPTION	LINK
Stephens	MP54162000	16x20 Clam Gate for Aggregate Bins & Hoppers	link

GATES

BRAND	PART #	DESCRIPTION	LINK
Stephens	MP54121200	12x12 Clam Gate - Gear Style	link



MP54121200

WP580050



BRAND	PART #	DESCRIPTION	LINK
Stephens	WP580050	Clamshell Gate Lug Eye Set for Aggregate Bin and Hopper Gates	link

24PSX30

BRAND	PART #	DESCRIPTION	LINK
Stephens	24PSX30	24 X 30 Clam Shell Gate - Gear Style	link



ES10



BRAND	PART #	DESCRIPTION	LINK
Stephens	ES10	10in Emergency Slide Gate	link
Stephens	ES12	12in Emergency Slide Gate	link

BRAND	PART #	DESCRIPTION	LINK
Belgrade	12AGGATE38	12in X 38in Replacement Aggregate Scale Discharge Gate	link

12AGGATE38

NO PIC

GATES

16AGGATE48

NO PIC

BRAND	PART #	DESCRIPTION	LINK
-------	--------	-------------	------

Belgrade 16AGGATE48 16in x 48in Aggregate Gate [link](#)

14x14AGGATE



BRAND	PART #	DESCRIPTION	LINK
-------	--------	-------------	------

Belgrade 14x14AGGATE 14x14 Clam Gate for Aggregate Bins & Hoppers [link](#)

14x14AGGATE



BRAND	PART #	DESCRIPTION	LINK
-------	--------	-------------	------

Belgrade 16AGGATE16 16x16 Low Profile Aggregate Bin Clam Gate [link](#)

0072915



BRAND	PART #	DESCRIPTION	LINK
-------	--------	-------------	------

Con-E-Co 0072915 12x12 Clam Gate - Gear Style [link](#)

0072990



BRAND	PART #	DESCRIPTION	LINK
-------	--------	-------------	------

Con-E-Co 0072990 14x14 Clam Gate for Aggregate Bins & Hoppers [link](#)

0072980



BRAND	PART #	DESCRIPTION	LINK
-------	--------	-------------	------

Con-E-Co 0072980 15x15 Clam Gate for Aggregate Bins & Hoppers [link](#)

GATES

BRAND	PART #	DESCRIPTION	LINK
-------	--------	-------------	------

Con-E-Co 0072995 16x16 Low Profile Aggregate Bin Gate [link](#)

0072995



0072950

BRAND	PART #	DESCRIPTION	LINK
-------	--------	-------------	------

Con-E-Co 0072950 18x18 Clam Gate for Aggregate Bins & Hoppers [link](#)

BRAND	PART #	DESCRIPTION	LINK
-------	--------	-------------	------

Con-E-Co 0072940 24x24 Clam Gate - Gear Style [link](#)



0072940



0115088

BRAND	PART #	DESCRIPTION	LINK
-------	--------	-------------	------

Con-E-Co 0115088 Plant Aggregate Gate Nylatron Bushing [link](#)

BRAND	PART #	DESCRIPTION	LINK
-------	--------	-------------	------

Con-E-Co 0143275 Plant Batcher Gate Assembly [link](#)

NO PIC

NO PIC

BRAND	PART #	DESCRIPTION	LINK
-------	--------	-------------	------

Con-E-Co 0143069 Plant Aggregate Bin Gate Arm Mounting Pin [link](#)

BRAND	PART #	DESCRIPTION	LINK
-------	--------	-------------	------

Con-E-Co 0143064 Plant Aggregate Bin Gate Mounting Plate [link](#)

Con-E-Co 0143064P Plant Aggregate Bin Gate Mounting Plate - Including Pin [link](#)



0143064

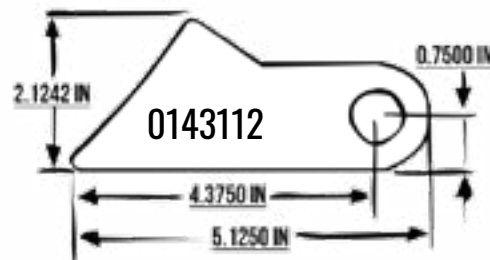

BRAND	PART #	DESCRIPTION	LINK
-------	--------	-------------	------

Con-E-Co 0143112 Gate Lug [link](#)



0143114

BRAND	PART #	DESCRIPTION	LINK
-------	--------	-------------	------

Con-E-Co 0143114 Bin Clam Gate Cylinder Mount [link](#)

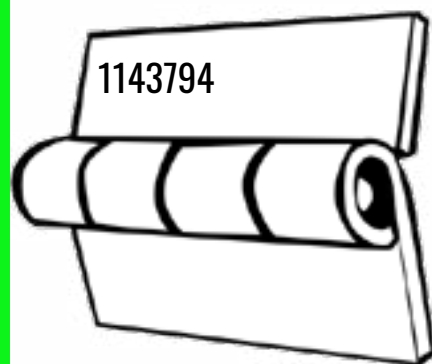

1143794

BRAND	PART #	DESCRIPTION	LINK
-------	--------	-------------	------

Con-E-Co 1143794 Agg Bin Side Panel Hinge Assembly [link](#)

BRAND	PART #	DESCRIPTION	LINK
-------	--------	-------------	------

Con-E-Co 1523771 Gate Agg Bin 4 Inline [link](#)

NO PIC

NO PIC

BRAND	PART #	DESCRIPTION	LINK
-------	--------	-------------	------

Con-E-Co BM100361 Single Gate Inline [link](#)

BRAND	PART #	DESCRIPTION	LINK
-------	--------	-------------	------

Con-E-Co 0143154 Agg Bin Gate Linkage Bar - Short [link](#)

NO PIC

NO PIC

BRAND	PART #	DESCRIPTION	LINK
-------	--------	-------------	------

Con-E-Co 0143122 BatchMaster Agg, Feed gate - Link Bar Long [link](#)

BRAND	PART #	DESCRIPTION	LINK
-------	--------	-------------	------

Liddell R10000001 Gate Gear Segment Complete with Grease Bolt & End Plate [link](#)



BRAND	PART #	DESCRIPTION	LINK
-------	--------	-------------	------

Liddell R10000392 24x24 Clam Gate-Gear Style [link](#)



R10000392

BRAND	PART #	DESCRIPTION	LINK
-------	--------	-------------	------

Liddell R10000272 GATE BOLT (ROSS) #0001 [link](#)

R10000272

BRAND	PART #	DESCRIPTION	LINK
-------	--------	-------------	------

McNeilus 74072915 12in x 12in Gear Style Clam Shell Gate [link](#)



74072915

BRAND	PART #	DESCRIPTION	LINK
-------	--------	-------------	------

McNeilus 74072990 14x14 Clam Gate for Aggregate Bins and Hoppers [link](#)

74072990

BRAND	PART #	DESCRIPTION	LINK
-------	--------	-------------	------

McNeilus 74072980 15x15 Clam Gate for Aggregate Bins and Hoppers [link](#)



74072980

GATES



BRAND	PART #	DESCRIPTION	LINK
McNeilus	74072995	16x16 Low Profile Aggregate Bin Gate	link



BRAND	PART #	DESCRIPTION	LINK
McNeilus	74072950	Concrete Plant 18x18 Double Clam Aggregate Gate	link



BRAND	PART #	DESCRIPTION	LINK
McNeilus	74072905	20x20 Clam Gate for Aggregate Bins and Hoppers	link

74072940



BRAND	PART #	DESCRIPTION	LINK
McNeilus	74072940	24 x 24 Clam Gate-Gear Style	link



BRAND	PART #	DESCRIPTION	LINK
McNeilus	740115088	Aggregate Gate Deltron Bushing	link

GATES

BRAND	PART #	DESCRIPTION	LINK
McNeilus	740101653	10in Flat Straight Flange for 10in Bray Butterfly Valve	link



BRAND	PART #	DESCRIPTION	LINK
McNeilus	740101653B	Cement Silo Boot Flange	link

BRAND	PART #	DESCRIPTION	LINK
McNeilus	740143275	Aggregate Batcher Gate Assembly	link

NO PIC

VLQ150M1

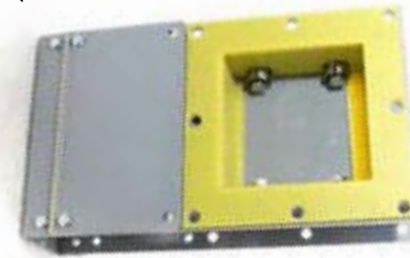

BRAND	PART #	DESCRIPTION	LINK
WAM	VLQ150M1	6in Slide Gate	link

VLQ200M1

BRAND	PART #	DESCRIPTION	LINK
WAM	VLQ200M1	Slide Gate Valve D. 8 IN STEELGATE and BODY EU	link



VLQ250M1



BRAND	PART #	DESCRIPTION	LINK
WAM	VLQ250M1	10in Slide Gate Valve	link

GATES

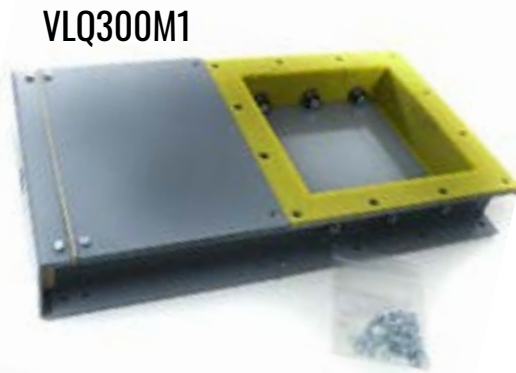

BRAND	PART #	DESCRIPTION	LINK
WAM	VLQ300M1	12in Slide Gate Valve	link

BRAND	PART #	DESCRIPTION	LINK
WAM	VLQ350M1	14in Steel Slide Gate	link

VLQ400M1



BRAND	PART #	DESCRIPTION	LINK
WAM	VLQ400M1	14in Steel Slide Gate	link

BRAND	PART #	DESCRIPTION	LINK
WAM	CMG150I	Slide Gate Manual Hand Wheel	link



CMG0200I



BRAND	PART #	DESCRIPTION	LINK
WAM	CMG0200I	Slide Gate Manual Hand Wheel	link

BRAND	PART #	DESCRIPTION	LINK
WAM	CMG0250I	Slide Gate Manual Hand Wheel	link



GATES

BRAND	PART #	DESCRIPTION	LINK
WAM	CMG0300I	Slide Gate Manual Hand Wheel	link



NO PIC

BRAND	PART #	DESCRIPTION	LINK
WAM	CMG0400I	Slide Gate Manual Hand Wheel	link

BOOTS



A127B29



BRAND	PART #	DESCRIPTION	LINK
MPParts	A12B3C3	10in Diameter Vinyl Boot	link
MPParts	A127B29	10.5in Diameter Vinyl Boot	link
MPParts	A12AD7E	12.5in Diameter Vinyl Boot	link
MPParts	A12A7DF	14in Diameter Vinyl Boot	link
MPParts	A12AC1A	21in Diameter Vinyl Boot	link

BRAND	PART #	DESCRIPTION	LINK
Stephens	PGT10	10in Gum Rubber Boot	link
Stephens	PGT12	12in Gum Rubber Boot	link
Stephens	PGT24	24in Gum Rubber Boot	link
Stephens	PGT675	Gum Rubber Boot	link

BRAND	PART #	DESCRIPTION	LINK
Stephens	VF1200	12in PVC Blue Discharge	link

BOOTS

WPB19328007



BRAND	PART #	DESCRIPTION	LINK
Stephens	WPB19328007	7in Wide Boot Clamp	link

BRAND	PART #	DESCRIPTION	LINK
Stephens	WPB19328010	Cement Silo 10in Wide Boot Clamp	link

WPB19328011



BRAND	PART #	DESCRIPTION	LINK
Stephens	WPB19328011	Heavy Duty Metal Boot Clamp for 24in Diameter Plant Boots and Shrouds	link

BRAND	PART #	DESCRIPTION	LINK
Stephens	WPB19328013	20in Diameter Cement Silo Boot Clamp	link

WPB19328014



BRAND	PART #	DESCRIPTION	LINK
Stephens	WPB19328014	Heavy Duty Cement Silo 14in-18in Diameter Diameter Wide Boot Clamp	link

BRAND	PART #	DESCRIPTION	LINK
Stephens	WPB19328015	Heavy Duty Metal Boot Clamp for 25in Diameter Plant Boots and Shrouds	link



WPB19328010



WPB19328013



WPB19328015

BOOTS

BRAND	PART #	DESCRIPTION	LINK
Stephens	WPB19328032	30in Boot Clamp	link

no pic

BRAND	PART #	DESCRIPTION	LINK
Con-E-Co	0215291	10in x 8in Tapered Gum Rubber Boot	link

no pic

BRAND	PART #	DESCRIPTION	LINK
Con-E-Co	143780	10.625in Plant Rubber Boot	link

143780



144043



BRAND	PART #	DESCRIPTION	LINK
Con-E-Co	144043	8.5in ID x 12in Long Hypalon Cement Boot Shroud	link

144021



BRAND	PART #	DESCRIPTION	LINK
Con-E-Co	144021	10.5-In ID x 14-In Long Hypalon Cement Boot Shroud	link

no pic

BRAND	PART #	DESCRIPTION	LINK
Con-E-Co	144022	10.5in ID x 16in Long Hypalon Cement Boot Shroud	link

BRAND	PART #	DESCRIPTION	LINK
Con-E-Co	144013	12.5in ID x 18in Long Hypalon Cement Boot Shroud	link

144013



BOOTS

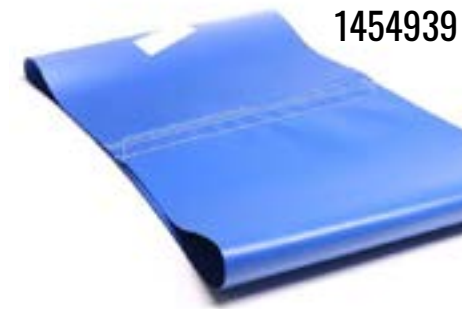

1454939

BRAND	PART #	DESCRIPTION	LINK
Con-E-Co	1454939	Tapered Vinyl Shroud Boot 12.5-Inches x 10.5-Inches x 12-Inches Long	link

Con-E-Co	0116919	Tapered Canvas Boot 8in x 5/8in thick X 10in - 7/8in thick at 9in Long	link
----------	---------	--	----------------------



141650

BRAND	PART #	DESCRIPTION	LINK
Con-E-Co	141650*	8in Quick Release Boot Clamp - 2in-21.5in Diameter Stainless Steel	link
Con-E-Co	1236864*	10in Quick Release Boot Clamp - 2in-21.5in Diameter Stainless Steel	link
Con-E-Co	1236865*	10in-12in Quick Release Boot Clamp - 2in-21.5in Diameter Stainless Steel	link
Con-E-Co	1236866*	10in-16in Full Thread Quick Release Boot Clamp - 2in-21.5in Diameter Stainless Steel	link
Con-E-Co	141694*	15in - 17in Quick Release Boot Clamp - 2in-21.5in Diameter Stainless Steel	link
Con-E-Co	1236867*	20in Quick Release Boot Clamp - 2in-21.5in Diameter Stainless Steel	link

*MPParts A124139 Universal Clamp covers all these Con-E-Co part numbers

BOOTS

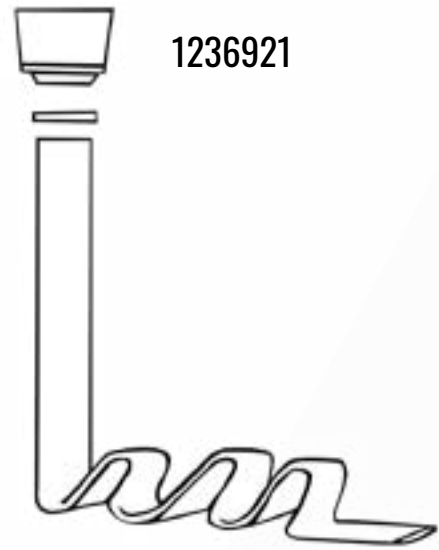

1236921

BRAND	PART #	DESCRIPTION	LINK
-------	--------	-------------	------

Con-E-Co	1236921	8in x 50ft PVC Elephant Trunk	link
----------	---------	-------------------------------	----------------------

* Other diameters available
** Sold by the Running Foot



900026005

BRAND	PART #	DESCRIPTION	LINK
-------	--------	-------------	------

Liddell	900026005	10.625in Plant Rubber Boot	link
Liddell	R10000001311	EPDM Black Vinyl Boot 25in ID x 30In Long	link
Liddell	R10000001101	8in x 10.5in 14in Long Black Tapered Boot	link
Liddell	R10000001413	13.5in to 10.75in Inner Diameter x 26.5in Long Tapered Gum Rubber Boot	link
Liddell	R10000001414	13in to 11in Inner Diameter x 21in Long x .25in Thick Tapered Gum Rubber Boot	link
Liddell	R10000001428	10- .75in Inner Diameter Vinyl Boot	link
Liddell	R10000001427	12- .75in Inner Diameter Vinyl Boot	link
Liddell	R02000528	28in Boot Clamp HD	link

BOOTS

120115222



BRAND	PART #	DESCRIPTION	LINK
-------	--------	-------------	------

McNeilus	120115222	10.625in Plant Rubber Boot	link
----------	-----------	----------------------------	----------------------

1236991



BRAND	PART #	DESCRIPTION	LINK
-------	--------	-------------	------

McNeilus	1236991	8.5in ID x 12in Long Hypalon Cement Boot Shroud	link
----------	---------	---	----------------------



1236986

BRAND	PART #	DESCRIPTION	LINK
-------	--------	-------------	------

McNeilus	1236986	10.5in ID x 14in Long Hypalon Cement Boot Shroud	link
----------	---------	--	----------------------

BRAND	PART #	DESCRIPTION	LINK
-------	--------	-------------	------

McNeilus	1236983	12.5in ID x 18in Long Hypalon Cement Boot Shroud for Ready Mix Concrete Batch Plants	link
----------	---------	--	----------------------



1236983

BATCH PLANT LINERS

BRAND	PART #	DESCRIPTION	LINK
-------	--------	-------------	------

Stephens MLST00TH04KG83 Turnhead Liner Set [link](#)

no pic

BRAND	PART #	DESCRIPTION	LINK
-------	--------	-------------	------

Con-E-Co 143948 Turnhead Urethane Liner Kit [link](#)

no pic

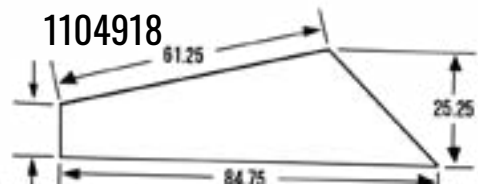

BRAND	PART #	DESCRIPTION	LINK
-------	--------	-------------	------

Con-E-Co 1104918 Plant Turnhead Side Liner [link](#)

BRAND	PART #	DESCRIPTION	LINK
-------	--------	-------------	------

Con-E-Co 1104917 Plant Turnhead Side Liner [link](#)

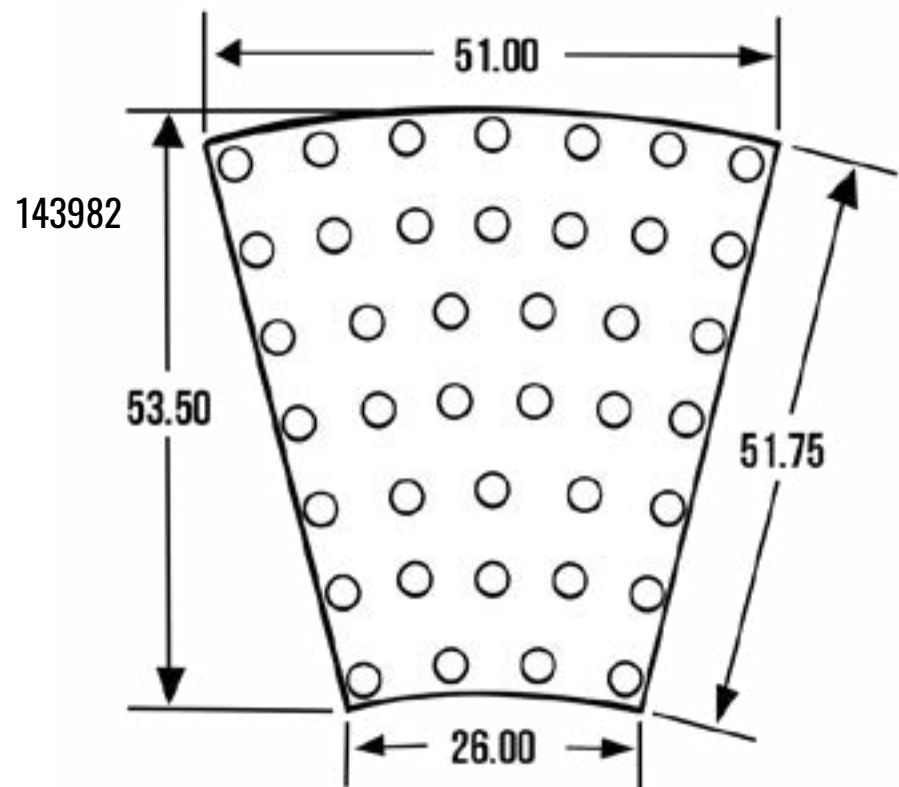
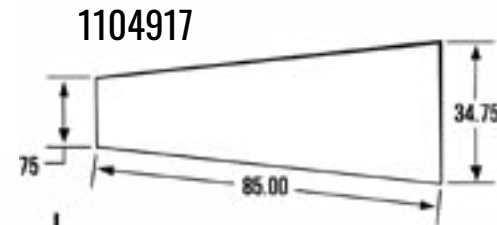

BRAND	PART #	DESCRIPTION	LINK
-------	--------	-------------	------

Con-E-Co 143982 Model 12S Liner Mixer Discharge Cone "B" [link](#)

BATCH PLANT LINERS

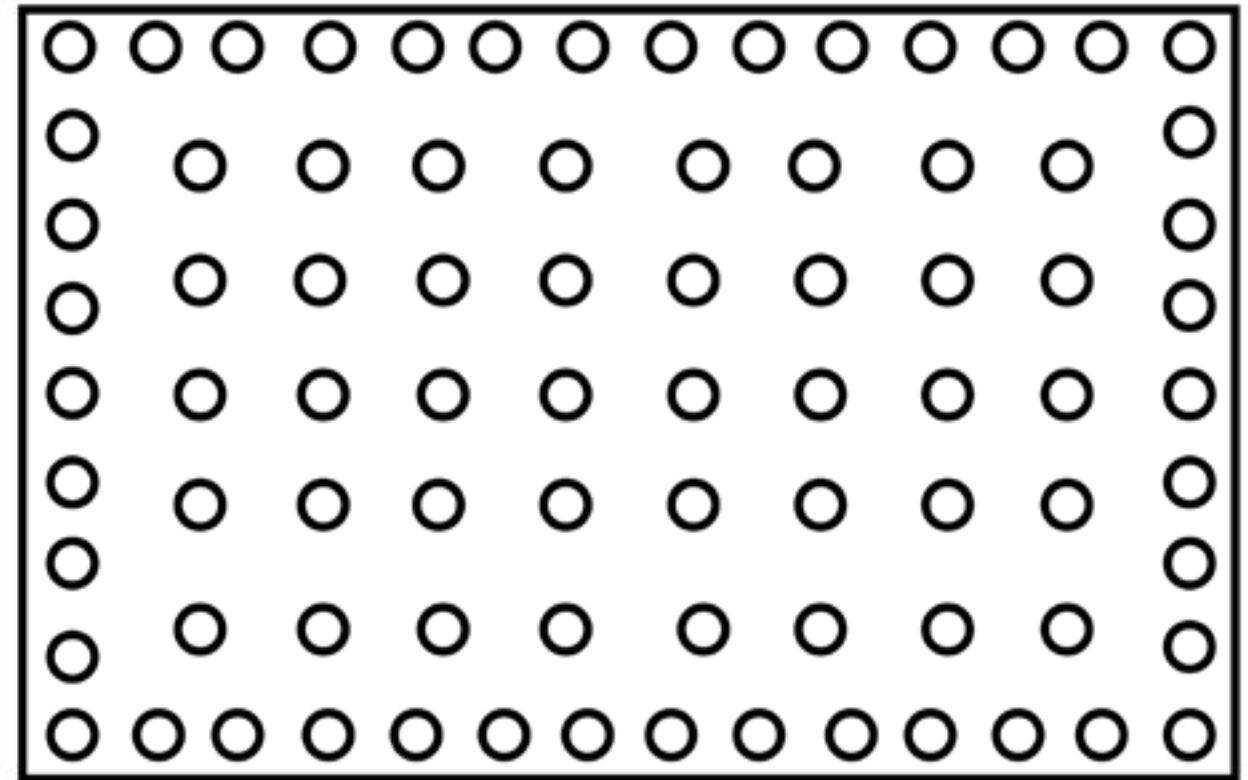

BRAND	PART #	DESCRIPTION	LINK
-------	--------	-------------	------

Con-E-Co 1236951 Tilt Mixer Paddle Center Strip #2 Liner [link](#)

Con-E-Co 1236950 Tilt Mixer Paddle Short Center Strip #1 Liner [link](#)

Con-E-Co 1236949 Tilt Mixer Paddle Long Center Strip #2 Liner [link](#)

Con-E-Co BP000036K 12yd Nose Cone Liners [link](#)

Con-E-Co BP000035K 12yd Discharge Cone Liners [link](#)

Con-E-Co BP000034K 12yd Charge Cone Liners [link](#)

Con-E-Co BP000033K 12yd Tilt Belly Section Liner [link](#)

Erie Strayer Drum Liner Diagram

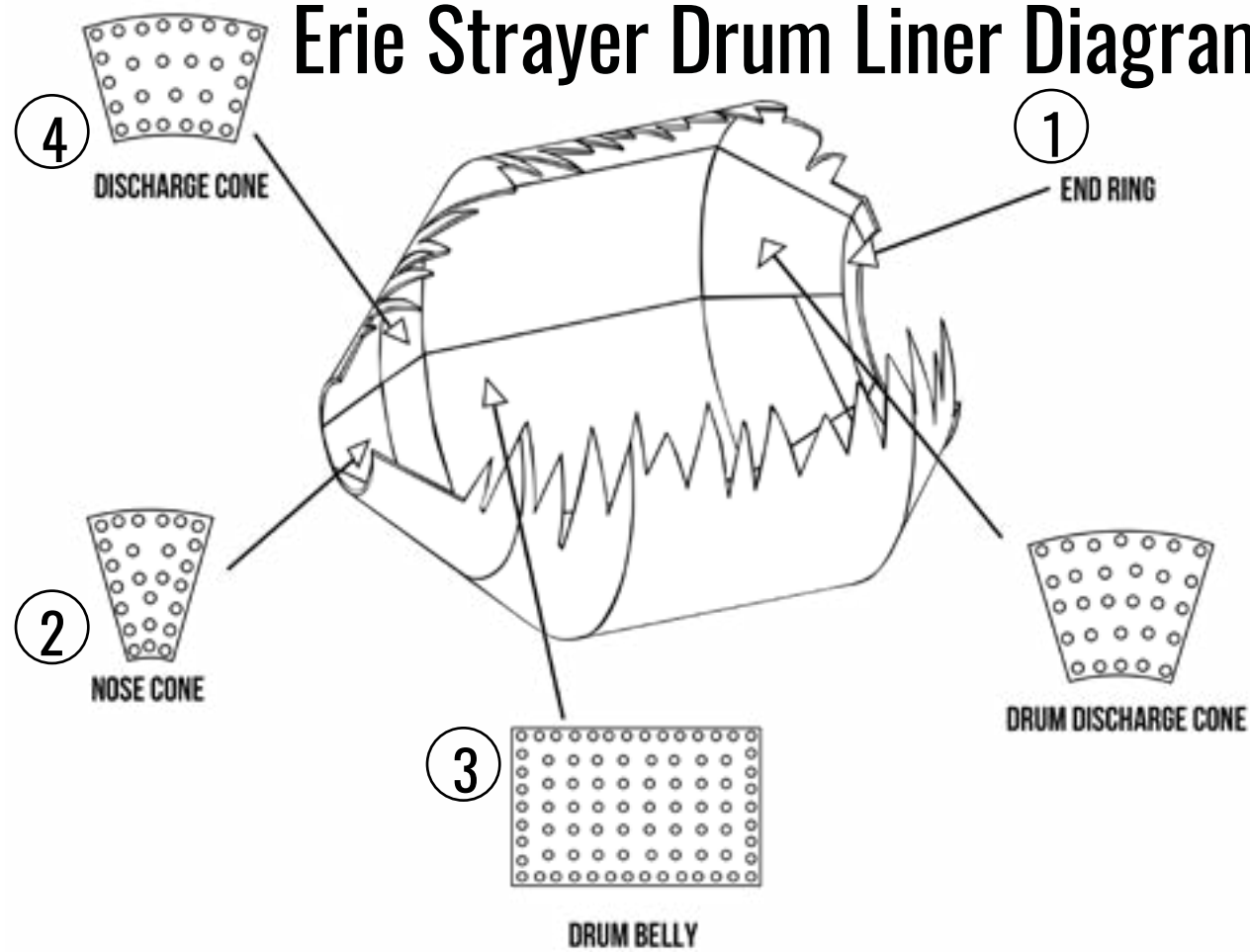

BRAND	PART #	DESCRIPTION	LINK
Erie Strayer	53360	(1) Tilt Mixer End Ring Liner	link
Erie Strayer	53358	Charge Cone Liner	link
Erie Strayer	BP000061	(2) Nose Cone Liners	link
Erie Strayer	BP000058	(3) 12YD Belly Liner - 1in Thick	link
Erie Strayer	BP000059	(4) Discharge Cone Liner - 1in Thick	link
Erie Strayer	BP000085	Nose Cone 26.6in OPG Urethane Liner	link
Erie Strayer	BP020848	1in Urethane Turnhead Bottom Liner 89in Long	link
Erie Strayer	BP020847	1in Urethane Turnhead Left Hand Side Liner 85.188in Long	link
Erie Strayer	BP020849	1in Urethane Turnhead Right Hand Side Liner 85.188in Long	link
Erie Strayer	59792	12 Yard Drum Liner	link
Erie Strayer	62333	15 Degree Inlet Ring	link

McNeilus Turnhead Liner Diagram

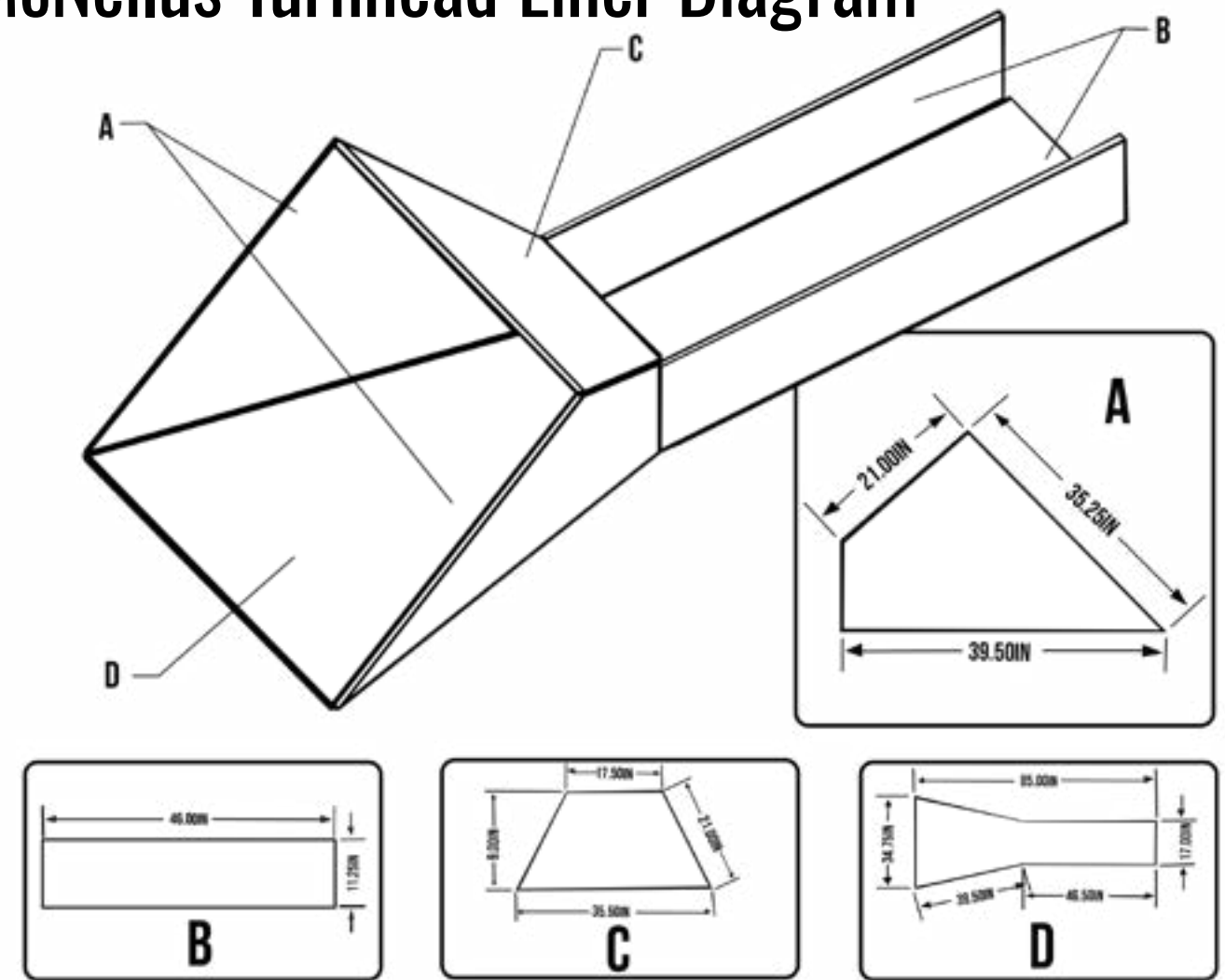

BRAND	PART #	DESCRIPTION	LINK
McNeilus	740145654	Aggregate Bin Turnhead Liner	link

McNeilus Turnhead Assembly

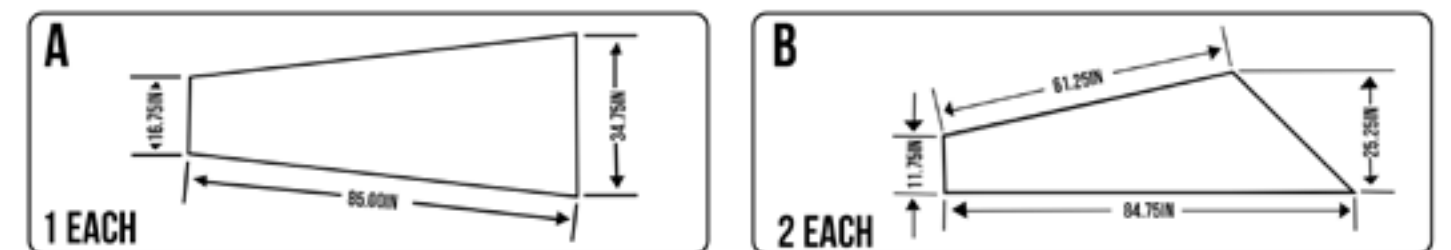

BRAND	PART #	DESCRIPTION	LINK
McNeilus	1236952	3 Piece Turnhead Urethane Liner Kit	link

Rexcon Standard 3 Piece Dump Cone

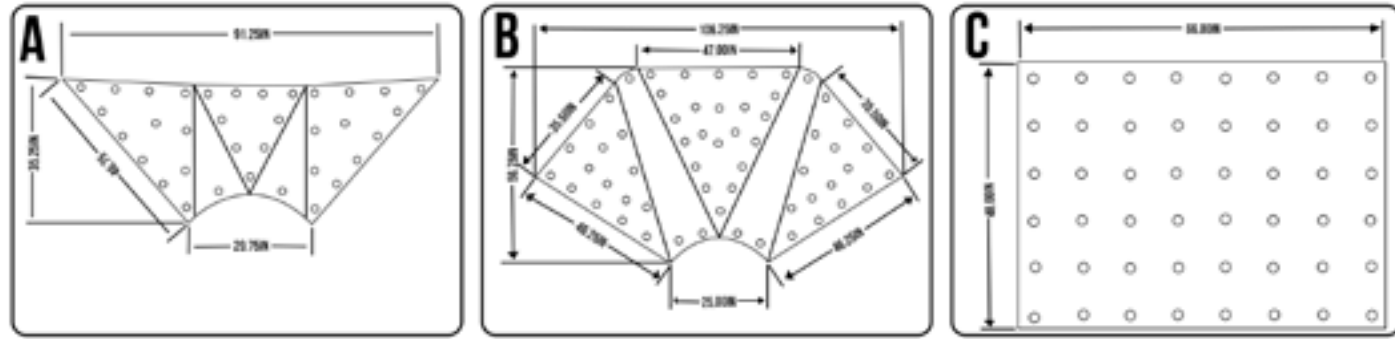

BRAND	PART #	DESCRIPTION	LINK
Rexcon	5120602788	3 Piece Dump Cone with Poly Liners	link

551056644921

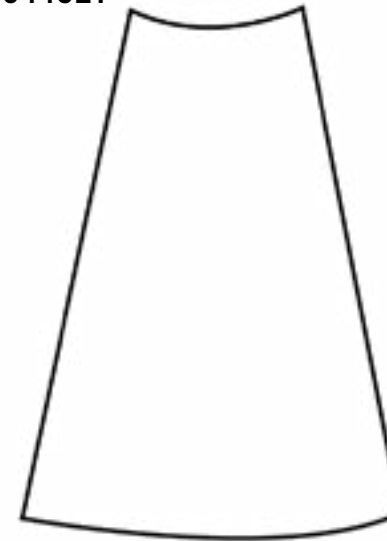

BRAND	PART #	DESCRIPTION	LINK
Terex Johnson Ross	551056644921	Front Cone Liner #1	link

551056644922

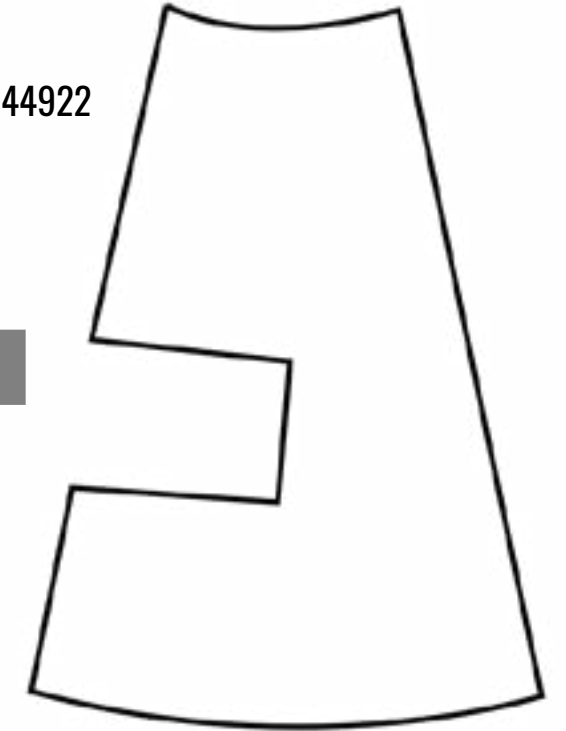

BRAND	PART #	DESCRIPTION	LINK
Terex Johnson Ross	551056644922	Front Cone Liner #2	link

551056644925

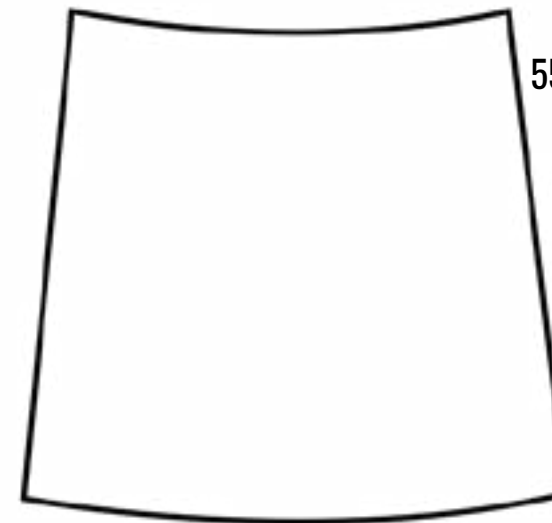

BRAND	PART #	DESCRIPTION	LINK
Terex Johnson Ross	551056644925	Rear Cone Liner #5	link

5510566449211

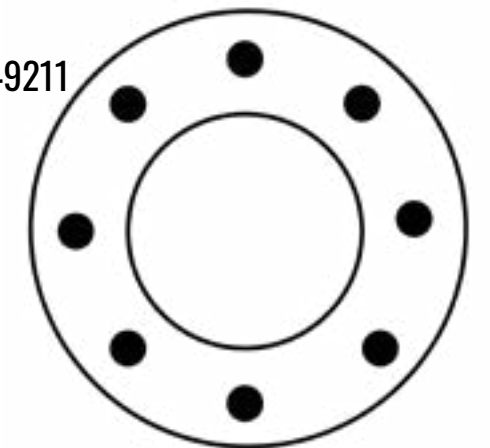

BRAND	PART #	DESCRIPTION	LINK
Terex Johnson Ross	5510566449211	Spindle Ring Liner #11	link

Precision PPI Part Numbering System

C5-35TE-36SB

CEMA Series
B, C, D, E, F

Roll Diameter
B - 4.5in
C - 4in, 5in, 6in
D - 5in, 6in
E - 6in, 7in
F - 6in, 7in, 8in

Angle (Degrees)
10, 15, 20, 35, 45

Bearing Type
SB = Sealed Ball Bearing

Belt Width
B - 14in to 48in
C - 18in to 60in
D - 24in to 72in
E - 36in to 96in
F - 60in to 120in

Frame Type - TE for Troughing Equal
For others, see Idler Type list

Note: Angle does not apply to flat or standard return idlers. Certain limitations apply, such as 10 for VR, 15 for IVR, and 20, 35, and 45 for TE

IDLER TYPE LIST

TE	Troughing Equal
TEI	Troughing Equal Impact
TESA	Troughing Equal Self Aligner
TU	Troughing Unequal
TUI	Troughing Unequal Impact
CIT	Channel Inset Troughing
CITI	Channel Inset Troughing Impact
F	Flat
FRD	Flat Rubber Disc
FSA	Flat Self-Aligner
CIF	Channel Inset Flat
CIFRD	Channel Inset Flat Rubber Disc
R	Return
RRD	Return Rubber Disc
RSA	Return Self Aligner
RRDSA	Return Rubber Disc Self-Aligner
CIR	Channel Inset Return

CIRRD	Channel Inset Return Rubber Disc
VR	V-Return
VRI	V-Return Impact
IVR	Inverted V-Return
IVRI	Inverted V-Return Impact
LSI	Live Shaft Impact
LSRRD	Live Shaft Return Rubber Disc
LSR	Live Shaft Return (Steel)
TIS	Troughing Impact System
TISZ	Troughing Impact System (2 foot)
EZI	EZ Slider with Impact Rolls
TET	Troughing Equal Transition
GRT	Guide Roll Troughing
GRF	Guide Roll Flat
GRR	Guide Roll Return
SAD X CSR	Smart Roll Clean Side Return

For other types, consult your MPParts sales rep!

Figures used are for dimensional reference only. Some variation may occur from any illustrations

BRAND	PART #	DESCRIPTION	LINK
PPI	B420TE24SB	20 Degree Equal Troughing Idler	link



BRAND	PART #	DESCRIPTION	LINK
PPI	B520TE24SB	20 Degree Equal Troughing Idler	link

BRAND	PART #	DESCRIPTION	LINK
PPI	B420TE30SB	20 Degree Equal Troughing Idler	link



NO PIC

BRAND	PART #	DESCRIPTION	LINK
PPI	B520TE30SB	20 Degree Equal Troughing Idler	link

BRAND	PART #	DESCRIPTION	LINK
PPI	B420TE36SB	20 Degree Equal Troughing Idler	link



NO PIC

BRAND	PART #	DESCRIPTION	LINK
PPI	B420TE42SB	20 Degree Equal Troughing Idler	link

BRAND	PART #	DESCRIPTION	LINK
PPI	B520TE42SB	20 Degree Equal Troughing Idler	link

NO PIC



B435TE18SB

BRAND	PART #	DESCRIPTION	LINK
PPI	B435TE18SB	35 Degree Equal Troughing Idler	link

PRECISION BATCH PLANT IDLERS

BRAND	PART #	DESCRIPTION	LINK
-------	--------	-------------	------

PPI B435TE24SB 35 Degree Equal Troughing Idler [link](#)



BRAND	PART #	DESCRIPTION	LINK
-------	--------	-------------	------

PPI B535TE24SB 35 Degree Equal Troughing Idler [link](#)

BRAND	PART #	DESCRIPTION	LINK
-------	--------	-------------	------

PPI B435TE30SB 35 Degree Equal Troughing Idler [link](#)



BRAND	PART #	DESCRIPTION	LINK
-------	--------	-------------	------

PPI B535TE30SB 35 Degree Equal Troughing Idler [link](#)

BRAND	PART #	DESCRIPTION	LINK
-------	--------	-------------	------

PPI B435TE36SB 35 Degree Equal Troughing Idler [link](#)



BRAND	PART #	DESCRIPTION	LINK
-------	--------	-------------	------

PPI B435TE48SB 35 Degree Equal Troughing Idler [link](#)

BRAND	PART #	DESCRIPTION	LINK
-------	--------	-------------	------

PPI B445TE30SB 45 Degree Equal Troughing Idler [link](#)



BRAND	PART #	DESCRIPTION	LINK
-------	--------	-------------	------

PPI B420TE18SB 20 Degree Equal Impact Troughing Idler [link](#)

PRECISION BATCH PLANT IDLERS

BRAND	PART #	DESCRIPTION	LINK
-------	--------	-------------	------

PPI B520TE18SB 20 Degree Equal Impact Troughing Idler [link](#)



BRAND	PART #	DESCRIPTION	LINK
-------	--------	-------------	------

PPI B420TE18SB 20 Degree Equal Impact Troughing Idler [link](#)

BRAND	PART #	DESCRIPTION	LINK
-------	--------	-------------	------

PPI B520TE124SB 20 Degree Equal Impact Troughing Idler [link](#)



BRAND	PART #	DESCRIPTION	LINK
-------	--------	-------------	------

PPI B420TE130SB 20 Degree Equal Impact Troughing Idler [link](#)

BRAND	PART #	DESCRIPTION	LINK
-------	--------	-------------	------

PPI B520TE130SB 20 Degree Equal Impact Troughing Idler [link](#)



BRAND	PART #	DESCRIPTION	LINK
-------	--------	-------------	------

PPI B420TE136SB 20 Degree Equal Impact Troughing Idler [link](#)

BRAND	PART #	DESCRIPTION	LINK
-------	--------	-------------	------

PPI B520TE136SB 20 Degree Equal Impact Troughing Idler [link](#)



BRAND	PART #	DESCRIPTION	LINK
-------	--------	-------------	------

PPI B520TE142SB 20 Degree Equal Impact Troughing Idler [link](#)

BRAND	PART #	DESCRIPTION	LINK
-------	--------	-------------	------

PPI B420TE148SB Troughing Idler [link](#)



PRECISION BATCH PLANT IDLERS

no pic

BRAND	PART #	DESCRIPTION	LINK
PPI	B520TEI54SB	20 Degree Equal Impact Troughing Idler	link

BRAND	PART #	DESCRIPTION	LINK
PPI	B435TEI18SB	35 Degree Equal Impact Troughing Idler	link



BRAND	PART #	DESCRIPTION	LINK
PPI	B535TEI18SB	35 Degree Equal Impact Troughing Idler	link

BRAND	PART #	DESCRIPTION	LINK
PPI	B435TEI24SB	35 Degree Equal Impact Troughing Idler	link



BRAND	PART #	DESCRIPTION	LINK
PPI	B535TEI18SB	35 Degree Equal Impact Troughing Idler	link



PRECISION BATCH PLANT IDLERS

BRAND	PART #	DESCRIPTION	LINK
PPI	B535TEI30SB	35 Degree Equal Impact Troughing Idler	link



BRAND	PART #	DESCRIPTION	LINK
PPI	B435TEI36SB	35 Degree Equal Impact Troughing Idler	link



BRAND	PART #	DESCRIPTION	LINK
PPI	B535TEI36SB	35 Degree Equal Impact Troughing Idler	link

BRAND	PART #	DESCRIPTION	LINK
PPI	B435TEI42SB	35 Degree Equal Impact Troughing Idler	link



BRAND	PART #	DESCRIPTION	LINK
PPI	B535TEI42SB	35 Degree Equal Impact Troughing Idler	link

BRAND	PART #	DESCRIPTION	LINK
PPI	B435TEI48SB	35 Degree Equal Impact Troughing Idler	link



BRAND	PART #	DESCRIPTION	LINK
PPI	B535TEI48SB	35 Degree Equal Impact Troughing Idler	link

PRECISION BATCH PLANT IDLERS

NO PIC	BRAND	PART #	DESCRIPTION	LINK
	PPI	B4F24SB	Flat Carrier Idler	link

BRAND	PART #	DESCRIPTION	LINK
PPI	B4FL24SB	Flat Carrier Idler	link

B4FL24SB



NO PIC	BRAND	PART #	DESCRIPTION	LINK
	PPI	B4FL20SB	Flat Carrier Idler	link

BRAND	PART #	DESCRIPTION	LINK
PPI	C620TE24SB	20 Degree Equal Troughing Idler	link

NO PIC

NO PIC	BRAND	PART #	DESCRIPTION	LINK
	PPI	C520TE30SB	20 Degree Equal Troughing Idler	link

BRAND	PART #	DESCRIPTION	LINK
PPI	C620TE30	Equal Impact Troughing Idler - 20 Degree for 30" Belt	link

NO PIC

C520TE36SB



BRAND	PART #	DESCRIPTION	LINK
PPI	C520TE36SB	20 Degree Equal Troughing Idler	link

BRAND	PART #	DESCRIPTION	LINK
PPI	C535TE24SB	35 Degree Equal Troughing Idler	link

NO PIC

PRECISION BATCH PLANT IDLERS

BRAND	PART #	DESCRIPTION	LINK
PPI	C535TE36SB	35 Degree Equal Troughing Idler	link

NO PIC

NO PIC	BRAND	PART #	DESCRIPTION	LINK
	PPI	B435TESA30SB	35 Degree Self-Aligner Equal Troughing Idler	link

BRAND	PART #	DESCRIPTION	LINK
PPI	B4RRD30SB	Return Rubber Disc	link

NO PIC

NO PIC	BRAND	PART #	DESCRIPTION	LINK
	PPI	B4RRD36SB	Return Rubber Disc	link

BRAND	PART #	DESCRIPTION	LINK
PPI	B4R18SB	Return Idler	link

B4R18SB



B4R24SB



BRAND	PART #	DESCRIPTION	LINK
PPI	B4R24SB	Return Idler	link

BRAND	PART #	DESCRIPTION	LINK
PPI	B5R24SB	Return Idler	link

B5R24SB



B4R30SB



BRAND	PART #	DESCRIPTION	LINK
PPI	B4R30SB	Return Idler	link

PRECISION BATCH PLANT IDLERS



B4R30SB1

BRAND	PART #	DESCRIPTION	LINK
PPI	B4R30SB1	Return Idler	link

BRAND	PART #	DESCRIPTION	LINK
PPI	B5R30SB	Return Idler	link



B5R30SB



B4R36SB

BRAND	PART #	DESCRIPTION	LINK
PPI	B4R36SB	Return Idler	link

BRAND	PART #	DESCRIPTION	LINK
PPI	B5R36SB	Return Idler	link



B5R36SB

NO PIC

BRAND	PART #	DESCRIPTION	LINK
PPI	B4R48SB	Return Idler	link

BRAND	PART #	DESCRIPTION	LINK
PPI	B5R48SB	Return Idler	link



B5R48SB

NO PIC

BRAND	PART #	DESCRIPTION	LINK
PPI	C520TEI36SB	20 Degree Equal Impact Troughing Idler	link

BRAND	PART #	DESCRIPTION	LINK
PPI	C4R24SB	Return Idler	link

NO PIC

PRECISION BATCH PLANT IDLERS

BRAND	PART #	DESCRIPTION	LINK
PPI	C6R24SB	Return Idler	link

NO PIC

BRAND	PART #	DESCRIPTION	LINK
PPI	C4R30SB	Return Idler	link

C4R30SB



NO PIC

BRAND	PART #	DESCRIPTION	LINK
PPI	C6R30SB	Return Idler	link

BRAND	PART #	DESCRIPTION	LINK
PPI	C4R36SB	Return Idler	link

C4R36SB



BRAND	PART #	DESCRIPTION	LINK
PPI	C5R36SB	Return Idler	link

NO PIC

NO PIC

BRAND	PART #	DESCRIPTION	LINK
PPI	C6R36SB	Return Idler	link

PRECISION BATCH PLANT IDLERS

NO PIC

BRAND	PART #	DESCRIPTION	LINK
PPI	C6R48SB	Return Idler	link

BRAND	PART #	DESCRIPTION	LINK
PPI	C5RSA30SB	Return Self Aligner	link



NO PIC

BRAND	PART #	DESCRIPTION	LINK
PPI	D520TE30SB	20 Degree Equal Troughing Idler	link

BRAND	PART #	DESCRIPTION	LINK
PPI	GRF	Flat Guideroll Assembly	link

NO PIC



BRAND	PART #	DESCRIPTION	LINK
PPI	MS4	Speed Switch	link

BRAND	PART #	DESCRIPTION	LINK
PPI	MS4	Speed Switch	link

NO PIC

NO PIC

BRAND	PART #	DESCRIPTION	LINK
PPI	B5TE18SB	Equal Troughing Idler	link

PRECISION BATCH PLANT IDLERS

B4TE24SB

BRAND	PART #	DESCRIPTION	LINK
PPI	B4TE24SB	Equal Troughing Idler	link



B4TE30SB

BRAND	PART #	DESCRIPTION	LINK
PPI	B4TE30SB	Equal Troughing Idler	link



B5TE30SB

BRAND	PART #	DESCRIPTION	LINK
PPI	B5TE30SB	Equal Troughing Idler	link



NO PIC

BRAND	PART #	DESCRIPTION	LINK
PPI	B4FL20SB	Flat Carrier Idler	link

BRAND	PART #	DESCRIPTION	LINK
PPI	B4FL48SB	Flat Carrier Idler	link



20430



BRAND	PART #	DESCRIPTION	LINK
PPI	20430	3.5in Drop Idler Brackets	link

BRAND	PART #	DESCRIPTION	LINK
PPI	C5FL30SB	Self Aligning Return Idler	link

C5FL30SB



NO PIC

BRAND	PART #	DESCRIPTION	LINK
PPI	C4R24PL	Return Idler	link

NO PIC

BRAND	PART #	DESCRIPTION	LINK
PPI	E6TE78SB	Troughing Idler Roller	link

BRAND	PART #	DESCRIPTION	LINK
PPI	42815	Slotted Shaft Adapter Nut	link



Lagging For Drum Conveyor Pulleys

PPI has complete in-house pulley lagging capabilities. Every step of the pulley manufacturing and lagging process is controlled internally, which assures quality, prompt delivery and competitive pricing of lagged pulleys. Available in a wide variety of styles and thicknesses. Lagging is primarily used to improve traction capacity, resist abrasive conditions and extend pulley and belt life. The style of lagging required is usually influenced by operating conditions. While the standard is 60 durometer, it is available in various durometers, with 45 and 70 being common alternates. SBR is standard; Neoprene and MSHA are available as well as a wide variety of other compounds.

Other lagging is available for specific applications. An example of this is rougtop lagging. This is used for small diameter drive pulleys. It is created by lagging the pulley, but before the rubber is cured, a special mold is applied to cause the grooves to be formed in the lagging. It is then cured with this form in place. It gives excellent traction, without cutting grooves. By forming the groove in the lagging, PPI can offer rougtop on thin lagging, such as 1/4".

Drum Lagging Options



Ordering Guide: Superior Idlers

Superior makes ordering easy with a simple number and letter system so you can easily jot down the idlers you need and relay them to our sales staff. Superior manufactures many different styles of CEMA B, C, D, E, and F idlers along with a full line of CB-504 style bearing idlers and rollers. Simply follow the procedure below and you'll be on your way to placing an accurate order.

C5-35 E-36-MOX-TTM

CEMA RATING

(or Series) - Specify either CEMA B, C, D, E, or F.

ROLL DIAMETER

Specify either 4, 5, 6, 7, or 8 for the corresponding roll size diameter.

TROUGHING ANGLE

Troughing angle - Specify either 20, 35, or 45 for the corresponding troughing angle. V-return - Specify either 10 or 15 for the corresponding troughing angle. For standard return and life shaft products disregard the angle.

IDLER TYPE LETTER

Specify the idler identification letter for the particular idler you may need from the list on the right.

BELT WIDTH

Specify either 18, 24, 30, 36, 42, 48, 54, 60, 72, 84, 96, 108, or 120 depending on your CEMA rating.

ROLL STYLE

Specify either "MOX" for Moxie Rolls, "DT" for Double-Tube Idler, or "DX" for DX Idler.

SEAL STYLE

Specify either "WET" for Wet Seal, "DRY" for Dry Seal, "ECO" for Eco Seal, or "TTM" for Titanium Seal.

IDLER TYPE LIST

E	Troughing Idler Equal Length Rolls
EA	Self-Aligning Troughing Idler
BA	Bi-Directional Aligning Troughing Idler
EI	Rubber Cushion Troughing Idler
GO	Offset Troughing Idler
GOI	Rubber Cushion Offset Troughing Idler
U	Troughing Idler Unequal Length Rolls
UI	Rubber Cushion Troughing Idler Unequal Length Rolls
P	Feeder / Picking Idler
PI	Rubber Cushion Feeder / Picking Idler
RET	Return Idler
FLT	Flat Carrier Idler
RETA	Retuen Self-Aligning Idler
RETI	Return Rubber Cushion Idler
FLTI	Flat Carrier Rubber Cushion Idler
CM	Low-Profile Channel Mount Idler
CMI	Channel Mount Impact Low Profile Idler
SM	Low-Profile Standard Mount Idler
SMI	Standard Mount Impact Low Profile Idler
RETAI	Return Self-Aligning Rubber Lagged Cushion Idler
EW	Wire Rope Idler
EWI	Rubber Cushion Wire Rope Idler
VPE	Variable Pitch Idler
VPEI	Rubber Cushion Variable Pitch Idler
RETU	Urathon Return
RETSUP	Spiral Urathon Return
RETV	V-Return Idler
RETVI	Rubber Cushion V-Return Idler
IVR	Inverted V-Return Idler
CMP	Low-Profile Channel Mount Feeder / Picking Idler
CMPI	Rubber Cushion Low-Profile Channel Mount Feeder / Picking Idler
IM	Low-Profile Inboard Mount Idler
IMI	Rubber Cushion Low-Profile Inboard Mount Idler
SO	Underground Box Frame Odler
SB	Underground Single Beam Idler
MOX	Moxie Roll (i.e. C5-35E-30MOX)
LS	Live Shaft Roller (i.e. LS-536)
LSI	Rubber Cushion Live Shaft Roller (i.e. LSI-548)
LSB	Live Shaft Beater (i.e. LSB-530-107)



BRAND	PART #	DESCRIPTION	LINK
Superior	B420E14	4in Troughing Idler Roller	link

BRAND	PART #	DESCRIPTION	LINK
Superior	B520E18	5in Troughing Idler Roller	link

no pic



BRAND	PART #	DESCRIPTION	LINK
Superior	B420E24	4in Troughing Idler Roller	link

BRAND	PART #	DESCRIPTION	LINK
Superior	B520E24	5in Troughing Idler Roller	link



BRAND	PART #	DESCRIPTION	LINK
Superior	B420E30	4in Troughing Idler Roller	link

BRAND	PART #	DESCRIPTION	LINK
Superior	B520E30	5in Troughing Idler Roller	link



BRAND	PART #	DESCRIPTION	LINK
Superior	B420E36	4in Troughing Idler Roller	link



BRAND	PART #	DESCRIPTION	LINK
Superior	B520E36	5in Troughing Idler Roller	link











no pic

BRAND	PART #	DESCRIPTION	LINK
Superior	B420E42	4in Troughing Idler Roller	link

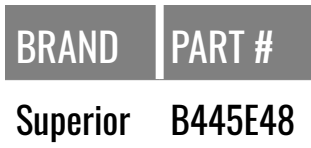





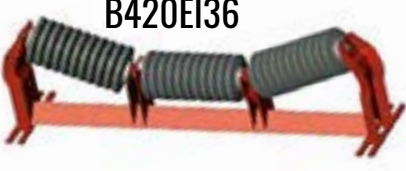

SUPERIOR BATCH PLANT IDLERS

	B420E48	BRAND	PART #	DESCRIPTION	LINK
		Superior	B420E48	4in Troughing Idler Roller	link
BRAND	PART #	DESCRIPTION	LINK		B520E48
Superior	B520E48	5in Troughing Idler Roller	link		
	B435E18	BRAND	PART #	DESCRIPTION	LINK
		Superior	B435E18	4in Troughing Idler Roller	link
BRAND	PART #	DESCRIPTION	LINK		B435E24
Superior	B435E24	4in Troughing Idler Roller	link		
	B535E24	BRAND	PART #	DESCRIPTION	LINK
		Superior	B535E24	5in Troughing Idler Roller	link
BRAND	PART #	DESCRIPTION	LINK		B435E30
Superior	B435E30	4in Troughing Idler Roller	link		
	B535E30	BRAND	PART #	DESCRIPTION	LINK
		Superior	B535E30	5in Troughing Idler Roller	link
BRAND	PART #	DESCRIPTION	LINK		B435E36
Superior	B435E36	4in Troughing Idler Roller	link		
	B535E36	BRAND	PART #	DESCRIPTION	LINK
		Superior	B535E36	5in Troughing Idler Roller	link
BRAND	PART #	DESCRIPTION	LINK		
Superior	B435E42	4in Troughing Idler Roller	link	no pic	





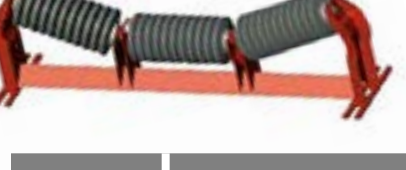

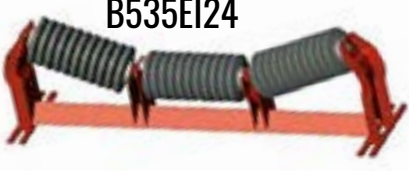

SUPERIOR BATCH PLANT IDLERS

BRAND	PART #	DESCRIPTION	LINK		B435E48
Superior	B435E48	4in Troughing Idler Roller	link		
	B535E48	BRAND	PART #	DESCRIPTION	LINK
		Superior	B535E48	5in Troughing Idler Roller	link
BRAND	PART #	DESCRIPTION	LINK		
Superior	B445E30	5in Troughing Idler Roller	link	no pic	
BRAND	PART #	DESCRIPTION	LINK		B445E48
no pic		Superior	B445E48	4in Troughing Idler Roller	link
BRAND	PART #	DESCRIPTION	LINK		B420E18
Superior	B420E18	4in Rubber Cushion Impact Troughing Idler	link		
	B520E18	BRAND	PART #	DESCRIPTION	LINK
		Superior	B520E18	5in Rubber Cushion Impact Troughing Idler	link
BRAND	PART #	DESCRIPTION	LINK		B420E24
Superior	B420E24	4in Rubber Cushion Impact Troughing Idler	link		
	B520E24	BRAND	PART #	DESCRIPTION	LINK
		Superior	B520E24	5in Rubber Cushion Impact Troughing Idler	link
BRAND	PART #	DESCRIPTION	LINK		B420E30
Superior	B420E30	4in Rubber Cushion Impact Troughing Idler	link		

SUPERIOR BATCH PLANT IDLERS

BRAND	PART #	DESCRIPTION	LINK	
Superior	B520EI30	5in Rubber Cushion Impact Troughing Idler	link	
				
BRAND	PART #	DESCRIPTION	LINK	
Superior	B420EI36	4in Rubber Cushion Impact Troughing Idler	link	
				
BRAND	PART #	DESCRIPTION	LINK	
Superior	B520EI36	5in Rubber Cushion Impact Troughing Idler	link	
				
BRAND	PART #	DESCRIPTION	LINK	
Superior	B420EI42	4in Rubber Cushion Impact Troughing Idler	link	
				
BRAND	PART #	DESCRIPTION	LINK	
Superior	B520EI42	5in Rubber Cushion Impact Troughing Idler	link	
				
BRAND	PART #	DESCRIPTION	LINK	
Superior	B420EI48	4in Rubber Cushion Impact Troughing Idler	link	
				
BRAND	PART #	DESCRIPTION	LINK	
Superior	B520EI48	5in Rubber Cushion Impact Troughing Idler	link	
				
BRAND	PART #	DESCRIPTION	LINK	
Superior	B435EI18	4in Rubber Cushion Impact Troughing Idler	link	
				
BRAND	PART #	DESCRIPTION	LINK	
Superior	B535EI18	5in Rubber Cushion Impact Troughing Idler	link	

SUPERIOR BATCH PLANT IDLERS

BRAND	PART #	DESCRIPTION	LINK	
Superior	B435EI24	5in Rubber Cushion Impact Troughing Idler	link	
				
BRAND	PART #	DESCRIPTION	LINK	
Superior	B535EI24	4in Rubber Cushion Impact Troughing Idler	link	
				
BRAND	PART #	DESCRIPTION	LINK	
Superior	B435EI30	5in Rubber Cushion Impact Troughing Idler	link	
				
BRAND	PART #	DESCRIPTION	LINK	
Superior	B535EI30	4in Rubber Cushion Impact Troughing Idler	link	
				
BRAND	PART #	DESCRIPTION	LINK	
Superior	B435EI36	5in Rubber Cushion Impact Troughing Idler	link	
				
BRAND	PART #	DESCRIPTION	LINK	
Superior	B535EI36	4in Rubber Cushion Impact Troughing Idler	link	
				
BRAND	PART #	DESCRIPTION	LINK	
Superior	B435EI42	5in Rubber Cushion Impact Troughing Idler	link	
				
BRAND	PART #	DESCRIPTION	LINK	
Superior	B535EI42	4in Rubber Cushion Impact Troughing Idler	link	
				
BRAND	PART #	DESCRIPTION	LINK	
Superior	B435EI48	5in Rubber Cushion Impact Troughing Idler	link	

SUPERIOR BATCH PLANT IDLERS

BRAND	PART #	DESCRIPTION	LINK
-------	--------	-------------	------

Superior B535EI48 5in Rubber Cushion Impact Troughing Idler [link](#)



B535EI48



B4RET18

BRAND	PART #	DESCRIPTION	LINK
-------	--------	-------------	------

Superior B4RET18 4in Return Idler [link](#)

BRAND	PART #	DESCRIPTION	LINK
-------	--------	-------------	------

Superior B4RET24 4in Return Idler [link](#)

B4RET18



B5RET24

BRAND	PART #	DESCRIPTION	LINK
-------	--------	-------------	------

Superior B5RET24 5in Return Idler [link](#)

BRAND	PART #	DESCRIPTION	LINK
-------	--------	-------------	------

Superior B4RET30 4in Return Idler [link](#)

B4RET30



B5RET30

BRAND	PART #	DESCRIPTION	LINK
-------	--------	-------------	------

Superior B5RET30 5in Return Idler [link](#)

BRAND	PART #	DESCRIPTION	LINK
-------	--------	-------------	------

Superior B4RET36 4in Return Idler [link](#)

B4RET36



B5RET36

BRAND	PART #	DESCRIPTION	LINK
-------	--------	-------------	------

Superior B5RET36 5in Return Idler [link](#)

BRAND	PART #	DESCRIPTION	LINK
-------	--------	-------------	------

Superior B4RET48 4in Return Idler [link](#)

no pic



B5RET48

BRAND	PART #	DESCRIPTION	LINK
-------	--------	-------------	------

Superior B5RET48 5in Return Idler [link](#)

SUPERIOR BATCH PLANT IDLERS

BRAND	PART #	DESCRIPTION	LINK
-------	--------	-------------	------

Superior CB45RET24 4in Return Idler [link](#)



CB45RET24

no pic

BRAND	PART #	DESCRIPTION	LINK
-------	--------	-------------	------

Superior B5RET130 5in Rubber Cushion Return Idler [link](#)

BRAND	PART #	DESCRIPTION	LINK
-------	--------	-------------	------

Superior B420EA24 4in Self-Aligning Troughing Idler [link](#)



B420EA24

no pic

BRAND	PART #	DESCRIPTION	LINK
-------	--------	-------------	------

Superior B520EA30 5in Self-Aligning Troughing Idler [link](#)

BRAND	PART #	DESCRIPTION	LINK
-------	--------	-------------	------

Superior B435EA24 4in Self-Aligning Troughing Idler [link](#)

no pic



B435EA30

BRAND	PART #	DESCRIPTION	LINK
-------	--------	-------------	------

Superior B435EA30 4in Self-Aligning Troughing Idler [link](#)

BRAND	PART #	DESCRIPTION	LINK
-------	--------	-------------	------

Superior B535EA30 5in Self-Aligning Troughing Idler [link](#)

no pic



B435EA36

BRAND	PART #	DESCRIPTION	LINK
-------	--------	-------------	------





Superior B435EA36 4in Self-Aligning Troughing Idler [link](#)

BRAND	PART #	DESCRIPTION	LINK
-------	--------	-------------	------



Superior B535EA36 5in Self-Aligning Troughing Idler [link](#)

no pic

SUPERIOR BATCH PLANT IDLERS

BRAND	PART #	DESCRIPTION	LINK
no pic	Superior B535EA48	5in Self-Aligning Troughing Idler	link
Superior B445EA36	4in Self-Aligning Troughing Idler	link	no pic
no pic	Superior B545EA36	5in Self-Aligning Troughing Idler	link
Superior B545EA42	5in Self-Aligning Troughing Idler	link	no pic
	Superior B4RETA24	4in Self-Aligning Return Idler	link
Superior B5RETA24	5in Self-Aligning Return Idler	link	no pic
	Superior B4RETA30	4in Self-Aligning Return Idler	link
Superior B5RETA30	5in Self-Aligning Return Idler	link	
	Superior B4RETA36	4in Self-Aligning Return Idler	link

SUPERIOR BATCH PLANT IDLERS

BRAND	PART #	DESCRIPTION	LINK
Superior B5RETA36	5in Self-Aligning Return Idler	link	
no pic	Superior B4RETA48	4in Self-Aligning Return Idler	link
Superior B5RETA48	5in Self-Aligning Return Idler	link	
no pic	Superior C435E30	4in Troughing Idler (Equal Length Roller)	link
Superior C435E36	4in Troughing Idler (Equal Length Roller)	link	no pic
no pic	Superior C520E24	5in Troughing Idler (Equal Length Roller)	link
Superior C520E30	5in Troughing Idler (Equal Length Roller)	link	no pic
	Superior C520E36	5in Troughing Idler (Equal Length Roller)	link
Superior C520E42	5in Troughing Idler (Equal Length Roller)	link	no pic

SUPERIOR BATCH PLANT IDLERS

no pic	BRAND	PART #	DESCRIPTION	LINK
	Superior	C535E24	5in Troughing Idler (Equal Length Roller)	link
	BRAND	PART #	DESCRIPTION	LINK
	Superior	C535E30	5in Troughing Idler (Equal Length Roller)	link
	no pic			
	BRAND	PART #	DESCRIPTION	LINK
	Superior	C535E36	5in Troughing Idler (Equal Length Roller)	link
	no pic			
	BRAND	PART #	DESCRIPTION	LINK
	Superior	C535E42	5in Troughing Idler (Equal Length Roller)	link
	no pic			
	BRAND	PART #	DESCRIPTION	LINK
	Superior	C535E48	5in Troughing Idler (Equal Length Roller)	link
	no pic			
	BRAND	PART #	DESCRIPTION	LINK
	Superior	C545E48	5in Troughing Idler (Equal Length Roller)	link
	no pic			
	BRAND	PART #	DESCRIPTION	LINK
	Superior	C520EI54	5in Rubber Cushion Impact Troughing Idler	link
	no pic			
	BRAND	PART #	DESCRIPTION	LINK
	Superior	C535EI42	5in Rubber Cushion Impact Troughing Idler	link
	no pic			
	BRAND	PART #	DESCRIPTION	LINK
	Superior	C4RET24	4in Return Idler	link

SUPERIOR BATCH PLANT IDLERS

BRAND	PART #	DESCRIPTION	LINK	no pic
Superior	C6RET24	6in Return Idler	link	
	C4RET30			
	BRAND	PART #	DESCRIPTION	LINK
	Superior	C4RET30	4in Return Idler	link
	BRAND	PART #	DESCRIPTION	LINK
	Superior	C5RET30	5in Return Idler	link
	no pic			
	BRAND	PART #	DESCRIPTION	LINK
	Superior	C6RET30	6in Return Idler	link
	BRAND	PART #	DESCRIPTION	LINK
	Superior	C4RET36	4in Return Idler	link
	no pic			
	BRAND	PART #	DESCRIPTION	LINK
	Superior	C5RET36	5in Return Idler	link
	BRAND	PART #	DESCRIPTION	LINK
	Superior	C6RET36	6in Return Idler	link
	no pic			
	BRAND	PART #	DESCRIPTION	LINK
	Superior	C5RET42	5in Return Idler	link
	BRAND	PART #	DESCRIPTION	LINK
	Superior	C6RET48	6in Return Idler	link
	no pic			
	BRAND	PART #	DESCRIPTION	LINK
	Superior	C535EA30	5in Self-Aligning Troughing Idler	link

SUPERIOR BATCH PLANT IDLERS

no pic

BRAND	PART #	DESCRIPTION	LINK
Superior	C535EA36	5in Self-Aligning Troughing Idler	link

BRAND	PART #	DESCRIPTION	LINK
Superior	C545EA54	5in Self-Aligning Troughing Idler	link

no pic



C4RETA24

BRAND	PART #	DESCRIPTION	LINK
Superior	C4RETA24	4in Self-Aligning Return Idler	link

BRAND	PART #	DESCRIPTION	LINK
Superior	C5RETA24	5in Self-Aligning Return Idler	link



C5RETA24



C4RETA30

BRAND	PART #	DESCRIPTION	LINK
Superior	C4RETA30	4in Self-Aligning Return Idler	link

BRAND	PART #	DESCRIPTION	LINK
Superior	C5RETA30	5in Self-Aligning Return Idler	link



C5RETA30



BRAND	PART #	DESCRIPTION	LINK
Superior	C4RETA36	4in Self-Aligning Return Idler	link

BRAND	PART #	DESCRIPTION	LINK
Superior	C5RETA36	5in Self-Aligning Return Idler	link



C5RETA36



C4RETA48

BRAND	PART #	DESCRIPTION	LINK
Superior	C4RETA48	4in Self-Aligning Return Idler	link

SUPERIOR BATCH PLANT IDLERS



C5RETA48

BRAND	PART #	DESCRIPTION	LINK
Superior	C5RETA48	5in Self-Aligning Return Idler	link

no pic

BRAND	PART #	DESCRIPTION	LINK
Superior	D520E30	5in Troughing Idler	link

BRAND	PART #	DESCRIPTION	LINK
Superior	B416	4in Cema B Replacement Idler Rolls	link

no pic



B424

BRAND	PART #	DESCRIPTION	LINK
Superior	B424	4in Cema B Replacement Idler Rolls	link

BRAND	PART #	DESCRIPTION	LINK
Superior	B524	5in Cema B Replacement Idler Rolls	link

no pic



B430

BRAND	PART #	DESCRIPTION	LINK
Superior	B430	4in Cema B Replacement Idler Rolls	link

BRAND	PART #	DESCRIPTION	LINK
Superior	B530	5in Cema B Replacement Idler Rolls	link

no pic



B436

BRAND	PART #	DESCRIPTION	LINK
Superior	B436	Cema B Replacement Idler Rolls	link

BRAND	PART #	DESCRIPTION	LINK
Superior	B536	5in Cema B Replacement Idler Rolls	link

no pic

SUPERIOR BATCH PLANT IDLERS

BRAND	PART #	DESCRIPTION	LINK
Superior	B448	4in Cema B Replacement Idler Rolls	link



B448

no pic

BRAND	PART #	DESCRIPTION	LINK
Superior	B548	5in Cema B Replacement Idler Rolls	link

BRAND	PART #	DESCRIPTION	LINK
Superior	B4E130	4in Cema B Replacement Idler Rolls	link

no pic

no pic

BRAND	PART #	DESCRIPTION	LINK
Superior	B5E130	5in Cema B Replacement Idler Rolls	link

BRAND	PART #	DESCRIPTION	LINK
Superior	B4E136	4in Cema B Replacement Idler Rolls	link

no pic

B4240100



BRAND	PART #	DESCRIPTION	LINK
Superior	B4240100	4in Cema B Replacement Idler Rolls	link

B4300500



BRAND	PART #	DESCRIPTION	LINK
Superior	B4300500	4in Cema B Replacement Idler Rolls	link

C418



BRAND	PART #	DESCRIPTION	LINK
Superior	C418	4in Cema C Replacement Idler Rolls	link

BRAND	PART #	DESCRIPTION	LINK
Superior	C424	4in Cema C Replacement Idler Rolls	link

C424



SUPERIOR BATCH PLANT IDLERS

BRAND	PART #	DESCRIPTION	LINK
Superior	C524	5in Cema C Replacement Idler Rolls	link



C524

C430



BRAND	PART #	DESCRIPTION	LINK
Superior	C430	4in Cema C Replacement Idler Rolls	link

BRAND	PART #	DESCRIPTION	LINK
Superior	C530	5in Cema C Replacement Idler Rolls	link



C530

no pic

BRAND	PART #	DESCRIPTION	LINK
Superior	C630	6in Cema C Replacement Idler Rolls	link

BRAND	PART #	DESCRIPTION	LINK
Superior	C436	4in Cema C Replacement Idler Rolls	link



C436



C536

BRAND	PART #	DESCRIPTION	LINK
Superior	C536	5in Cema C Replacement Idler Rolls	link

BRAND	PART #	DESCRIPTION	LINK
Superior	C542	5in Cema C Replacement Idler Rolls	link



C542



C448

BRAND	PART #	DESCRIPTION	LINK
Superior	C448	4in Cema C Replacement Idler Rolls	link



BRAND	PART #	DESCRIPTION	LINK
Superior	C548	5in Cema C Replacement Idler Rolls	link



C548





SUPERIOR BATCH PLANT IDLERS

11 IDLERS

no pic	BRAND	PART #	DESCRIPTION	LINK
	Superior	C554	5in Cema C Replacement Idler Rolls	link
	BRAND	PART #	DESCRIPTION	LINK
	Superior	CB04028	4in Cema C Replacement Idler Rolls	link
1301412			CB04028	
	BRAND	PART #	DESCRIPTION	LINK
	Superior	1301412	Hex Adapter Nut	link
	BRAND	PART #	DESCRIPTION	LINK
	Superior	09105225	Cema C Rubber Disc - 5in OD x 2.25in ID	link
			no pic	
no pic	BRAND	PART #	DESCRIPTION	LINK
	Superior	LS536	Live Shaft Roll	link
	BRAND	PART #	DESCRIPTION	LINK
	Superior	42404475	4in Stub Roller	link
			no pic	
no pic	BRAND	PART #	DESCRIPTION	LINK
	Superior	32000019	4.25in Slotted Rise Bracket	link
	BRAND	PART #	DESCRIPTION	LINK
	Superior	32000017	Conveyor Return Idler 4.5in Drop Bracket	link
32000018			32000017	
	BRAND	PART #	DESCRIPTION	LINK
	Superior	32000018	Conveyor Return Idler 1.5in Drop Bracket	link
	BRAND	PART #	DESCRIPTION	LINK
	Superior	32000021	Conveyor Return Idler 4.5in Drop Bracket - Universal	link
			32000018	
				

SUPERIOR BATCH PLANT IDLERS

11 IDLERS

BRAND	PART #	DESCRIPTION	LINK	
Superior	1310076	Idler Clip Kit	link	
			1310076	
	BRAND	PART #	DESCRIPTION	LINK
no pic	Superior	1310052	Idler Clip Kit	link
	BRAND	PART #	DESCRIPTION	LINK
	Superior	41541250	Single Pin	link
			41541250	
				
no pic	BRAND	PART #	DESCRIPTION	LINK
	Superior	32000412	Return Idler 4.25in Hex Rise Bracket	link
	BRAND	PART #	DESCRIPTION	LINK
	Superior	32014046	Return Idler 4.5in Hex Drop Bracket	link
			32014046	
				
	BRAND	PART #	DESCRIPTION	LINK
	Superior	32410450	Bracket	link
			32410450	
				
	BRAND	PART #	DESCRIPTION	LINK
	Superior	DCEMA1432CFXT30	14in Diameter Drum Head Pulley	link
			DCEMA1432CFXT30	
				
	BRAND	PART #	DESCRIPTION	LINK
	Superior	DCEMA832CFXT30	Smooth Take Up Pulley	link
			DCEMA832CFXT30	
				
	BRAND	PART #	DESCRIPTION	LINK
	Superior	DCEMA1232CFXT30	Smooth Take Up Pulley	link
			DCEMA1232CFXT30	
				

Drum Pulley Product Range

	CEMA DUTY	MINE DUTY		SUPER DUTY
		PRIME PULLEY	MINE DUTY	
Drum Pulleys				
Belt Style	Fabric	Fabric	Fabric	Fabric
Belt Burden	No Load	Full Load	Full Load	Full Load
Starts and Stops	Infrequent	Frequent	Frequent	Frequent
Belt/ Feed Characteristics	Uniformly Loaded	Non-Uniformly Loaded	Non-Uniformly Loaded	Non-Uniformly Loaded

Drum Pulleys

CEMA DUTY	PRIME MINE DUTY	MINE DUTY 2.0	SUPER DUTY
			
Diameter: 8in to 60in	Diameter: 8in to 30in	Diameter: 8in to 30in	Diameter: 8in to 30in
Standard Face Widths: 12in to 78in	Integral Hib Diameter: Up to 30in and XT70 Standard Face Widths: 12in to 78in	Integral Hib Diameter: Up to 30in and XT70 Standard Face Widths: 12in to 78in	Integral Hib Diameter: Up to 30in and XT70 Standard Face Widths: 12in to 78in



0300120

BRAND	PART #	DESCRIPTION	LINK
Superior	0300120	Pillow Block	link

XT and QD Bushing Specs

BUSHING	BORE	BUSHING KEYWAY	SHAFT KEYWAY	WEIGHT*
XT15	5/8 - 7/8	3/16 x 3/32	3/16 x 3/32	1.1
	15/16 - 1-1/4	1/4 x 1/8	1/4 x 1/8	1.1
	1-5/16 - 1-3/8	5/16 x 5/32	5/16 x 5/32	1.1
	1-7/16 - 1-1/2	3/8 x 1/8	3/8 x 3/16	1.1
XT20	3/4 - 7/8	3/16 x 3/32	3/16 x 3/32	2.1
	15/16 - 1-1/4	1/4 x 1/8	1/4 x 1/8	2.1
	1-5/16 - 1-3/8	5/16 x 5/32	5/16 x 5/32	2.1
	1-7/16 - 1-3/4	3/8 x 3/16	3/8 x 3/16	2.1
XT25	1-3/16 - 2	1/2 x 3/16	1/2 x 1/4	2.1
	1 - 1-1/4	1/4 x 1/8	1/4 x 1/8	3.5
	1-5/16 - 1-3/8	5/16 x 5/32	5/16 x 5/32	3.5
	1-7/16 - 1-3/4	3/8 x 3/16	3/8 x 3/16	3.5
XT30	1-13/16 - 2-1/4	1/2 x 1/4	1/2 x 1/4	3.5
	2-5/16 - 2-1/2	5/8 x 1/8	5/8 x 5/16	3.5
	1-7/16 - 1-3/4	3/8 x 3/16	3/8 x 3/16	6.2
	1-13/16 - 2-1/4	1/2 x 1/4	1/2 x 1/4	6.2
XT35	2-5/16 - 2-3/4	5/8 x 5/16	5/8 x 5/16	6.2
	2-13/16	3/4 x 3/8	3/4 x 3/8	6.2
	2-7/8 - 3	3/4 x 3/16	3/4 x 3/8	6.2
	1-15/16 - 2-1/4	1/2 x 1/4	1/2 x 1/4	10.4
XT35	2-5/16 - 2-3/4	5/8 x 5/16	5/8 x 5/16	10.4
	2-13/16 - 3-1/4	3/4 x 3/8	3/4 x 3/8	10.4
	3-5/16 - 3-3/8	7/8 x 7/16	7/8 x 7/16	10.4
	3-7/16 - 3-1/2	7/8 x 5/16	7/8 x 7/16	10.4

XT and QD Bushing Specs Cont.

BUSHING	BORE	BUSHING KEYWAY	SHAFT KEYWAY	WEIGHT*
XT40	2-7/16 - 2-3/4	5/8 x 5/16	5/8 x 5/16	13.3
	2-13/16 - 3-1/4	3/4 x 3/8	3/4 x 3/8	13.3
	3-5/16 - 3-3/4	7/8 x 7/16	7/8 x 7/16	13.3
	3-13/16	1 x 1/2	1 x 1/2	13.3
	3-7/8 - 4	1 x 3/8	1 x 1/2	13.3
XT45	3-7/16 - 3-3/4	7/8 x 7/16	7/8 x 7/16	18.5
	3-13/16 - 4-15/16	1 x 1/2	1 x 1/2	18.5
	2-13/16 - 3-1/4	1 x 3/8	1 x 1/2	18.5
XT50	3-15/16 - 4-1/2	1 x 1/2	1 x 1/2	35.5
	4-9/16 - 5	1-1/4 x 5/8	1-1/4 x 5/8	35.5
XT60	4-15/16 - 5-1/2	1-1/4 x 5/8	1-1/4 x 5/8	48
	5-9/16 - 6	1-1/2 x 3/4	1-1/2 x 3/4	48
XT70	5-5/16 - 5-1/2	1-1/4 x 5/8	1-1/4 x 5/8	74.6
	5-9/16 - 6-1/2	1-1/2 x 3/4	1-1/2 x 3/4	74.6
	6-9/16 - 7	1-3/4 x 3/4	1-3/4 x 3/4	74.6
XT80	6-15/16 - 7-1/2	1-1/4 x 5/8	1-1/4 x 5/8	96.6
	5-9/16 - 6	1-1/2 x 3/4	1-1/2 x 3/4	96.6
XT100	8-1/2, 9	2 x 3/4	2-3/4	146
	9-7/16, 9-1/2, 10	2-1/2 x 7/8	2-1/2 x 7/8	146
XT120	10-1/2, 11	2-1/2 x 7/8	2-1/2 x 7/8	216
	11-1/2, 12	3 x 1	3 x 1	216

BUSHING	BORE	BUSHING KEYWAY	SHAFT KEYWAY	WEIGHT*
SF	1/2 - 9/16	1/8 x 1/16	1/8 x 1/16	4
	5/8 - 7/8	3/16 x 3/32	3/16 x 3/32	4
	15/16 - 1-1/4	1/4 x 1/8	1/4 x 1/8	4
	1-5/16 - 1-3/8	5/16 x 5/32	5/16 x 5/32	4
	1-7/16 - 1-1-3/4	3/8 x 3/16	3/8 x 3/16	4
	1-13/16 - 2-1/4	1/2 x 1/4	1/2 x 1/4	4
	2-5/16	5/8 x 5/16	5/8 x 5/16	4
	2-3/8 - 2-1/2	5/8 x 3/16	5/8 x 5/16	4
	1 - 1-3/8	5/16 x 5/32	5/16 x 5/32	8.7
	1-7/16 - 1-3/4	3/8 x 3/16	3/8 x 3/16	8.7
E	1-13/16 - 2-1/4	1/2 x 1/4	1/2 x 1/4	8.7
	2-5/16 - 2-3/4	5/8 x 5/16	5/8 x 5/16	8.7
	2-13/16 - 2-7/8	3/4 x 3/8	3/4 x 3/8	8.7
	2-15/16	3/4 x 1/8	3/4 x 3/8	8.7
	1-13/16 - 2-1/4	1/2 x 1/4	1/2 x 1/4	13
F	2-5/16 - 2-3/4	5/8 x 5/16	5/8 x 5/16	13
	2-13/16 - 3-1/4	3/4 x 3/8	3/4 x 3/8	13
	3-5/16 - 3-7/16	7/8 x 3/16	7/8 x 7/16	13
JS	2-13/16 - 3-1/4	3/4 x 3/8	3/4 x 3/8	17.8
	3-5/16 - 3-3/4	7/8 x 7/16	7/8 x 7/16	17.8
	3-13/16	1 x 1/8	1 x 1/2	17.8
	3-7/8 - 4	1 x 1/8	1 x 1/2	17.8
MS	2-13/16 - 3-1/4	3/4 x 3/8	3/4 x 3/8	44.2
	3-5/16 - 3-3/4	7/8 x 7/16	7/8 x 7/16	44.2
	3-13/16 - 4-9/16	1 x 1/2	1 x 1/2	44.2
	4-11/16 - 4-3/4	1-1/4 x 5/8	1-1/4 x 5/8	44.2

XT and QD Bushing Specs Cont.

BUSHING	BORE	BUSHING KEYWAY	SHAFT KEYWAY	WEIGHT*
NS	3-5/16 - 3-3/4	7/8 x 7/16	v7/8 x 7/16	52.7
	3-13/16 - 4-1/2	1 x 1/2	1 x 1/2	52.7
	4-3/4 - 5-1/2	1-1/4 X 5/8	1-1/4 X 5/8	52.7
PS	3-15/16 - 4-1/2	1 X 1/2	1 X 1/2	84.1
	4-3/4 - 5-1/2	1-1/4 - 5/8	1-1/4 - 5/8	84.1
	5-15/16	2 x 1/4	2 x 3/4	84.1
WS	5-3/4 - 6-1/2	1-1/2 x 3/4	1-1/2 x 3/4	183
	7 - 7-1/2	1-3/4 x 3/4	1-3/4 x 3/4	183
	8	2 x 1/4	2 x 3/4	183



0200023

BRAND	PART #	DESCRIPTION	LINK
Superior	0200023	Bushing for Conveyor Pulleys with 1-7/16 Shaft Diameter	link

BRAND	PART #	DESCRIPTION	LINK
-------	--------	-------------	------

Superior 0200025 XT25 Bushing for Conveyor Pulleys [link](#) no pic

0200029



BRAND	PART #	DESCRIPTION	LINK
Superior	0200029	XT25 Bushing	link

BRAND	PART #	DESCRIPTION	LINK
-------	--------	-------------	------

Superior 0200033 XT30 Bushing [link](#)



0200033

BRAND	PART #	DESCRIPTION	LINK
-------	--------	-------------	------

0200036



Superior 0200036 Bushing [link](#)

Exterra Primary Belt Cleaner

BRAND	PART #	DESCRIPTION	LINK
Superior	0700542	22in Urethane Belt Scraper Wiper Blade	link



0700542



P2420541

BRAND	PART #	DESCRIPTION	LINK
Superior	P2420541	Primary Belt Cleaner Scraper Wiper Assembly for 24in Belt Widths	link

BRAND	PART #	DESCRIPTION	LINK
Superior	0700543	28in Urethane Belt Scraper Wiper Blade	link



0700543

BRAND	PART #	DESCRIPTION	LINK
Superior	P3020601	Primary Belt Cleaner Scraper Wiper Assembly for 30 inch Belt Widths	link



P3020601

BRAND	PART #	DESCRIPTION	LINK
Superior	0700544	34in Urethane Belt Scraper Wiper Blade	link



0700544

BRAND	PART #	DESCRIPTION	LINK
Superior	P3620661	Primary Belt Cleaner Scraper Wiper Assembly for 36 inch Belt Widths	link



P3620661

SUPERIOR BATCH PLANT IDLERS

BRAND	PART #	DESCRIPTION	LINK
-------	--------	-------------	------

Superior 0700545 40in Urethane Belt Scraper Wiper Blade [link](#)

0700545



BRAND	PART #	DESCRIPTION	LINK
-------	--------	-------------	------

Superior P4280721 Primary Belt Cleaner Scraper Wiper Assembly for 42 inch Belt Widths [link](#)



BRAND	PART #	DESCRIPTION	LINK
-------	--------	-------------	------

Superior 0700546 46in Urethane Belt Scraper Wiper Blade [link](#)

0700546



BRAND	PART #	DESCRIPTION	LINK
-------	--------	-------------	------

Superior 0700547 46in Urethane Belt Scraper Wiper Blade [link](#)



BRAND	PART #	DESCRIPTION	LINK
-------	--------	-------------	------

Superior P5420842 Primary Belt Cleaner Scraper Wiper Assembly for 54 inch Belt Widths [link](#)

P5420842



BRAND	PART #	DESCRIPTION	LINK
-------	--------	-------------	------

Superior 0700549 58in Urethane Belt Scraper Wiper Blade [link](#)



BRAND	PART #	DESCRIPTION	LINK
-------	--------	-------------	------

Superior P7221022 Primary Belt Cleaner Scraper Wiper Assembly for 72 inch Belt Widths [link](#)

P7221022



BRAND	PART #	DESCRIPTION	LINK
-------	--------	-------------	------

Superior P2480541 Primary Belt Cleaner Scraper Wiper Assembly for 24 inch Belt Widths [link](#)



SUPERIOR BATCH PLANT IDLERS

BRAND	PART #	DESCRIPTION	LINK
-------	--------	-------------	------

Superior P3080601 Primary Belt Cleaner Scraper Wiper Assembly for 30 inch Belt Widths [link](#)



BRAND	PART #	DESCRIPTION	LINK
-------	--------	-------------	------

Superior P3680661 Primary Belt Cleaner Scraper Wiper Assembly for 36 inch Belt Widths [link](#)

P3680661



BRAND	PART #	DESCRIPTION	LINK
-------	--------	-------------	------

Superior P4280721 Primary Belt Cleaner Scraper Wiper Assembly for 42 inch Belt Widths [link](#)



BRAND	PART #	DESCRIPTION	LINK
-------	--------	-------------	------

Superior P6080902 Primary Belt Cleaner Scraper Wiper Assembly for 60 inch Belt Widths [link](#) no pic

BRAND	PART #	DESCRIPTION	LINK
-------	--------	-------------	------

no pic Superior 32000097 Belt Scraper Bracket Tensioner Assembly [link](#)

BRAND	PART #	DESCRIPTION	LINK
-------	--------	-------------	------

Superior 32000188 Primary Exterra Belt Cleaner Field Fit Mounting Bracket [link](#)

32000188



BRAND	PART #	DESCRIPTION	LINK
-------	--------	-------------	------

no pic Superior S300360RT Secondary Belt Wiper Scraper Cleaner for 30in Belt [link](#)

SUPERIOR BATCH PLANT IDLERS

BRAND	PART #	DESCRIPTION	LINK
-------	--------	-------------	------

Superior S360366RT Secondary Belt Wiper Scraper Cleaner for 36in Belt [link](#) no pic



BRAND	PART #	DESCRIPTION	LINK
-------	--------	-------------	------

Superior P36661KIT 36in Cleaner Belt Kit No Blade [link](#)

BRAND	PART #	DESCRIPTION	LINK
-------	--------	-------------	------

Superior SFLDN2368066T Dual Belt Cleaner [link](#) no pic

no pic

BRAND	PART #	DESCRIPTION	LINK
-------	--------	-------------	------

Superior SFLD2362066T Dual Belt Cleaner [link](#)

BRAND	PART #	DESCRIPTION	LINK
-------	--------	-------------	------

Superior 1300975 Wiper Blade Safety Snap Pin [link](#) no pic

no pic

BRAND	PART #	DESCRIPTION	LINK
-------	--------	-------------	------

Superior 1810002 Sonicscout Material Sensor for 24-48 Belt Widths [link](#)

BRAND	PART #	DESCRIPTION	LINK
-------	--------	-------------	------

Superior 44050130 30in Guard Assembly Return Roller [link](#) no pic

no pic

BRAND	PART #	DESCRIPTION	LINK
-------	--------	-------------	------

Superior 44050136 36in Guard Assembly Return Roller [link](#)

STEPHENS BATCH PLANT IDLERS

BRAND	PART #	DESCRIPTION	LINK
-------	--------	-------------	------

Stephens B4R30SB Plant Conveyor Return Idler for 30in Belt [link](#)



0200036

BRAND	PART #	DESCRIPTION	LINK
-------	--------	-------------	------

Stephens 0200036 Plant Roller Drum Bushing [link](#)

BRAND	PART #	DESCRIPTION	LINK
-------	--------	-------------	------

Stephens WXPW1838PXT Heavy Duty Wing Pulley with Bushings [link](#)



CON-E-CO REPLACEMENT BATCH PLANT IDLERS

1237534	BRAND	PART #	DESCRIPTION	LINK
	Con-E-Co Aftermarket	1237534	Conveyor Take Up Assembly	link

BRAND	PART #	DESCRIPTION	LINK
Con-E-Co Aftermarket	SP0081	Take-Up Frame	link no pic

1237540	BRAND	PART #	DESCRIPTION	LINK
	Con-E-Co Aftermarket	1237540	Tru-Trof 30in Return Roller	link

BRAND	PART #	DESCRIPTION	LINK
Con-E-Co Aftermarket	152960	24in x 4in Cema B Return Idler	link 152960



BRAND	PART #	DESCRIPTION	LINK
no pic	Con-E-Co Aftermarket	152961	Return Idler link

BRAND	PART #	DESCRIPTION	LINK
Con-E-Co Aftermarket	152970	30in x 4in Cema B Return Idler	link 152970



152776	BRAND	PART #	DESCRIPTION	LINK
	Con-E-Co Aftermarket	152776	Flat Conveyor Roller Return	link

CON-E-CO REPLACEMENT BATCH PLANT IDLERS

BRAND	PART #	DESCRIPTION	LINK
Con-E-Co Aftermarket	152980	Precision 36in x 4in Cema B Return Idler	link 152980



152787	BRAND	PART #	DESCRIPTION	LINK
	Con-E-Co Aftermarket	152787	Return Idler	link

BRAND	PART #	DESCRIPTION	LINK
Con-E-Co Aftermarket	152990	Return Idler	link 152990



0071962	BRAND	PART #	DESCRIPTION	LINK
	Con-E-Co Aftermarket	0071962	Return Idler for 24in Belt	link

BRAND	PART #	DESCRIPTION	LINK
Con-E-Co Aftermarket	0072962	Return Idler	link 0072962



1374921	BRAND	PART #	DESCRIPTION	LINK
	Con-E-Co Aftermarket	1374921	36in x 4in Cema B Return Idler	link

BRAND	PART #	DESCRIPTION	LINK
Con-E-Co Aftermarket	1237292	3.5in Drop Idler Brackets	link 1237292



CON-E-CO REPLACEMENT BATCH PLANT IDLERS

no pic	BRAND	PART #	DESCRIPTION	LINK
	Con-E-Co Aftermarket	182986	Return Idler for 30in Belts	link

BRAND	PART #	DESCRIPTION	LINK
Con-E-Co Aftermarket	182901	Rubber Disc Return Idler	link

no pic



152820

BRAND	PART #	DESCRIPTION	LINK
Con-E-Co Aftermarket	152820	24in x 20degree x 4in Cema B Troughing Idler	link

BRAND	PART #	DESCRIPTION	LINK
Con-E-Co Aftermarket	1375227	24in Cema B Equal Troughing Idler	link



1375227



152830

BRAND	PART #	DESCRIPTION	LINK
Con-E-Co Aftermarket	152830	30in x 20degree x 4in Cema B Troughing Idler	link

BRAND	PART #	DESCRIPTION	LINK
Con-E-Co Aftermarket	152833	Troughing Idler	link

no pic

no pic

BRAND	PART #	DESCRIPTION	LINK
Con-E-Co Aftermarket	152831	Troughing Idler	link

CON-E-CO REPLACEMENT BATCH PLANT IDLERS

BRAND	PART #	DESCRIPTION	LINK
Con-E-Co Aftermarket	1237279	30in x 35degree x 4in Cema B Troughing Idler	link



1237279

no pic

BRAND	PART #	DESCRIPTION	LINK
Con-E-Co Aftermarket	152809	Cema B 45 Degree Equal Troughing Idler for 30in Belt	link

BRAND	PART #	DESCRIPTION	LINK
Con-E-Co Aftermarket	152839	Equal Impact Troughing Idler	link



152839



1237280

BRAND	PART #	DESCRIPTION	LINK
Con-E-Co Aftermarket	1237280	Troughing Idler	link

BRAND	PART #	DESCRIPTION	LINK
Con-E-Co Aftermarket	152789	Equal Troughing Idler Assembly	link



152789

no pic

BRAND	PART #	DESCRIPTION	LINK
Con-E-Co Aftermarket	1375228	36in x 35degree x 5in Cema C Troughing Idler	link

BRAND	PART #	DESCRIPTION	LINK
Con-E-Co Aftermarket	1473140	24in x 20degree x 4in Cema B Troughing Idler	link



1473140

CON-E-CO REPLACEMENT BATCH PLANT IDLERS

no pic	BRAND	PART #	DESCRIPTION	LINK
	Con-E-Co Aftermarket	1466606	24in x 35degree x 4in Cema B Self-Aligning Idler	link

BRAND	PART #	DESCRIPTION	LINK
Con-E-Co Aftermarket	1481179	30in x 20degree x 4in Cema B Troughing Idler	link



BRAND	PART #	DESCRIPTION	LINK
Con-E-Co Aftermarket	0072967	24in x 35degree x 4in Cema B Self-Aligning Idler	link

BRAND	PART #	DESCRIPTION	LINK
Con-E-Co Aftermarket	1457626	36in x 20degree x 4in Cema B Troughing Idler	link



BRAND	PART #	DESCRIPTION	LINK
Con-E-Co Aftermarket	1481180	36in x 35degree x 4in Cema B Troughing Idler	link



BRAND	PART #	DESCRIPTION	LINK
Con-E-Co Aftermarket	1421766	42in x 20degree x 4in Cema B Troughing Idler	link

BRAND	PART #	DESCRIPTION	LINK
Con-E-Co Aftermarket	1421764	Equal Troughing Idler	link

no pic

CON-E-CO REPLACEMENT BATCH PLANT IDLERS

BRAND	PART #	DESCRIPTION	LINK
Con-E-Co Aftermarket	1181510	Troughing Idler	link



BRAND	PART #	DESCRIPTION	LINK
Con-E-Co Aftermarket	1481182	Troughing Idler	link

BRAND	PART #	DESCRIPTION	LINK
Con-E-Co Aftermarket	1421990	Tension Wiper Assembly	link

no pic



BRAND	PART #	DESCRIPTION	LINK
Con-E-Co Aftermarket	1222742	22in Long Urethane Belt Cleaner Blade Wiper for 24in Belt	link

BRAND	PART #	DESCRIPTION	LINK
Con-E-Co Aftermarket	1228743	28in Long Urethane Belt Cleaner Blade Wiper for 30in Belt	link



BRAND	PART #	DESCRIPTION	LINK
Con-E-Co Aftermarket	1228744	34in Long Urethane Belt Cleaner Blade Wiper for 36in Belt	link

BRAND	PART #	DESCRIPTION	LINK
Con-E-Co Aftermarket	143255	Urethane Belt Cleaner Replacement Blade Wiper	link



CON-E-CO REPLACEMENT BATCH PLANT IDLERS

1423431		BRAND	PART #	DESCRIPTION	LINK
		Con-E-Co Aftermarket	1423431	46in Long Urethane Belt Cleaner Blade Wiper for 48in Belt	link

BRAND	PART #	DESCRIPTION	LINK
Con-E-Co Aftermarket	1408480	Primary Urethane Belt Scraper Wiper Blade 52 inch	link



0116923		BRAND	PART #	DESCRIPTION	LINK
		Con-E-Co Aftermarket	0116923	30in Belt Wiper	link

ERIE STRAYER BATCH PLANT IDLERS

27158		BRAND	PART #	DESCRIPTION	LINK
		Erie Strayer	27158	35 Degree Troughing Idler	link

BRAND	PART #	DESCRIPTION	LINK
Erie Strayer	27160	Plant Conveyor 45 Degree Troughing Idler	link

no pic

BRAND	PART #	DESCRIPTION	LINK
Erie Strayer	59897	Plant Conveyor Troughing Idler	link

no pic

JOHNSON ROSS BATCH PLANT IDLERS

5578358



BRAND	PART #	DESCRIPTION	LINK
Johnson Ross	5578358	Return Idler 24.5in Roller with 4in Cans	link

BRAND	PART #	DESCRIPTION	LINK
Johnson Ross	5578359	Return Idler 26.75in Roller with 4in Cans	link

5578359



5578359



BRAND	PART #	DESCRIPTION	LINK
Johnson Ross	5578360	Return Idler 30.5in Roller with 4in Cans	link

BRAND	PART #	DESCRIPTION	LINK
Johnson Ross	5578362	Return Idler	link

5578359



5578424



BRAND	PART #	DESCRIPTION	LINK
Johnson Ross	5578424	Impact Roller with 5in Rubber	link

Johnson Ross	5578425	Impact Roller with 5in Rubber	link
--------------	---------	-------------------------------	----------------------

JOHNSON ROSS BATCH PLANT IDLERS

BRAND	PART #	DESCRIPTION	LINK
Johnson Ross	5576927	Standard Roll Bearing	link

no pic

no pic

BRAND	PART #	DESCRIPTION	LINK
Johnson Ross	5576862	Double-Ended Shaft	link

BRAND	PART #	DESCRIPTION	LINK
Johnson Ross	004002339003	Single-Ended Shaft	link

no pic

LIDDELL BATCH PLANT IDLERS

401365001	BRAND	PART #	DESCRIPTION	LINK
	Liddell	401365001	Idler CEMA B Inline-PPI	link

BRAND	PART #	DESCRIPTION	LINK
Liddell	401365002	Idler CEMA B Sealed-PPI	link

no pic

BRAND	PART #	DESCRIPTION	LINK
Liddell	401366003	24in Class B Return Roller	link

no pic

BRAND	PART #	DESCRIPTION	LINK
Liddell	401366001	Return Idler	link

no pic

BRAND	PART #	DESCRIPTION	LINK
Liddell	401366011	Return Idler for 30in Belt	link

no pic

BRAND	PART #	DESCRIPTION	LINK
Liddell	401367003	Adamson Rubber Disc Return Impact Idler Sealed	link

no pic

BRAND	PART #	DESCRIPTION	LINK
Liddell	401367001	Idler Rubber Disc Return	link

no pic

MCNEILUS BATCH PLANT IDLERS

BRAND	PART #	DESCRIPTION	LINK
McNeilus	74071962	24in x 4in Cema B Return Idler	link

74071962



74072962



BRAND	PART #	DESCRIPTION	LINK
McNeilus	74072962	30in x 4in Cema B Return Idler	link

BRAND	PART #	DESCRIPTION	LINK
McNeilus	74073003	36in x 4in Cema B Return Idler	link

74073003



74073009



BRAND	PART #	DESCRIPTION	LINK
McNeilus	74073009	Return Idler	link

BRAND	PART #	DESCRIPTION	LINK
McNeilus	74071966	24in x 20degree x 4in Cema B Troughing Idler	link

74071966



74071967



BRAND	PART #	DESCRIPTION	LINK
McNeilus	74071967	24in x 35degree x 4in Cema B Troughing Idler	link

74072966



BRAND	PART #	DESCRIPTION	LINK
McNeilus	74072966	30in x 20degree x 4in Cema B Troughing Idler	link

BRAND	PART #	DESCRIPTION	LINK
McNeilus	74072967	30in x 35degree x 4in Cema B Troughing Idler	link



74073001



BRAND	PART #	DESCRIPTION	LINK
McNeilus	74073001	36in x 20degree x 4in Cema B Troughing Idler	link

BRAND	PART #	DESCRIPTION	LINK
McNeilus	74073002	36in x 35degree x 4in Cema B Troughing Idler	link



PAGE
INTENTIONALLY
LEFT BLANK

PRECISION HEAD PULLEYS

no pic

BRAND	PART #	DESCRIPTION	LINK
Precision	PXT25	Crowned Face Head Pulley	link

SUPERIOR HEAD PULLEYS

DCEMA1432CFXT30



BRAND	PART #	DESCRIPTION	LINK
Superior	DCEMA1432CFXT30	14in Diameter Drum Head Pulley	link

DCEMA1232CFXT30



BRAND	PART #	DESCRIPTION	LINK
Superior	DCEMA1232CFXT30	Smooth Drum Head Pulley	link

BRAND	PART #	DESCRIPTION	LINK
Superior	DCEMA1432CFXT3538H	14in Diameter X 32in Long Fully Lagged Drum Head Pulley	link

STEPHENS HEAD PULLEYS

no pic

BRAND	PART #	DESCRIPTION	LINK
Stephens	HXPU1232PXT30	Head Pulley	link

LIDDELL HEAD PULLEYS

BRAND	PART #	DESCRIPTION	LINK
Liddell	LID16X32PUL	Head Pulley - 16x32 Lagged	link

no pic

no pic

BRAND	PART #	DESCRIPTION	LINK
Liddell	CRAFTLAG50016	Head Pulley with Replaceable Lag	link

BRAND	PART #	DESCRIPTION	LINK
Liddell	900100022	Pro-Duty Head Pulley Drum	link

no pic

no pic

BRAND	PART #	DESCRIPTION	LINK
Liddell	900100023	Head Pulley Shaft	link

BRAND	PART #	DESCRIPTION	LINK
Liddell	900100024	Crowned Face Head Pulley	link

no pic

D12X26CFPXT25

BRAND	PART #	DESCRIPTION	LINK
Liddell	D12X26CFPXT25	Pro Duty Drum Head Pulley	link

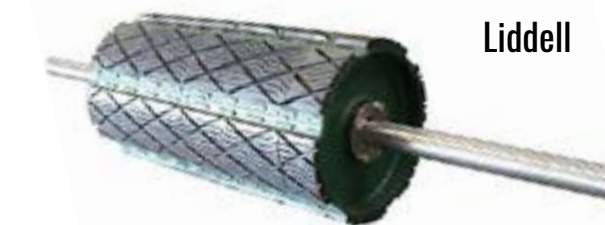

PXT30PRODUTY16X32

BRAND	PART #	DESCRIPTION	LINK
Liddell	PXT30PRODUTY16X32	No Lagging Head Drum Pulley	link



STEPHENS LOAD CELLS

202103KB



BRAND	PART #	DESCRIPTION	LINK
Stephens	202103KB	S-Beam Load Cell With 150ft Cable	link

202105K



BRAND	PART #	DESCRIPTION	LINK
Stephens	202105K	Load Cell S-Beam	link

CON-E-CO AFTERMARKET LOAD CELLS

BRAND	PART #	DESCRIPTION	LINK
Con-E-Co Aftermarket	154375	Load Cell Isolator	link

no pic

no pic

BRAND	PART #	DESCRIPTION	LINK
Con-E-Co Aftermarket	154366	Load Cell Threaded Stud	link

BRAND	PART #	DESCRIPTION	LINK
Con-E-Co Aftermarket	154393	5K Load Cell	link



154393



1245151

BRAND	PART #	DESCRIPTION	LINK
Con-E-Co Aftermarket	1245151	Fastener 3/4in-16 Grade 8 Zinc Plated Hex Nut	link

BRAND	PART #	DESCRIPTION	LINK
Con-E-Co Aftermarket	1101235	Fastener 3/4in-16 X 5 5/16in Full Stud	link

no pic

no pic

BRAND	PART #	DESCRIPTION	LINK
Con-E-Co Aftermarket	1468197	20K Load Cell S-Beam	link

0115088

BRAND	PART #	DESCRIPTION	LINK
Con-E-Co Aftermarket	0115088	Plant Aggregate Gate Nylatron Bushing	link



MCNEILUS LOAD CELLS

111007



BRAND	PART #	DESCRIPTION	LINK
McNeilus	111007	5K Load Cell	link

111006

BRAND	PART #	DESCRIPTION	LINK
McNeilus	111006	20K Load Cell	link



RICE LAKE LOAD CELLS

BRAND	PART #	DESCRIPTION	LINK	
Rice Lake	30339	3K Load Cell	link	no pic

no pic

BRAND	PART #	DESCRIPTION	LINK
Rice Lake	17814	Load Cell Mounting Kit	link

BRAND	PART #	DESCRIPTION	LINK	
Rice Lake	17816	Load Cell Mounting Kit	link	no pic

21436



BRAND	PART #	DESCRIPTION	LINK
Rice Lake	21436	500 lb S-Beam Load Cell	link

BRAND	PART #	DESCRIPTION	LINK	
Rice Lake	21438	1K S-Beam	link	no pic

21439



BRAND	PART #	DESCRIPTION	LINK
Rice Lake	21439	1.5K Load Cell	link

BRAND	PART #	DESCRIPTION	LINK
Rice Lake	21440	2K S-Beam	link

21440



21441



BRAND	PART #	DESCRIPTION	LINK
Rice Lake	21441	2.5K S-Beam	link

RICE LAKE LOAD CELLS



21442

BRAND	PART #	DESCRIPTION	LINK
Rice Lake	21442	3K S-Beam Load Cell	link



21443

BRAND	PART #	DESCRIPTION	LINK
Rice Lake	21443	5K S-Beam	link

BRAND	PART #	DESCRIPTION	LINK
Rice Lake	21444	10K Load Cell	link

no pic

BRAND	PART #	DESCRIPTION	LINK
Rice Lake	21445	15K S-Beam	link

no pic



21446

BRAND	PART #	DESCRIPTION	LINK
Rice Lake	21446	20K S-Beam	link

BRAND	PART #	DESCRIPTION	LINK
Rice Lake	21410	5K S-Beam	link

no pic



21411

BRAND	PART #	DESCRIPTION	LINK
Rice Lake	21411	10K S-Beam	link

RICE LAKE LOAD CELLS

BRAND	PART #	DESCRIPTION	LINK
Rice Lake	21413	20K S-Beam	link

no pic



36263

BRAND	PART #	DESCRIPTION	LINK
Rice Lake	36263	5K Load Cell DEB	link

67881

BRAND	PART #	DESCRIPTION	LINK
Rice Lake	67881	5K S-Beam Load Cell	link



98875

BRAND	PART #	DESCRIPTION	LINK
Rice Lake	98875	2.5K S-Beam Stainless Steel Load Cell	link

BRAND	PART #	DESCRIPTION	LINK
Rice Lake	17448	250lb SPT Load Cell	link

no pic



17726

BRAND	PART #	DESCRIPTION	LINK
Rice Lake	17726	Load Cell Isolator 1/2-20 x 1/2-20 600 lb	link

BRAND	PART #	DESCRIPTION	LINK
Rice Lake	17728	Load Cell Isolator 1/2-13 NC X 1/2-20 NF 600 lb	link

no pic

RICE LAKE LOAD CELLS

no pic

BRAND	PART #	DESCRIPTION	LINK
Rice Lake	33572	Load Cell Threaded Stud 1/2-20 X 7/2-13 3000lb	link

BRAND	PART #	DESCRIPTION	LINK
Rice Lake	33573	Load Cell Threaded Stud 1/2-20 3000lb SST with Jam Nuts	link

no pic



88956

BRAND	PART #	DESCRIPTION	LINK
Rice Lake	88956	Four Channel JB4SS Junction Box	link

BRAND	PART #	DESCRIPTION	LINK
Rice Lake	131923	Digital Weight Indicator	link

no pic

no pic

BRAND	PART #	DESCRIPTION	LINK
Rice Lake	126564	Digital Weight Indicator	link

BRAND	PART #	DESCRIPTION	LINK
Rice Lake	129662	Transceiver Pair	link

no pic

no pic

BRAND	PART #	DESCRIPTION	LINK
Rice Lake	167091	4in Painted Steel LED Laser Light 2 Display	link

BRAND	PART #	DESCRIPTION	LINK
Rice Lake	167092	6in Painted Steel LED Laser Light 2 Display	link

no pic

ARTECH LOAD CELLS

2021015K150

BRAND	PART #	DESCRIPTION	LINK
Artech	2021015K150	1.5K S-Beam Load Cell With 150ft Cable	link



202103K150

BRAND	PART #	DESCRIPTION	LINK
Artech	202103K150	3K S-Beam Load Cell With 150ft Cable	link



BRAND	PART #	DESCRIPTION	LINK
Artech	2021020K	20K S-Beam Load Cell with 30ft Cable	link

no pic

9363B101K20T1

BRAND	PART #	DESCRIPTION	LINK
Revere	9363B101K20T1	S-Beam Stainless Steel Load Cell	link



9363B1025K20T1

BRAND	PART #	DESCRIPTION	LINK
Revere	9363B1025K20T1	S-Beam Stainless Steel Load Cell	link

BRAND	PART #	DESCRIPTION	LINK
Revere	462D325010P1	250lb SPT Load Cell	link

no pic

PAGE
INTENTIONALLY
LEFT BLANK

MOTORS & REDUCERS

no pic	BRAND	PART #	DESCRIPTION	LINK
	Stephens	MOT11846056CWPB	Radial Stacker Tracking Motor	link

BRAND	PART #	DESCRIPTION	LINK	no pic
Stephens	MOT121811556C	1/2 HP Turnhead Motor	link	

no pic	BRAND	PART #	DESCRIPTION	LINK
	Stephens	MOT518460184T	5HP 1800 RPM 460V 3 Phase Motor	link

BRAND	PART #	DESCRIPTION	LINK	no pic
Stephens	MOT751800460213T	7.5HP 3 Phase 1800RPM Conveyor Motor	link	

ARB2014L2



BRAND	PART #	DESCRIPTION	LINK
Stephens	ARB2014L2	Shaker Motor	link

BRAND	PART #	DESCRIPTION	LINK
Stephens	254208	Auger Gearbox Assembly	link



no pic	BRAND	PART #	DESCRIPTION	LINK
	Stephens	245551	Gear Box	link

BRAND	PART #	DESCRIPTION	LINK
Stephens	253159	Auger Reducer Assembly	link



MOTORS & REDUCERS

BRAND	PART #	DESCRIPTION	LINK	no pic
Stephens	902002	15:1 Ratio Shaft Mount Speed Reducer	link	

no pic	BRAND	PART #	DESCRIPTION	LINK
	Stephens	902022	Dodge Speed Reducer	link

BRAND	PART #	DESCRIPTION	LINK	no pic
Stephens	902109	Dodge Speed Reducer Torque Arm Kit	link	

no pic	BRAND	PART #	DESCRIPTION	LINK
	Con-E-Co Aftermarket	1237310	Speed Reducer	link

BRAND	PART #	DESCRIPTION	LINK
Con-E-Co Aftermarket	153780	Reducer Screw Mount	link



no pic	BRAND	PART #	DESCRIPTION	LINK
	Con-E-Co Aftermarket	153910	Gear Box	link

BRAND	PART #	DESCRIPTION	LINK	no pic
Con-E-Co Aftermarket	153840	Speed Reducer	link	

no pic	BRAND	PART #	DESCRIPTION	LINK
	Con-E-Co Aftermarket	153815	15:1 Ratio Shaft Mount Speed Reducer	link

MOTORS & REDUCERS

no pic	BRAND	PART #	DESCRIPTION	LINK
	Con-E-Co Aftermarket	153817	Tall Torque Arm Reducer	link

BRAND	PART #	DESCRIPTION	LINK	no pic
Con-E-Co Aftermarket	153800	Adapter C4 Reducer	link	

no pic	BRAND	PART #	DESCRIPTION	LINK
	Con-E-Co Aftermarket	1375241	1-15/16in Bushing Reducer	link

BRAND	PART #	DESCRIPTION	LINK	no pic
Con-E-Co Aftermarket	153790	Reducer Shaft Drive	link	



BRAND	PART #	DESCRIPTION	LINK
Erie Strayer	58933	Rockford Spindle Adapter	link

BRAND	PART #	DESCRIPTION	LINK	no pic
Erie Strayer	67451	Planetary Drive Reducer	link	

no pic	BRAND	PART #	DESCRIPTION	LINK
	Liddell	900025001	Gear Reducer	link

BRAND	PART #	DESCRIPTION	LINK
Liddell	900210003	Auger Gearbox Assembly	link



MOTORS & REDUCERS

BRAND	PART #	DESCRIPTION	LINK	no pic
Liddell	TXT515	Gear Box BT/CT	link	

no pic	BRAND	PART #	DESCRIPTION	LINK
	Liddell	900264003	Cement Auger Speed Reducer	link

BRAND	PART #	DESCRIPTION	LINK	no pic
Liddell	TA5M	Motor Mount	link	

no pic	BRAND	PART #	DESCRIPTION	LINK
	Liddell	3A64B68QSDX158	Motor Sheave	link

BRAND	PART #	DESCRIPTION	LINK	no pic
Liddell	900024141	7.5HP 3 Phase 1800RPM Conveyor Motor	link	

no pic	BRAND	PART #	DESCRIPTION	LINK
	Liddell	900025272	Reducer Seal Kit	link

BRAND	PART #	DESCRIPTION	LINK	no pic
McNeilus	300115047	Gear Box	link	

254208	BRAND	PART #	DESCRIPTION	LINK
	Dodge	254208	Auger Reducer Assembly	link

BRAND	PART #	DESCRIPTION	LINK
Dodge	TA1107H15	15:1 Turn Down Gear Reducer	link



MOTORS & REDUCERS

no pic	BRAND	PART #	DESCRIPTION	LINK
	Dodge	247160	Conveyor Reducer Assembly - Taper Bushed Gear Reducer	link

BRAND	PART #	DESCRIPTION	LINK	no pic
Dodge	LD2455782	Gear Reducer	link	

no pic	BRAND	PART #	DESCRIPTION	LINK
	Dodge	245112	Gear Reducer Bushing	link

BRAND	PART #	DESCRIPTION	LINK	SCXT305A 
Dodge	SCXT305A	Auger Reducer Assembly	link	

no pic	BRAND	PART #	DESCRIPTION	LINK
	Dodge	HXT505AT6B	Radial Stacker Reducer Assembly	link

BRAND	PART #	DESCRIPTION	LINK	no pic
Dodge	244527	Reducer Assembly	link	

no pic	BRAND	PART #	DESCRIPTION	LINK
	Dodge	TXT505A	Reducer BT/CT	link

BRAND	PART #	DESCRIPTION	LINK	244526 
Dodge	244526	Torque Arm Drive Shaft Mount Speed Reducer	link	

no pic	BRAND	PART #	DESCRIPTION	LINK
	Dodge	247287	Straight Bore Speed Reducer	link

MOTORS & REDUCERS

BRAND	PART #	DESCRIPTION	LINK	no pic
Dodge	248279	Torque Arm Speed Reducer	link	

no pic	BRAND	PART #	DESCRIPTION	LINK
	Dodge	245551	Taper Bushing Reducer	link

BRAND	PART #	DESCRIPTION	LINK	TA1107TB 
Dodge	TA1107TB	1.4375" Reducer Bushing	link	

BRAND	PART #	DESCRIPTION	LINK	TA1107BS 
Dodge	TA1107BS	Speed Reducer Back Stop	link	

BRAND	PART #	DESCRIPTION	LINK	no pic
Dodge	01071311	Reducer Seal Kit	link	

no pic	BRAND	PART #	DESCRIPTION	LINK
	Dodge	01297124	Reducer Retainer Ring	link

BRAND	PART #	DESCRIPTION	LINK	no pic
Dodge	TA2115H15	15:1 Ratio Shaft Mount Speed Reducer	link	

no pic	BRAND	PART #	DESCRIPTION	LINK
	Superior	0500013	Conveyor Reducer Assembly	link

0503689



BRAND	PART #	DESCRIPTION	LINK
Superior	0503689	Auger Gearbox Assembly	link

0500598



BRAND	PART #	DESCRIPTION	LINK
Superior	0500598	Turn Down Gear Reducer	link

050007



BRAND	PART #	DESCRIPTION	LINK
Superior	050007	Speed Reducer	link

0500531



BRAND	PART #	DESCRIPTION	LINK
Superior	0500531	Reducer Bushing	link

0500617



BRAND	PART #	DESCRIPTION	LINK
Superior	0500617	Speed Reducer Back Stop	link

PAGE
INTENTIONALLY
LEFT BLANK

REMOTES



T6004STP

BRAND	PART #	DESCRIPTION	LINK
Tele-Radio	T6004STP	Radial Stacker 4-Function Remote Transmitter with Receiver	link

T60RX04DSL



BRAND	PART #	DESCRIPTION	LINK
Tele-Radio	T60RX04DSL	Standard Receiver 4 Function	link



10000000493

BRAND	PART #	DESCRIPTION	LINK
Tele-Radio	10000000493	Antenna (14 in) for Concrete Plant 6 Function Control	link

PNSR1522T1922



BRAND	PART #	DESCRIPTION	LINK
Tele-Radio	PNSR1522T1922	Remote & Transmitter	link



STLCASE1

BRAND	PART #	DESCRIPTION	LINK
Tele-Radio	STLCASE1	Midi T Transmitter Case with D Ring and Cut Out for Clip	link

T60TX04STLUS



BRAND	PART #	DESCRIPTION	LINK
Tele-Radio	T60TX04STLUS	Concrete Plant 4 Function Midi T Transmitter	link

REMOTES

10000144419



BRAND	PART #	DESCRIPTION	LINK
Tele-Radio	10000144419	Standard Receiver 5 Function	link

T60TX06STLUS



BRAND	PART #	DESCRIPTION	LINK
Tele-Radio	T60TX06STLUS	6 Function Midi T Transmitter	link

T60TX08STLUS



BRAND	PART #	DESCRIPTION	LINK
Tele-Radio	T60TX08STLUS	Midi T-Transmitter, 8 Function, US Type	link

NO PIC

BRAND	PART #	DESCRIPTION	LINK
Tele-Radio	D000122	Voltage Expansion Board	link

190700



BRAND	PART #	DESCRIPTION	LINK
Con-E-Co Aftermarket	190700	Agg Bin 4 Position Turnhead Remote Transmitter and Receiver Assembly	link

NO PIC

BRAND	PART #	DESCRIPTION	LINK
Con-E-Co Aftermarket	700DK1	Agg Bin 8 Position Turnhead Remote Control and Transmitter	link

NO PIC

BRAND	PART #	DESCRIPTION	LINK
Liddell	900188103	Transmitter with 2 Remotes	link

BRAND	PART #	DESCRIPTION	LINK
-------	--------	-------------	------

Liddell	900188004	Remote Protective Inlay Cover	link	NO PIC
---------	-----------	-------------------------------	----------------------	--------

NO PIC

BRAND	PART #	DESCRIPTION	LINK
Liddell	900188007	Rubber Protective Boot for TM6000 Remote	link

BRAND	PART #	DESCRIPTION	LINK
-------	--------	-------------	------

Liddell	900188005	Transmitter Protective Boot	link	NO PIC
---------	-----------	-----------------------------	----------------------	--------

**PAGE
INTENTIONALLY
LEFT BLANK**

OVERFILL PROTECTION

NO PIC

BRAND	PART #	DESCRIPTION	LINK
Stephens	ELB100WSI	Electric Silo Overfill Warning	link

BRAND	PART #	DESCRIPTION	LINK
Stephens	8314H7	Silo Anti-Overfill Protection Valve	link



6768843I



BRAND	PART #	DESCRIPTION	LINK
Stephens	6768843I	3 Silo Overfill Protection Panel Assembly - Anti-Overfill Horn and Light	link

BRAND	PART #	DESCRIPTION	LINK
C&W DustTech	SS130	Overfill Control Panel and High Level Alarm	link



BRAND	PART #	DESCRIPTION	LINK
C&W DustTech	SS134	Anti Overfill System for 4in Pipe	link

BRAND	PART #	DESCRIPTION	LINK
C&W DustTech	CT006	Overfill Control Panel and High/Low Level Alarm	link



OVERFILL PROTECTION

ET000



BRAND	PART #	DESCRIPTION	LINK
C&W DustTech	ET000	Timer Relay for AntiOverfill System Control Panel	link

AL010



BRAND	PART #	DESCRIPTION	LINK
C&W DustTech	AL010	Silo Anti-Overfill Protection Air Regulator Preset at 55 PSI	link

S0045



BRAND	PART #	DESCRIPTION	LINK
C&W DustTech	S0045	1/4in Solenoid Valve	link

NO PIC

BRAND	PART #	DESCRIPTION	LINK
Con-E-Co Aftermarket	114200	Warning Alarm Horn	link

R1000032

BRAND	PART #	DESCRIPTION	LINK
Liddell	R1000032	4in Overfill System	link



OVERFILL PROTECTION



R1000029

BRAND	PART #	DESCRIPTION	LINK
Liddell	R1000029	Anti Overfill System for 4 inch Pipe	link

BRAND	PART #	DESCRIPTION	LINK
Liddell	R07000068	Overfill Control Panel and High/Low Level Alarm	link



R07000068



900093001

BRAND	PART #	DESCRIPTION	LINK
Liddell	900093001	Antioverfill Air Regulator - 55PSI	link

BRAND	PART #	DESCRIPTION	LINK
Liddell	R10000030	Silo Antioverfill System 5 inch	link

NO PIC



1103658

BRAND	PART #	DESCRIPTION	LINK
McNeilus	1103658	Silo Antioverfill Warning Horn	link

BRAND	PART #	DESCRIPTION	LINK
WAM	KCSPF12	Silo Anti-Overfill Safety System Pressure Gauge	link

KCSPF12



OVERFILL PROTECTION

BRAND	PART #	DESCRIPTION	LINK
WAM	KCSLS2	Silo Anti-Overfill Safety System Audible Alarm - 110V	link

KCSLS2

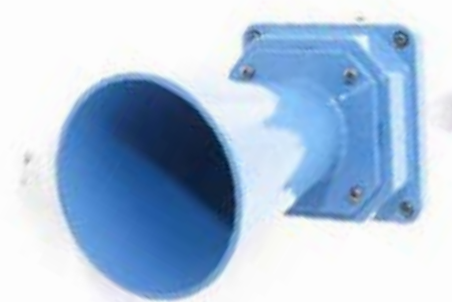

KCSSP1

BRAND	PART #	DESCRIPTION	LINK
WAM	KCSSP1	Silo Anti-Overfill Safety System Individual Power Panel	link

BRAND	PART #	DESCRIPTION	LINK
WAM	KCSSC1	Silo Anti-Overfill Safety System Central Control Board	link

KCSSC1



KCS1PM4001



BRAND	PART #	DESCRIPTION	LINK
WAM	KCS1PM4001	Silo Anti-Overfill Safety System Differential Pressure Switch	link

BRAND	PART #	DESCRIPTION	LINK
WAM	KCSVMX01	Silo Anti-Overfill Safety System Pinch Valve Control Panel	link

KCSVMX01



NO PIC	BRAND	PART #	DESCRIPTION	LINK
	WAM	KCSSCTOUCH	Silo Anti-Overfill Safety System Central Control Board	link

BRAND	PART #	DESCRIPTION	LINK
WAM	KCSIPE1	Silo Anti-Overfill Safety System Pressure Gauge - Electronic	link

NO PIC

NO PIC	BRAND	PART #	DESCRIPTION	LINK
	WAM	KCSIPX	Silo Anti-Overfill Safety System Differential Pressure Switch Mounting Flange for KCS1PM4001	link

BRAND	PART #	DESCRIPTION	LINK
WAM	BOB11050	Solenoid Coil For V5V81 and V5V41 - 110VAC 8W	link

BOB11050



NO PIC	BRAND	PART #	DESCRIPTION	LINK
	WAM	BOB024VDC15W	Solenoid Coil 24VDC 15W	link

PAGE
INTENTIONALLY
LEFT BLANK

SOLENOID VALVES

6313D000PM112DA



BRAND	PART #	DESCRIPTION	LINK
Stephens	6313D000PM112DA	Single Solenoid Mac Valve	link

6333D611PM112DA



BRAND	PART #	DESCRIPTION	LINK
Stephens	6333D611PM112DA	Single Solenoid Mac Double Solenoid Valve with Base	link

6333D000PM112DA



BRAND	PART #	DESCRIPTION	LINK
Stephens	6333D000PM112DA	Double Solenoid Valve Without Base	link

55B12PI112CA



BRAND	PART #	DESCRIPTION	LINK
Stephens	55B12PI112CA	Aeration Valve Assembly	link

912BPM112CA



BRAND	PART #	DESCRIPTION	LINK
Stephens	912BPM112CA	Air Valve-Single Solenoid - 120VAC	link

L6653921153



BRAND	PART #	DESCRIPTION	LINK
Stephens	L6653921153	Double Solenoid Valve	link

SOLENOID VALVES

BRAND	PART #	DESCRIPTION	LINK
Stephens	K63008	Repair Kit	link

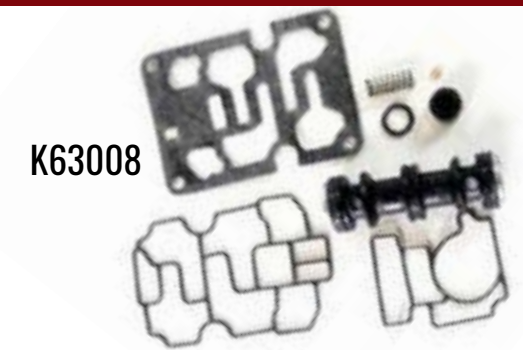

K63016

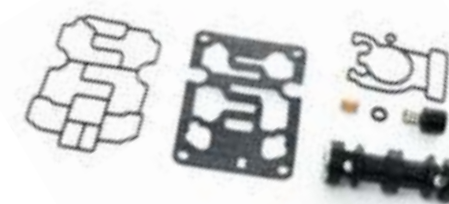

BRAND	PART #	DESCRIPTION	LINK
Stephens	K63016	Air Valve Repair Kit for Mac 6311D & 6313D Single Solenoid Kit	link

K63019



BRAND	PART #	DESCRIPTION	LINK
Stephens	K63019	Double Solenoid Repair Kit Mac New Style	link

K352151



BRAND	PART #	DESCRIPTION	LINK
Stephens	K352151	Double Air Valve Repair Kit	link

1108388



BRAND	PART #	DESCRIPTION	LINK
Con-E-Co Aftermarket	1108388	Single Solenoid Electric Over Air Valve	link

1108385



BRAND	PART #	DESCRIPTION	LINK
Con-E-Co Aftermarket	1108385	Single Solenoid Electric Over Air Valve Seal Kit with Spool for 1108388	link

SOLENOID VALVES

1261074		BRAND	PART #	DESCRIPTION	LINK
		Con-E-Co Aftermarket	1261074	Pilot Valve - 120V Solenoid Coil	link

BRAND	PART #	DESCRIPTION	LINK
Con-E-Co Aftermarket	1108380	Single Solenoid Electric Over Air Valve with Stand Alone Base	link



1108378		BRAND	PART #	DESCRIPTION	LINK
		Con-E-Co Aftermarket	1108378	Single Solenoid Electric Valve	link

BRAND	PART #	DESCRIPTION	LINK
Con-E-Co Aftermarket	1108389	Mac Double Solenoid Electric Over Air Valve	link



1108386		BRAND	PART #	DESCRIPTION	LINK
		Con-E-Co Aftermarket	1108386	Double Electric Over Air Valve Seal Kit with Spool for 1108389	link

BRAND	PART #	DESCRIPTION	LINK
Con-E-Co Aftermarket	1108387	Solenoid Pilot Valve	link



SOLENOID VALVES

BRAND	PART #	DESCRIPTION	LINK	
Con-E-Co Aftermarket	1108381	Double Solenoid Electric Over Air Inching Valve	link	1108381

1108379		BRAND	PART #	DESCRIPTION	LINK
		Con-E-Co Aftermarket	1108379	Double Solenoid Air Valve	link

BRAND	PART #	DESCRIPTION	LINK	
Con-E-Co Aftermarket	0072557	Single Solenoid Mac Valve	link	0072557

0072558		BRAND	PART #	DESCRIPTION	LINK
		Con-E-Co Aftermarket	0072558	Seal Kit for Single Solenoid Valves	link

BRAND	PART #	DESCRIPTION	LINK	
Con-E-Co Aftermarket	0072553	Pilot and Solenoid for 6000 Series Valves	link	0072553

0072525		BRAND	PART #	DESCRIPTION	LINK
		Con-E-Co Aftermarket	0072525	Concrete Plant Single Solenoid MAC Valve with Base	link

BRAND	PART #	DESCRIPTION	LINK	
Con-E-Co Aftermarket	1168349	Plant Mac Valve with 1/2in Individual Stand Alone Base	link	1168349

SOLENOID VALVES



BRAND	PART #	DESCRIPTION	LINK
Con-E-Co Aftermarket	0072552	Double Solenoid Valve Without Base	link

BRAND	PART #	DESCRIPTION	LINK
Con-E-Co Aftermarket	0072554	Seal Kit for Double Mac Valve	link

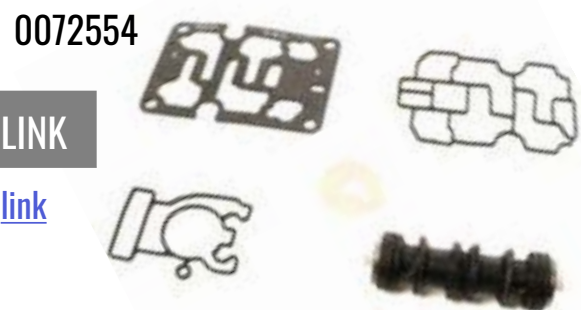

BRAND	PART #	DESCRIPTION	LINK
Con-E-Co Aftermarket	0072526	Double Solenoid Valve with Base	link

BRAND	PART #	DESCRIPTION	LINK
Con-E-Co Aftermarket	1168346	Double Solenoid Electric Over Air Inching Valve with Base	link

no pic



BRAND	PART #	DESCRIPTION	LINK
Con-E-Co Aftermarket	145510	Over Air Valve	link



BRAND	PART #	DESCRIPTION	LINK
Con-E-Co Aftermarket	145600	.38in Solenoid Valve Repair Kit	link

SOLENOID VALVES

BRAND	PART #	DESCRIPTION	LINK
Con-E-Co Aftermarket	145500	Electric Over Air Valve .5in Single Solenoid - 120V	link



BRAND	PART #	DESCRIPTION	LINK
Con-E-Co Aftermarket	145610	.5in Solenoid Valve Repair Kit	link

BRAND	PART #	DESCRIPTION	LINK
Con-E-Co Aftermarket	145520	AAA Electric Over Air Valve - Double Solenoid 3/8	link



BRAND	PART #	DESCRIPTION	LINK
Con-E-Co Aftermarket	145530	AAA Electric Over Air Valve - Double Solenoid 1/2	link

BRAND	PART #	DESCRIPTION	LINK
Con-E-Co Aftermarket	1237174	Classic Solenoid 120 Volt With Dust E	link



BRAND	PART #	DESCRIPTION	LINK
Con-E-Co Aftermarket	145512	Over Air Inching Valve	link

SOLENOID VALVES



145905

BRAND	PART #	DESCRIPTION	LINK
-------	--------	-------------	------

Con-E-Co Aftermarket	145905	Plant Skinner Valve	link
----------------------	--------	---------------------	----------------------

BRAND	PART #	DESCRIPTION	LINK
-------	--------	-------------	------

Con-E-Co Aftermarket	145907	240V Coil	link
----------------------	--------	-----------	----------------------

no pic



1375105

BRAND	PART #	DESCRIPTION	LINK
-------	--------	-------------	------

Con-E-Co Aftermarket	1375105	Single Solenoid	link
----------------------	---------	-----------------	----------------------



57633

BRAND	PART #	DESCRIPTION	LINK
-------	--------	-------------	------

Erie Strayer	57633	Single Solonoid Valve	link
--------------	-------	-----------------------	----------------------



57633ALT

BRAND	PART #	DESCRIPTION	LINK
-------	--------	-------------	------

Erie Strayer	57633ALT	Single Solenoid Electric Over Air Valve	link
--------------	----------	---	----------------------



57635

BRAND	PART #	DESCRIPTION	LINK
-------	--------	-------------	------

Erie Strayer	57635	Bellows Repair Kit	link
--------------	-------	--------------------	----------------------

SOLENOID VALVES

BRAND	PART #	DESCRIPTION	LINK
-------	--------	-------------	------

Erie Strayer	57634	Double Solenoid Valve	link
--------------	-------	-----------------------	----------------------



57634



57634ALT

BRAND	PART #	DESCRIPTION	LINK
-------	--------	-------------	------

Erie Strayer	57634ALT	Double Solenoid Electric Over Air Valve	link
--------------	----------	---	----------------------

BRAND	PART #	DESCRIPTION	LINK
-------	--------	-------------	------

Erie Strayer	57636	Bellows Repair Kit	link
--------------	-------	--------------------	----------------------



57636



62969

BRAND	PART #	DESCRIPTION	LINK
-------	--------	-------------	------

Erie Strayer	62969	Solenoid Valve for Nose Cone/Plug	link
--------------	-------	-----------------------------------	----------------------

BRAND	PART #	DESCRIPTION	LINK
-------	--------	-------------	------

Liddell	900049010	Repair Kit for Single Solenoid Valves	link
---------	-----------	---------------------------------------	----------------------



900049010



900050003

BRAND	PART #	DESCRIPTION	LINK
-------	--------	-------------	------

Liddell	900050003	Single Solenoid Electric Over Air Valve	link
---------	-----------	---	----------------------

SOLENOID VALVES

no pic

BRAND	PART #	DESCRIPTION	LINK
Liddell	900053002	120VAC Brass Solenoid Valve	link

BRAND	PART #	DESCRIPTION	LINK
Liddell	900107002	Solenoid 6 Ft DIN Cable For ASCO Valves	link

no pic



900053007

BRAND	PART #	DESCRIPTION	LINK
Liddell	900053007	1in Turbo Solenoid Valve	link



2120214701

BRAND	PART #	DESCRIPTION	LINK
RexCon	2120214701	Single Solenoid Electric Over Air Valve	link

2120214601



BRAND	PART #	DESCRIPTION	LINK
RexCon	2120214601	Double Solenoid Electric Over Air Valve	link

BRAND	PART #	DESCRIPTION	LINK
RexCon	2120210901	Double Solenoid Valve	link



2120210901

2120210801



BRAND	PART #	DESCRIPTION	LINK
RexCon	2120210801	Single Solenoid Valve	link

SOLENOID VALVES

2120211101

BRAND	PART #	DESCRIPTION	LINK
RexCon	2120211101	Solenoid Coil	link



2120211201



BRAND	PART #	DESCRIPTION	LINK
RexCon	2120211201	Pilot Valve Solenoid	link

5576480

BRAND	PART #	DESCRIPTION	LINK
Johnson-Ross	5576480	Single Solenoid Electric Over Air Valve	link



no pic

BRAND	PART #	DESCRIPTION	LINK
Johnson-Ross	PS001424	Air Valve Repair Kit for 55-76480	link

BRAND	PART #	DESCRIPTION	LINK
Johnson-Ross	PS001423	110V Pilot Valve Coil Assembly for 55-76480	link

PS001423



5576479



BRAND	PART #	DESCRIPTION	LINK
Johnson-Ross	5576479	Double Solenoid Electric Over Air Inching Valve	link

BRAND	PART #	DESCRIPTION	LINK
Johnson-Ross	PS001425	Electric Over Air Valve Repair Kit	link

no pic

SOLENOID VALVES



BRAND	PART #	DESCRIPTION	LINK
Johnson-Ross	PS001109	110V Pilot Valve Coil Assembly for 55-76479	link



BRAND	PART #	DESCRIPTION	LINK
Johnson-Ross	5576539	Double Solenoid Electric Over Air Non-Inching Valve	link



BRAND	PART #	DESCRIPTION	LINK
Johnson-Ross	5577236	2-Way Pilot Operated Air Valve Assembly - .375	link

BRAND	PART #	DESCRIPTION	LINK
Johnson-Ross	5577820	Coil Repair Kit	link no pic



BRAND	PART #	DESCRIPTION	LINK
Johnson-Ross	5576457	2-Way Pilot Operated Air Valve Assembly - 3/4in Ports	link



BRAND	PART #	DESCRIPTION	LINK
Johnson-Ross	5576609	1in Dust Collector Valve	link

SOLENOID VALVES

BRAND	PART #	DESCRIPTION	LINK
Johnson-Ross	5577823	Repair Kit For SC8353G052	link no pic



BRAND	PART #	DESCRIPTION	LINK
Johnson-Ross	5576925	Electric Over Air Valve	link

BRAND	PART #	DESCRIPTION	LINK
Johnson-Ross	5547674	Electric Over Air Solenoid Valve	link



BRAND	PART #	DESCRIPTION	LINK
Johnson-Ross	5577319	Over Air Inching Solenoid Valve	link



BRAND	PART #	DESCRIPTION	LINK
Johnson-Ross	5589747	Repair Kit for Double Solenoid Valves	link



BRAND	PART #	DESCRIPTION	LINK
Johnson-Ross	K343124	Spool Only for L6653921153	link

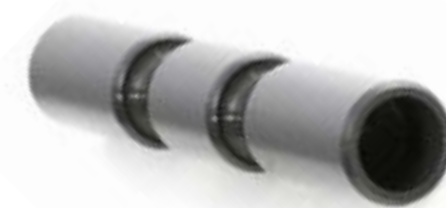

BRAND	PART #	DESCRIPTION	LINK
Johnson-Ross	5576767	Single Solenoid Valve	link



SOLENOID VALVES

5576933	BRAND	PART #	DESCRIPTION	LINK
---------	-------	--------	-------------	------



Johnson-Ross	5576933	Double Solenoid Valve	link
--------------	---------	-----------------------	----------------------

BRAND	PART #	DESCRIPTION	LINK
-------	--------	-------------	------

Johnson-Ross	5547682	Single Solenoid Electric Over Air Valve	link
--------------	---------	---	----------------------



5547682



5547677

BRAND	PART #	DESCRIPTION	LINK
-------	--------	-------------	------

Johnson-Ross	5576933	Double Solenoid Valve	link
--------------	---------	-----------------------	----------------------



5576840

BRAND	PART #	DESCRIPTION	LINK
-------	--------	-------------	------

Johnson-Ross	5576840	Single Solenoid Electric Over Air Valve with Sub-Base	link
--------------	---------	---	----------------------



5573067

BRAND	PART #	DESCRIPTION	LINK
-------	--------	-------------	------

Johnson-Ross	5573067	Batch Plant Solenoid Valve Repair Kit	link
--------------	---------	---------------------------------------	----------------------

5574143



BRAND	PART #	DESCRIPTION	LINK
-------	--------	-------------	------

Johnson-Ross	5574143	Air Valve Shock Pad	link
--------------	---------	---------------------	----------------------

SOLENOID VALVES

BRAND	PART #	DESCRIPTION	LINK
-------	--------	-------------	------

Johnson-Ross	5547707	Double Solenoid Electric Over Air Inching Valve with Sub-Base	link
--------------	---------	---	----------------------

5547707



036962

BRAND	PART #	DESCRIPTION	LINK
-------	--------	-------------	------

Vince Hagan	036962	Double Solenoid Electric Over Air Valve with Subplate	link
-------------	--------	---	----------------------

036964

BRAND	PART #	DESCRIPTION	LINK
-------	--------	-------------	------

Vince Hagan	036964	SMC Single Solenoid Electric Over Air Valve with Subbase	link
-------------	--------	--	----------------------



031380

BRAND	PART #	DESCRIPTION	LINK
-------	--------	-------------	------

Vince Hagan	031380	Double Solenoid Electric Over Air Valve without Subbase	link
-------------	--------	---	----------------------

BRAND	PART #	DESCRIPTION	LINK
-------	--------	-------------	------

Vince Hagan	031381	Single Solenoid Electric Over Air Valve without Subbase	link
-------------	--------	---	----------------------



031381

SOLENOID VALVES

031960



BRAND	PART #	DESCRIPTION	LINK
Vince Hagan	031960	Solenoid	link

031964



BRAND	PART #	DESCRIPTION	LINK
Vince Hagan	031964	Valve Solenoid	link

101820



BRAND	PART #	DESCRIPTION	LINK
Vince Hagan	101820	Jet Pulse Dust Collector 1/8in Solenoid Valve	link

V5V81



BRAND	PART #	DESCRIPTION	LINK
WAM	V5V81	Double Solenoid Electric Over Air Valve	link

no pic

BRAND	PART #	DESCRIPTION	LINK
WAM	V5V41	Spring Return Solenoid Valve for V.FS350 to V.FS400 Valves	link

BRAND	PART #	DESCRIPTION	LINK
WAM	BOB11050	Solenoid Coil For V5V81 and V5V41 - 110VAC 8W	link



BOB11050

SOLENOID VALVES

BRAND	PART #	DESCRIPTION	LINK
Vince Hagan	BOB02450	24VAC Solenoid Coil 8W	link

no pic

no pic

BRAND	PART #	DESCRIPTION	LINK
Vince Hagan	BOB024VDC15W	Solenoid Coil 24VDC 15W	link

SPROCKETS & CHAIN

H60P14



BRAND	PART #	DESCRIPTION	LINK
Stephens	H60P14	Turnhead Sprocket	link

BRAND	PART #	DESCRIPTION	LINK
Stephens	P1118	Sprocket Bushing	link



P1118

NO PIC

BRAND	PART #	DESCRIPTION	LINK
Stephens	J60	60 Riveted Chain For TurnHead	link

BRAND	PART #	DESCRIPTION	LINK
Liddell	LD999992	Radial Stacker Sprocket	link

NO PIC

NO PIC

BRAND	PART #	DESCRIPTION	LINK
Stephens	LD999993	Gear Box Sprocket	link

900182003

BRAND	PART #	DESCRIPTION	LINK
Liddell	900182003	Sprocket	link



NO PIC

BRAND	PART #	DESCRIPTION	LINK
Stephens	LD152244	Chain for Radial Stacker - Per Foot	link

SPROCKETS & CHAIN

BRAND	PART #	DESCRIPTION	LINK
Stephens	LD152266	Master Link for Radial Stacker Chain	link

NO PIC

NO PIC

BRAND	PART #	DESCRIPTION	LINK
Martin	50BS45X134	Sprocket	link

80SF25

BRAND	PART #	DESCRIPTION	LINK
Martin	80SF25	Sprocket	link



TRANSITION ADAPTERS & EMERGENCY SLIDES



BRAND	PART #	DESCRIPTION	LINK
Stephens	WPC8	Butterfly Valve Flange	link



BRAND	PART #	DESCRIPTION	LINK
Stephens	WPC10	Cement Silo Boot Flange with Shroud Ring for 10 inch Bray Butterfly Valve	link



BRAND	PART #	DESCRIPTION	LINK
Stephens	WPTES8	8in Emergency Slide	link

BRAND	PART #	DESCRIPTION	LINK
Stephens	WPTES10	10in Emergency Slide	link

NO PIC

BRAND	PART #	DESCRIPTION	LINK
Stephens	ES12	12in Emergency Slide Gate	link

NO PIC

BRAND	PART #	DESCRIPTION	LINK
Stephens	WPT8	Cement Silo Transition Flange from Square Gate to 8in Bray	link

NO PIC



BRAND	PART #	DESCRIPTION	LINK
Stephens	WPT10	Silo Transition Flange from Rotary Gate to 10in Butterfly Valve	link

TRANSITION ADAPTERS & EMERGENCY SLIDES

BRAND	PART #	DESCRIPTION	LINK
Stephens	WPT12	Cement Silo Transition Flange	link

NO PIC

BRAND	PART #	DESCRIPTION	LINK
Stephens	S2WTF	Dust Collector Transition Flange	link

NO PIC



BRAND	PART #	DESCRIPTION	LINK
Stephens	C1212	Cement Silo Boot Flange with Shroud Ring for 12in Bray Butterfly Valve	link



BRAND	PART #	DESCRIPTION	LINK
Stephens	FF12	Cement Silo Flat Straight Flange for 12 inch Bray Butterfly Valve	link

BRAND	PART #	DESCRIPTION	LINK
Belgrade	10UNVBVMATFLGC	10in Cement Silo Boot Flange	link



BRAND	PART #	DESCRIPTION	LINK
Belgrade	7401464608	Transition Flange from Rotary Gate to 8" Butterfly Valve with 8" Boot Flange	link

NO PIC

TRANSITION ADAPTERS & EMERGENCY SLIDES

NO PIC

BRAND	PART #	DESCRIPTION	LINK
Stephens	6RD6SQTRANS	Transiton Wam 6" Slide Gate To 6" Round For Wam Auger	link

BRAND	PART #	DESCRIPTION	LINK
-------	--------	-------------	------

Stephens	74014646010	Cement Silo Transition Flange from Rotary Gate to 10" Butterfly Valve with 10" Boot Flange	link
----------	-------------	--	----------------------

NO PIC



BRAND	PART #	DESCRIPTION	LINK
Con-E-Co Aftermarket	PL0026	Flat Straight Flange for 10in Bray Butterfly Valve	link

PL0012



BRAND	PART #	DESCRIPTION	LINK
Stephens	PL0012	Flat Straight 12in Flange	link



BRAND	PART #	DESCRIPTION	LINK
Con-E-Co Aftermarket	CF0017	8in Cement Silo Boot Flange for 8in Butterfly Valve	link

CF0007



BRAND	PART #	DESCRIPTION	LINK
Con-E-Co Aftermarket	CF0007	Cement Silo Boot Flange	link

TRANSITION ADAPTERS & EMERGENCY SLIDES

CH0014



BRAND	PART #	DESCRIPTION	LINK
-------	--------	-------------	------

Con-E-Co Aftermarket	CH0014	Cement Silo Boot 12in Flange	link
----------------------	--------	------------------------------	----------------------

740146460



BRAND	PART #	DESCRIPTION	LINK
-------	--------	-------------	------

Con-E-Co Aftermarket	740146460	Cement Silo Transition Flange from Rotary Gate to 10in Butterfly Valve to 10in Bray Butterfly Valve	link
----------------------	-----------	---	----------------------

BRAND	PART #	DESCRIPTION	LINK
-------	--------	-------------	------

Liddell	R01002416	24in x 16in Square Flange Transition	link
---------	-----------	--------------------------------------	----------------------

NO PIC

NO PIC

BRAND	PART #	DESCRIPTION	LINK
-------	--------	-------------	------

Liddell	R10000400100	Plant Leg Transition with Knife Gate	link
---------	--------------	--------------------------------------	----------------------

BRAND	PART #	DESCRIPTION	LINK
-------	--------	-------------	------

Liddell	R02000663	12in x 12in Round to Square Transition Mating Flange	link
---------	-----------	--	----------------------

NO PIC

NO PIC

BRAND	PART #	DESCRIPTION	LINK
-------	--------	-------------	------

Liddell	R02000664	18in x 18in Round to Square Transition Mating Flange	link
---------	-----------	--	----------------------

NO PIC

BRAND	PART #	DESCRIPTION	LINK
Stephens	2306036	Batch Plant Collector Hopper	link

BRAND	PART #	DESCRIPTION	LINK
Stephens	23530	Old Style Conveyor Discharge Hopper for 30 Inch Wide Conveyors	link

NO PIC

NO PIC

BRAND	PART #	DESCRIPTION	LINK
Stephens	MB1002000200	297 Cubic Feet 15 Ton 10ft x 10ft Hopper	link

BRAND	PART #	DESCRIPTION	LINK
Stephens	2340C2136	Conveyor Discharge Hopper - Old Century 36" Belt	link

NO PIC



4440717001

BRAND	PART #	DESCRIPTION	LINK
Johnson Ross	4440717001	Tilt Mixer Gob Hopper Assembly	link

PAGE
INTENTIONALLY
LEFT BLANK

VIBRATORS

NO PIC	BRAND	PART #	DESCRIPTION	LINK
	Stephens	VS190HS	Pneumatic Vibrator, Turbine, Silent, Built-in Muffler	link

BRAND	PART #	DESCRIPTION	LINK
Stephens	VS250HS	4in Pneumatic Turbine Vibrator	link

NO PIC



BRAND	PART #	DESCRIPTION	LINK
Stephens	VS320HS	High Speed Pneumatic Silent Turbine Vibrator	link

VS380HS



BRAND	PART #	DESCRIPTION	LINK
Stephens	VS380HS	Pneumatic Silent Turbine Vibrator - High Speed	link

NO PIC

BRAND	PART #	DESCRIPTION	LINK
Stephens	VS510HS	Pneumatic Vibrator	link

BRAND	PART #	DESCRIPTION	LINK
Stephens	55114	Model 55 Series Piston Vibrator	link

55114



NO PIC

BRAND	PART #	DESCRIPTION	LINK
Stephens	552	Model 50 Series Piston Vibrator	link

VIBRATORS

BRAND	PART #	DESCRIPTION	LINK
Stephens	2P2003	Three Phase Electric Vibrator	link



2P2003

NO PIC

BRAND	PART #	DESCRIPTION	LINK
Stephens	2P4501	Single Phase Electric Vibrator	link

BRAND	PART #	DESCRIPTION	LINK
Belgrade	VS190AIRVIB	Pneumatic Vibrator	link

VS190AIRVIB



VS380AIRVIB

BRAND	PART #	DESCRIPTION	LINK
Belgrade	VS380AIRVIB	Pneumatic Silent Turbine Vibrator	link

BRAND	PART #	DESCRIPTION	LINK
Con-E-Co Aftermarket	146541	Pneumatic Vibrator	link

NO PIC

146500



BRAND	PART #	DESCRIPTION	LINK
Con-E-Co Aftermarket	146500	Pneumatic Rotary Vibrator	link

VIBRATORS

146502



BRAND	PART #	DESCRIPTION	LINK
Con-E-Co Aftermarket	146502	Silent Turbine Vibrator	link

1102986



BRAND	PART #	DESCRIPTION	LINK
Con-E-Co Aftermarket	1102986	High Frequency Electric Vibrator	link

59537



BRAND	PART #	DESCRIPTION	LINK
Erie Strayer	59537	High Speed Pneumatic Silent Turbine Vibrator	link

59538



BRAND	PART #	DESCRIPTION	LINK
Erie Strayer	59538	Pneumatic Silent Turbine Vibrator	link

NO PIC

BRAND	PART #	DESCRIPTION	LINK
Johnson Ross	5576733	Pneumatic Ball Vibrator	link

BRAND	PART #	DESCRIPTION	LINK
Johnson Ross	5545402	1.25in Piston Vibrator	link

NO PIC

VIBRATORS

5576739



BRAND	PART #	DESCRIPTION	LINK
Johnson Ross	5576739	Piston Vibrator	link

5577139



BRAND	PART #	DESCRIPTION	LINK
Johnson Ross	5577139	Silent Operating Concrete Plant Bin Vibrator-Piston	link

BRAND	PART #	DESCRIPTION	LINK
Liddell	900041002	Silent Operating Concrete Plant Bin Vibrator-Piston	link

900041002



1190889



BRAND	PART #	DESCRIPTION	LINK
McNeilus	1190889	Vibrator-Piston For Aggregate Batcher	link

BRAND	PART #	DESCRIPTION	LINK
McNeilus	1145977	High Frequency Vibrator	link

NO PIC

740201676



BRAND	PART #	DESCRIPTION	LINK
McNeilus	740201676	Pneumatic Rotary Vibrator	link

VIBRATORS



740201675	BRAND	PART #	DESCRIPTION	LINK
	McNeilus	740201675	Silent Turbine Vibrator	link



740201677	BRAND	PART #	DESCRIPTION	LINK
	McNeilus	740201677	Pneumatic Silent Turbine Vibrator	link



1102985	BRAND	PART #	DESCRIPTION	LINK
	McNeilus	1102985	High Frequency Electric Vibrator	link



740201674	BRAND	PART #	DESCRIPTION	LINK
	McNeilus	740201674	Three Phase Electric Vibrator	link



740201678	BRAND	PART #	DESCRIPTION	LINK
	McNeilus	740201678	Piston Vibrator	link

	BRAND	PART #	DESCRIPTION	LINK
	McNeilus	1237127	Pneumatic Vibrator	link

NO PIC

VIBRATORS



2120213801	BRAND	PART #	DESCRIPTION	LINK
	RexCon	2120213801	Pneumatic Rotary Vibrator	link



964495	BRAND	PART #	DESCRIPTION	LINK
	Vince Hagan	964495	Bin Vibrator Piston	link



964496	BRAND	PART #	DESCRIPTION	LINK
	Vince Hagan	964496	Silent Operating Concrete Plant Bin Vibrator-Piston	link



960427	BRAND	PART #	DESCRIPTION	LINK
	Vince Hagan	960427	High Speed Pneumatic Silent Turbine Vibrator	link

	BRAND	PART #	DESCRIPTION	LINK
	Houston Vibrator	841057X	T-Slot Flat Surface Mounting Plate with Fasteners	link

NO PIC

NO PIC

	BRAND	PART #	DESCRIPTION	LINK
	Houston Vibrator	829008	Head Gasket for BV-425	link



	BRAND	PART #	DESCRIPTION	LINK
	Houston Vibrator	BV150IMPTEFK	IMP/TEFK Impacting Pneumatic Piston Vibrator with Tef-Kote bore	link

NO PIC

VIBRATORS

NO PIC		BRAND	PART #	DESCRIPTION	LINK
		Houston Vibrator	BV175IMP	Impacting Pneumatic Piston Vibrator	link
BRAND	PART #	DESCRIPTION	LINK	NO PIC	
Houston Vibrator	BV225IMPLONG	IMP/Long Impacting Long Stroke Pneumatic Piston Vibrator	link		
NO PIC		BRAND	PART #	DESCRIPTION	LINK
		Houston Vibrator	BV225QILONG	Quiet Impact Pneumatic Piston Vibrator Long Stroke with rubber tip	link
BRAND	PART #	DESCRIPTION	LINK	NEED INFO	
Houston Vibrator	BV350IMP	Impacting Pneumatic Piston Vibrator	link		
NO PIC		BRAND	PART #	DESCRIPTION	LINK
		Houston Vibrator	BV425IMP	Impacting Pneumatic Piston Vibrator	link
BRAND	PART #	DESCRIPTION	LINK	NO PIC	
Houston Vibrator	MVSI361050	Three Phase Rotary Electric Vibrator	link		
NO PIC		BRAND	PART #	DESCRIPTION	LINK
		Houston Vibrator	BV225IMP	Impacting Pneumatic Piston Vibrator	link
BRAND	PART #	DESCRIPTION	LINK	NO PIC	
Houston Vibrator	BV150IMP	Impacting Pneumatic Piston Vibrator	link		

VIBRATORS

NO PIC		BRAND	PART #	DESCRIPTION	LINK
		Vibco	BVS160	Pneumatic Silent Turbine Vibrator	link
					
NO PIC		BRAND	PART #	DESCRIPTION	LINK
		Vibco	BVS190PL	Pneumatic Silent Turbine Vibrator - Plastic Housing	link
NO PIC		BRAND	PART #	DESCRIPTION	LINK
		Vibco	BVS250	Pneumatic Rotary Vibrator	link
					
NO PIC		BRAND	PART #	DESCRIPTION	LINK
		Vibco	BVS320	Silent Pneumatic Turbine Vibrator	link
					
NO PIC		BRAND	PART #	DESCRIPTION	LINK
		Vibco	BVS380	Silent Pneumatic Turbine Vibrator	link
					
NO PIC		BRAND	PART #	DESCRIPTION	LINK
		Vibco	BVS510	Silent Pneumatic Turbine Vibrator	link
NO PIC		BRAND	PART #	DESCRIPTION	LINK
		Vibco	VS100	Silent Pneumatic Turbine Vibrator	link
					

VIBRATORS



VS190

BRAND	PART #	DESCRIPTION	LINK
Vibco	VS190	Silent Pneumatic Turbine Vibrator	link

VS250

BRAND	PART #	DESCRIPTION	LINK
Vibco	VS250	Silent Pneumatic Turbine Vibrator	link



NO PIC

BRAND	PART #	DESCRIPTION	LINK
Vibco	VS250HS	Silent Pneumatic Turbine Vibrator - High Speed - Quick Starting	link

BRAND	PART #	DESCRIPTION	LINK
Vibco	VS320HS	Pneumatic Silent Turbine Vibrator - High Speed - Quick Starting	link



VS320HS



VS380

BRAND	PART #	DESCRIPTION	LINK
Vibco	VS380	Pneumatic Silent Turbine Vibrator	link

VS380HS

BRAND	PART #	DESCRIPTION	LINK
Vibco	VS380HS	Pneumatic Silent Turbine Vibrator - High Speed, Quick Starting	link



VIBRATORS

BRAND	PART #	DESCRIPTION	LINK
Vibco	VS510	Pneumatic Silent Turbine Vibrator	link



VS510

NO PIC

BRAND	PART #	DESCRIPTION	LINK
Vibco	VS510HS	Silent Pneumatic Turbine Vibrator - High Speed - Quick Starting	link

BRAND	PART #	DESCRIPTION	LINK
Vibco	VS510AL	Pneumatic Silent Turbine Vibrator - Aluminum Housing	link

NO PIC

NO PIC

BRAND	PART #	DESCRIPTION	LINK
Vibco	CCF2000	Pneumatic High Force Silent Turbine Vibrator	link

BRAND	PART #	DESCRIPTION	LINK
Vibco	MLT250	Turbine Vibrator with Muffler and Inlet Barb	link

MLT250



MLTSS190

BRAND	PART #	DESCRIPTION	LINK
Vibco	MLTSS190	Pneumatic Sanitary Silent Turbine Vibrator	link

BRAND	PART #	DESCRIPTION	LINK
Vibco	BV60	Pneumatic Ball Vibrator	link

NO PIC

Vibco BV60 Pneumatic Ball Vibrator

VIBRATORS

BV380



BRAND	PART #	DESCRIPTION	LINK
Vibco	BV380	Pneumatic Ball Vibrator	link

BRAND	PART #	DESCRIPTION	LINK
Vibco	V320	Pneumatic Ball Vibrator	link



NO PIC

BRAND	PART #	DESCRIPTION	LINK
Vibco	50112	Model 50 Series Piston Vibrator	link

BRAND	PART #	DESCRIPTION	LINK
Vibco	502	Model 50 Series Piston Vibrator	link



NO PIC

BRAND	PART #	DESCRIPTION	LINK
Vibco	502S	Model 50 Series Air Cushioned Piston Vibrator	link

BRAND	PART #	DESCRIPTION	LINK
Vibco	502L	Impacting Pneumatic Piston Vibrator	link

NO PIC

NO PIC

BRAND	PART #	DESCRIPTION	LINK
Vibco	503	Model 50 Series Piston Vibrator	link

VIBRATORS

BRAND	PART #	DESCRIPTION	LINK
Vibco	503S	Model 50 Series Air Cushioned Piston Vibrator	link

NO PIC



BRAND	PART #	DESCRIPTION	LINK
Vibco	55114	Model 55 Series Piston Vibrator	link



BRAND	PART #	DESCRIPTION	LINK
Vibco	55150	Model 55 Series Piston Vibrator	link

BRAND	PART #	DESCRIPTION	LINK
Vibco	55150S	Model 55 Series Air Cushioned Piston Vibrator	link



BRAND	PART #	DESCRIPTION	LINK
Vibco	552	Model 50 Series Piston Vibrator	link

NO PIC



BRAND	PART #	DESCRIPTION	LINK
Vibco	552S	Model 55 Series Air Cushioned Piston Vibrator	link

BRAND	PART #	DESCRIPTION	LINK
Vibco	553S	Model 55 Series Air Cushioned Piston Vibrator	link

NO PIC

VIBRATORS

101EM



BRAND	PART #	DESCRIPTION	LINK
Vibco	101EM	1in Pneumatic End Mounted Piston Vibrator	link

BRAND	PART #	DESCRIPTION	LINK	NO PIC
Vibco	SVR4000	High Frequency Silent Pneumatic Vibrator	link	



BRAND	PART #	DESCRIPTION	LINK
Vibco	B320	Hydraulic Turbine Vibrator	link



BRAND	PART #	DESCRIPTION	LINK
Vibco	SCR200	Silent Adjustable Electric Vibrator	link

BRAND	PART #	DESCRIPTION	LINK	NO PIC
Vibco	SCR1000	Silent Adjustable Electric Vibrator	link	

BRAND	PART #	DESCRIPTION	LINK	NO PIC
Vibco	SPR80	Silent Small Electric Vibrator	link	

VIBRATORS

BRAND	PART #	DESCRIPTION	LINK	NO PIC
Vibco	2P1003	Three Phase Large Electric Vibrator	link	

BRAND	PART #	DESCRIPTION	LINK
Vibco	2P1501	Single Phase Large Electric Vibrator	link

BRAND	PART #	DESCRIPTION	LINK
Vibco	2P2003	Three Phase Heavy Duty Electric Vibrator	link



BRAND	PART #	DESCRIPTION	LINK
Vibco	2P200H03	Three Phase Heavy Duty Electric Vibrator	link

BRAND	PART #	DESCRIPTION	LINK	NO PIC
Vibco	2P4501	Single Phase Heavy Duty Electric Vibrator	link	

2P4503



BRAND	PART #	DESCRIPTION	LINK
Vibco	2P4503	Three Phase Heavy Duty Electric Vibrator	link

BRAND	PART #	DESCRIPTION	LINK	NO PIC
Vibco	2P8001	Single Phase Heavy Duty Electric Vibrator	link	

VIBRATORS

2P8003



BRAND	PART #	DESCRIPTION	LINK
Vibco	2P8003	Three Phase Heavy Duty Electric Vibrator	link

BRAND	PART #	DESCRIPTION	LINK
Vibco	US450T	High Frequency Electric Vibrator	link

US450T



US700



BRAND	PART #	DESCRIPTION	LINK
Vibco	US700	High Frequency Electric Vibrator	link

BRAND	PART #	DESCRIPTION	LINK
Vibco	US900	High Frequency Electric Vibrator	link

US900



US1600



BRAND	PART #	DESCRIPTION	LINK
Vibco	US1600	High Frequency Electric Vibrator	link

BRAND	PART #	DESCRIPTION	LINK
Vibco	DC60	High Frequency Electric Vibrator	link

NO PIC

VIBRATORS

DC500



BRAND	PART #	DESCRIPTION	LINK
Vibco	DC500	12VDC Electric Vibrator	link

NO PIC

BRAND	PART #	DESCRIPTION	LINK
Vibco	VMC4503	Three Phase Silent Large Electric Vibrator	link

BRAND	PART #	DESCRIPTION	LINK
Vibco	VMM3	Vibrator Mounting Bracket	link

NO PIC

NO PIC

BRAND	PART #	DESCRIPTION	LINK
Vibco	VMC3	Clamp-On Bracket	link

BRAND	PART #	DESCRIPTION	LINK
Vibco	VMW61	Car Shaker Wedge Bracket	link

NO PIC

NO PIC

BRAND	PART #	DESCRIPTION	LINK
Vibco	UM2	Vibrator Mounting Bracket	link

BRAND	PART #	DESCRIPTION	LINK
Vibco	VSM2	Vibrator Mounting Bracket	link

NO PIC

NO PIC

BRAND	PART #	DESCRIPTION	LINK
Vibco	VSM5	Vibrator Mounting Bracket	link

NO PIC	BRAND	PART #	DESCRIPTION	LINK
	Vibco	3X5CHIN	Mounting Channel	link

BRAND	PART #	DESCRIPTION	LINK
-------	--------	-------------	------

Vibco	4X625CH24	24in Mounting Channel for Vibrator	link	NO PIC
-------	-----------	------------------------------------	----------------------	--------

BRAND	PART #	DESCRIPTION	LINK
-------	--------	-------------	------

NO PIC	Vibco	BK012	Vibrator Brush Kit	link
--------	-------	-------	--------------------	----------------------

BRAND	PART #	DESCRIPTION	LINK
-------	--------	-------------	------

Vibco	BK009	Vibrator Brush Kit	link	NO PIC
-------	-------	--------------------	----------------------	--------

BRAND	PART #	DESCRIPTION	LINK
-------	--------	-------------	------

NO PIC	Vibco	900US10BS	Vibrator Brush Cap (US-450T/700/900/1600)	link
--------	-------	-----------	---	----------------------

BRAND	PART #	DESCRIPTION	LINK
-------	--------	-------------	------

Vibco	BK002C	Vibrator Brush Kit	link
-------	--------	--------------------	----------------------



BRAND	PART #	DESCRIPTION	LINK
-------	--------	-------------	------

NO PIC	Vibco	48VM10211A	Stator Assembly for 2P-450-3 Electric Vibrator	link
--------	-------	------------	--	----------------------

BRAND	PART #	DESCRIPTION	LINK
-------	--------	-------------	------

Vibco	SPC	15V Speed Control Adjuster for Electric Vibrators with Variable AC Voltage Supply	link
-------	-----	---	----------------------



BRAND	PART #	DESCRIPTION	LINK
-------	--------	-------------	------

NO PIC	Vibco	42VM117	Speed Control Adjuster For Electric Vibrators	link
--------	-------	---------	---	----------------------

PAGE
INTENTIONALLY
LEFT BLANK

HANDLES & FLANGES

NO PIC

BRAND	PART #	DESCRIPTION	LINK
Stephens	510	Bag House Handle	link

BRAND	PART #	DESCRIPTION	LINK
Stephens	12358	Bag House I-Bolts	link

NO PIC

NO PIC

BRAND	PART #	DESCRIPTION	LINK
Stephens	TKFL18	Flange	link

NO PIC

BRAND	PART #	DESCRIPTION	LINK
Stephens	TKFL38	Flange	link

NO PIC

BRAND	PART #	DESCRIPTION	LINK
Stephens	TKFL12	Flange	link

NO PIC

BRAND	PART #	DESCRIPTION	LINK
Stephens	TKFL34	Flange	link

NO PIC

BRAND	PART #	DESCRIPTION	LINK
Stephens	TKFL1	Flange	link

NO PIC

BRAND	PART #	DESCRIPTION	LINK
Stephens	TKFL112	Flange	link

NO PIC

BRAND	PART #	DESCRIPTION	LINK
Stephens	TKFL2	Flange	link

HANDLES & FLANGES

1238522



BRAND	PART #	DESCRIPTION	LINK
Con-E-Co Aftermarket	1238522	T-Handle Lift and Turn Compression Latch	link

0100615



BRAND	PART #	DESCRIPTION	LINK
Con-E-Co Aftermarket	0100615	Dust Collector Eye Bolt - 3/8in-16 x 1-3/4in	link

BRAND	PART #	DESCRIPTION	LINK
Liddell	401380011	Actuator Handle Kit for 16-Inch Slide	link

NO PIC

NO PIC

BRAND	PART #	DESCRIPTION	LINK
WAM	CM3B	Butterfly Valve Lever-Offset for Wam VFS350-400	link

BRAND	PART #	DESCRIPTION	LINK
WAM	20955421A	Spline Bushing	link

NO PIC



CM4

BRAND	PART #	DESCRIPTION	LINK
WAM	CM4	Butterfly Valve Offset Bent Handle Lever for VFS100 to VFS300	link

WATER METERS

NO PIC

BRAND	PART #	DESCRIPTION	LINK
Badger Meter	WCM67772002A	1in M7600 ModMAG Meter Only	link

BRAND	PART #	DESCRIPTION	LINK
Badger Meter	WCM67772003A	2in M7600 ModMAG Meter Only	link

NO PIC

WCM67772003B



BRAND	PART #	DESCRIPTION	LINK
Badger Meter	WCM67772003B	2in M7600 ModMAG Meter & Butterfly Valve Combination (Scalable Electronics)	link

BRAND	PART #	DESCRIPTION	LINK
Badger Meter	WCM258113	2in Butterfly Valve Only with Operator	link

NO PIC



WCM67772004A

BRAND	PART #	DESCRIPTION	LINK
Badger Meter	WCM67772004A	3in M7600 Magnetoflow Meter Only	link

WCM67772004B



BRAND	PART #	DESCRIPTION	LINK
Badger Meter	WCM67772004B	3in M7600 ModMAG Meter & Butterfly Valve Combination (Scalable Electronics)	link

WATER METERS

NO PIC

BRAND	PART #	DESCRIPTION	LINK
Badger Meter	WCM258114	3in Butterfly Valve Only with Operator	link

NO PIC

BRAND	PART #	DESCRIPTION	LINK
Badger Meter	WCM67772005A	4in M7600 ModMAG Meter Only	link

BRAND	PART #	DESCRIPTION	LINK
-------	--------	-------------	------

Badger Meter	WCM258115	4in Butterfly Valve Only with Operator	link
--------------	-----------	--	----------------------

NO PIC

67527001



BRAND	PART #	DESCRIPTION	LINK
Badger Meter	67527001	M7600 ModMAG Meter PC Board Only	link

BRAND	PART #	DESCRIPTION	LINK
-------	--------	-------------	------

Badger Meter	WCM2551301000	ATC Water Controller in Enclosure	link
--------------	---------------	-----------------------------------	----------------------

NO PIC

NO PIC

BRAND	PART #	DESCRIPTION	LINK
Badger Meter	WCM2551301200	ATC Water Batch Controller with Run/Hold Switch	link

WCM258131

BRAND	PART #	DESCRIPTION	LINK
Badger Meter	WCM258131	2in Turbo/Butterfly Valve Combination with PFT-4E Scalable Transmitter	link



WATER METERS

	BRAND	PART #	DESCRIPTION	LINK
NO PIC	Badger Meter	WCM258130	2in Turbo/Butterfly Valve Combination with PFT-3E Unscalable Transmitter	link

BRAND	PART #	DESCRIPTION	LINK
Badger Meter	WCM258129	2in Turbo/Butterfly Valve Combination with PFT-3E And Meter Mount PC-200 Controller	link

NO PIC



WCM258090

BRAND	PART #	DESCRIPTION	LINK
Badger Meter	WCM258090	2in Turbo/Butterfly Valve Combination with PFT-3E Unscalable Transmitter	link

WCM258094

BRAND	PART #	DESCRIPTION	LINK
Badger Meter	WCM258094	2in Turbo Meter Only with PFT-4E Scalable Transmitter	link



	BRAND	PART #	DESCRIPTION	LINK
NO PIC	Badger Meter	WCM258142	2in Bronze Head Assembly with PFT-3E Unscaled Transmitter	link

BRAND	PART #	DESCRIPTION	LINK
Badger Meter	WCM258143	2in Bronze Head Assembly with PFT-4E Scalable Transmitter	link

NO PIC

WATER METERS

BRAND	PART #	DESCRIPTION	LINK
Badger Meter	WCM258013	2in Turbo Meter Only No Transmitter	link



WCM258013

	BRAND	PART #	DESCRIPTION	LINK
NO PIC	Badger Meter	WCM258003	2in Turbo Meter with Non-Resettable Totalizer	link

NO PIC

BRAND	PART #	DESCRIPTION	LINK
Badger Meter	WCM258118	Vane Actuator with Solenoid	link

BRAND	PART #	DESCRIPTION	LINK
Badger Meter	WCM258135	3in Turbo/Butterfly Valve Combination with PFT-4E Scalable Transmitter	link



WCM258135

	BRAND	PART #	DESCRIPTION	LINK
NO PIC	Badger Meter	WCM258133	3in Turbo/Butterfly Valve Combination with PFT-3E And Meter Mount PC-200 Controller	link

WATER METERS

NO PIC

BRAND	PART #	DESCRIPTION	LINK
Badger Meter	WCM258091	3in Turbo Meter Only with PFT-3E Unscaled Transmitter	link

WCM258095



BRAND	PART #	DESCRIPTION	LINK
Badger Meter	WCM258095	3in Turbo Meter Only with PFT-4E Scalable Transmitter	link

NO PIC

BRAND	PART #	DESCRIPTION	LINK
Badger Meter	WCM258144	3in Bronze Head Assembly with PFT-3E Unscaled Transmitter	link

WCM258145



BRAND	PART #	DESCRIPTION	LINK
Badger Meter	WCM258145	3in Bronze Head Assembly with PFT-4E Scalable Transmitter	link

NO PIC

BRAND	PART #	DESCRIPTION	LINK
Badger Meter	WCM258014	3in Turbo Meter Only with No Transmitter	link

BRAND	PART #	DESCRIPTION	LINK
Badger Meter	WCM252057	3in Turbo Meter with Non-Resettable Totalizer	link

NO PIC

WATER METERS

BRAND	PART #	DESCRIPTION	LINK
Badger Meter	WCM258139	4in Turbo/Butterfly Valve Combination with PFT-4E Scalable Transmitter	link

NO PIC

NO PIC

BRAND	PART #	DESCRIPTION	LINK
Badger Meter	WCM258138	4in Turbo/Butterfly Valve Combination with PFT-3E Unscalable Transmitter	link

BRAND	PART #	DESCRIPTION	LINK
Badger Meter	WCM258137	4in Turbo/Butterfly Valve Combination with PFT-3E And Meter Mount PC-200 Controller	link

NO PIC

WCM258140



BRAND	PART #	DESCRIPTION	LINK
Badger Meter	WCM258140	4in Turbo Meter Only with PFT-3E Unscaled Transmitter	link

WCM258141

BRAND	PART #	DESCRIPTION	LINK
Badger Meter	WCM258141	4in Turbo Meter Only with PFT-4E Scalable Transmitter	link



NO PIC

BRAND	PART #	DESCRIPTION	LINK
Badger Meter	WCM258146	4in Bronze Head Assembly with PFT-3E Unscaled Transmitter	link

WATER METERS

NO PIC	BRAND	PART #	DESCRIPTION	LINK
	Badger Meter	WCM258147	4in Bronze Head Assembly with PFT-4E Scalable Transmitter	link

BRAND	PART #	DESCRIPTION	LINK	NO PIC
Badger Meter	WCM258015	4in Turbo Meter Only No Transmitter	link	

NO PIC	BRAND	PART #	DESCRIPTION	LINK
	Badger Meter	WCM252075	4in Turbo Meter with Non-Resettable Totalizer	link

NO PIC	BRAND	PART #	DESCRIPTION	LINK
	Badger Meter	55300022	Bypass O-Ring	link

BRAND	PART #	DESCRIPTION	LINK	NO PIC
Badger Meter	34869001	Bypass Valve	link	

NO PIC	BRAND	PART #	DESCRIPTION	LINK
	Badger Meter	34870001	Bypass Valve	link

BRAND	PART #	DESCRIPTION	LINK	NO PIC
Badger Meter	34897001	Bypass Locking Ring	link	

34899003	BRAND	PART #	DESCRIPTION	LINK
	Badger Meter	34899003	Head Gasket for 2in and 3in Meters	link

WATER METERS

BRAND	PART #	DESCRIPTION	LINK	56331003
Badger Meter	56331003	Head Gasket for 4in Meters	link	

22559043	BRAND	PART #	DESCRIPTION	LINK
	Badger Meter	22559043	Head Tetra Seal for 2in and 3in Meters	link

BRAND	PART #	DESCRIPTION	LINK	NO PIC
Badger Meter	22559044	Head Tetra Seal for 4in Meters	link	

57341003	BRAND	PART #	DESCRIPTION	LINK
	Badger Meter	57341003	Nose Cone	link

BRAND	PART #	DESCRIPTION	LINK	NO PIC
Badger Meter	55300110	Register Base O-Ring	link	

NO PIC	BRAND	PART #	DESCRIPTION	LINK
	Badger Meter	22886012	Register Base Retaining Ring	link

BRAND	PART #	DESCRIPTION	LINK	NO PIC
Badger Meter	57337001	Register Base Spacer	link	

WATER METERS

34900002



BRAND	PART #	DESCRIPTION	LINK
Badger Meter	34900002	Retaining Ring for 2in Meter	link

BRAND	PART #	DESCRIPTION	LINK
-------	--------	-------------	------

Badger Meter	34900001	Retaining Ring for 3in Meter	link	NO PIC
--------------	----------	------------------------------	----------------------	--------

34900003



BRAND	PART #	DESCRIPTION	LINK
Badger Meter	34900003	Retaining Ring for 4in Meter	link

56998034



BRAND	PART #	DESCRIPTION	LINK
-------	--------	-------------	------

Badger Meter	56998034	2 Pole Rotor and Spindle for 2in Meter	link
--------------	----------	--	----------------------

56998035



BRAND	PART #	DESCRIPTION	LINK
Badger Meter	56998035	2 Pole Rotor and Spindle for 3in Meter	link

BRAND	PART #	DESCRIPTION	LINK
-------	--------	-------------	------

Badger Meter	56998036	2 Pole Rotor and Spindle for 4in Meter	link	NO PIC
--------------	----------	--	----------------------	--------

56998046



BRAND	PART #	DESCRIPTION	LINK
Badger Meter	56998046	4 Pole Rotor & Spindle for 2 in Meter	link

WATER METERS

56998047



BRAND	PART #	DESCRIPTION	LINK
Badger Meter	56998047	4 Pole Rotor and Spindle for 3in Meters	link

56998048



BRAND	PART #	DESCRIPTION	LINK
Badger Meter	56998048	4 Pole Rotor and Spindle for 4in Meters	link

BRAND	PART #	DESCRIPTION	LINK
-------	--------	-------------	------

Badger Meter	62965001	Scaler Board Only: AC/DC Version	link
--------------	----------	----------------------------------	----------------------



62965001

NO PIC

BRAND	PART #	DESCRIPTION	LINK
Badger Meter	62975001	Straightening Vane Assembly for 2in Turbo Meter	link

BRAND	PART #	DESCRIPTION	LINK
-------	--------	-------------	------

Badger Meter	58620004	Straightening Vane Assembly for 3in Turbo Meter	link
--------------	----------	---	----------------------

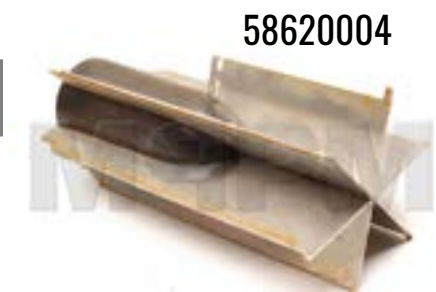

58620004

NO PIC

BRAND	PART #	DESCRIPTION	LINK
Badger Meter	56340007	Straightening Vane Assembly for 4in Turbo Meter	link

BRAND	PART #	DESCRIPTION	LINK
-------	--------	-------------	------

Badger Meter	58639001	Reed Switch (For PM-5 & MSE-1 Series Transmitters)	link
--------------	----------	--	----------------------



58639001

WATER METERS

WCM250243



BRAND	PART #	DESCRIPTION	LINK
Badger Meter	WCM250243	2in Companion Flange Gasket	link

BRAND	PART #	DESCRIPTION	LINK
Badger Meter	WCM250244	3in Companion Flange Gasket	link

NO PIC

BRAND	PART #	DESCRIPTION	LINK
Badger Meter	WCM250245	4in Companion Flange Gasket	link

BRAND	PART #	DESCRIPTION	LINK
Badger Meter	WCM250241	3in Threaded Pipe Companion Flange	link

NO PIC

NO PIC

BRAND	PART #	DESCRIPTION	LINK
Badger Meter	WCM250242	4in Threaded Pipe Companion Flange	link

BRAND	PART #	DESCRIPTION	LINK
Badger Meter	WCM250067	Bolt With Nut: 5/8in x 4in	link

NO PIC

WCM258082



BRAND	PART #	DESCRIPTION	LINK
Badger Meter	WCM258082	Vane Actuator	link

WATER METERS

BRAND	PART #	DESCRIPTION	LINK
Badger Meter	WCM258232	2in Butterfly Valve	link



WCM25823

WCM258233



BRAND	PART #	DESCRIPTION	LINK
Badger Meter	WCM258233	3in Butterfly Valve	link

BRAND	PART #	DESCRIPTION	LINK
Badger Meter	WCM255524	4-Way Solenoid Valve	link



WCM255524

NO PIC

BRAND	PART #	DESCRIPTION	LINK
Badger Meter	WCM253309	1/4in Filter Regulator	link

BRAND	PART #	DESCRIPTION	LINK
Badger Meter	WCM250251	0-60 PSI Gauge	link

NO PIC

NO PIC

BRAND	PART #	DESCRIPTION	LINK
Badger Meter	WCM258083	1/4in Speed Control Valve	link

BRAND	PART #	DESCRIPTION	LINK
Badger Meter	WCM250351	Mounting Bracket for 4-Way Solenoid	link

NO PIC

WATER METERS

58751001



BRAND	PART #	DESCRIPTION	LINK
Badger Meter	58751001	Nema 4X Enclosure	link

BRAND	PART #	DESCRIPTION	LINK
Badger Meter	WCM250252	2in Diaphragm Valve	link

NO PIC

BRAND	PART #	DESCRIPTION	LINK
Badger Meter	WCM250253	3in Diaphragm Valve	link

NO PIC

BRAND	PART #	DESCRIPTION	LINK
Badger Meter	WCM250254	4in Diaphragm Valve	link

NO PIC

BRAND	PART #	DESCRIPTION	LINK
Badger Meter	WCM250287	3in Diaphragm Valve and Seal Kit	link

NO PIC

BRAND	PART #	DESCRIPTION	LINK
Badger Meter	WCM258085	2in Diaphragm Internal Parts Kit	link

NO PIC

BRAND	PART #	DESCRIPTION	LINK
Badger Meter	WCM250237	3-Way Solenoid Valve	link

NO PIC

WATER METERS

BRAND	PART #	DESCRIPTION	LINK
Badger Meter	WCM255164	5/8in RCDL Meter Only 120 Deg. Max Fluid Temp	link

NO PIC

WCM255117



BRAND	PART #	DESCRIPTION	LINK
Badger Meter	WCM255117	5/8in RCDL Meter Only 250 Deg. Max Fluid Temp	link

BRAND	PART #	DESCRIPTION	LINK
Badger Meter	WCM255136	3/4in RCDL Meter Only 120 Deg. Max Fluid Temp	link

NO PIC

WCM255124



BRAND	PART #	DESCRIPTION	LINK
Badger Meter	WCM255124	3/4in RCDL Meter Only 250 Deg. Max Fluid Temp	link

BRAND	PART #	DESCRIPTION	LINK
Badger Meter	WCM255121	1in RCDL Meter Only 120 Deg. Max Fluid Temp	link



WCM255121

NO PIC

BRAND	PART #	DESCRIPTION	LINK
Badger Meter	WCM255186	1in RCDL Meter Only 250 Deg. Max Fluid Temp	link

WCM255133

BRAND	PART #	DESCRIPTION	LINK
Badger Meter	WCM255133	1-1/2in RCDL Meter Only 120 Deg. Max Fluid Temp	link



WATER METERS

NO PIC

BRAND	PART #	DESCRIPTION	LINK
Badger Meter	WCM250906	1-1/2in RCDL Meter Only 120 Deg./Corr. Resist. Internals	link

BRAND	PART #	DESCRIPTION	LINK
-------	--------	-------------	------

Badger Meter	WCM255185	3/4in RCDL Meter Only 120 Deg. Max Fluid Temp	link
--------------	-----------	---	----------------------

NO PIC

WCM255015



BRAND	PART #	DESCRIPTION	LINK
Badger Meter	WCM255015	2in RCDL Meter Only 120 Deg. Max Fluid Temp	link

BRAND	PART #	DESCRIPTION	LINK
-------	--------	-------------	------

Badger Meter	WCM255197	5/8in RCDL Meter PL 100 Deg. Max Fluid Temp	link
--------------	-----------	---	----------------------

NO PIC

NO PIC

BRAND	PART #	DESCRIPTION	LINK
-------	--------	-------------	------

Badger Meter	WCM255183	5/8in RCDL Meter PL100 Deg./Corr. Resist. Internals	link
--------------	-----------	---	----------------------

BRAND	PART #	DESCRIPTION	LINK
-------	--------	-------------	------

Badger Meter	WCM255162	3/4in RCDL Meter PL100 Deg. Max Fluid Temp	link
--------------	-----------	--	----------------------

NO PIC

BRAND	PART #	DESCRIPTION	LINK
-------	--------	-------------	------

NO PIC

Badger Meter	WCM255035	3/4in RCDL Meter with PFT-1E 120 Deg. Max Fluid Temp	link
--------------	-----------	--	----------------------

WATER METERS

NO PIC

BRAND	PART #	DESCRIPTION	LINK
Badger Meter	WCM255118	5/8in RCDL Meter with PFT-1E 250 Deg. Max Fluid Temp	link

NO PIC

BRAND	PART #	DESCRIPTION	LINK
-------	--------	-------------	------

Badger Meter	WCM255119	3/4in RCDL Meter with PFT-1E 250 Deg. Max Fluid Temp	link
--------------	-----------	--	----------------------

BRAND	PART #	DESCRIPTION	LINK
-------	--------	-------------	------

Badger Meter	WCM255169	1in RCDL Meter with PFT-1E 120 Deg. Max Fluid Temp	link
--------------	-----------	--	----------------------

NO PIC

BRAND	PART #	DESCRIPTION	LINK
-------	--------	-------------	------

NO PIC

Badger Meter	WCM255190	1in RCDL Meter with PFT-1E 250 Deg. Max Fluid Temp	link
--------------	-----------	--	----------------------

BRAND	PART #	DESCRIPTION	LINK
-------	--------	-------------	------

Badger Meter	WCM255170	1-1/2in RCDL Meter with PFT-1E 120 Deg. Max Fluid Temp	link
--------------	-----------	--	----------------------

NO PIC

BRAND	PART #	DESCRIPTION	LINK
-------	--------	-------------	------

NO PIC

Badger Meter	WCM255127	Unscaled Transmitter (3-Wire)	link
--------------	-----------	-------------------------------	----------------------

BRAND	PART #	DESCRIPTION	LINK
-------	--------	-------------	------

Badger Meter	59010003	PFT-2 Unscaled Transmitter (2-Wire)	link
--------------	----------	-------------------------------------	----------------------

NO PIC

WCM255120



BRAND	PART #	DESCRIPTION	LINK
-------	--------	-------------	------

Badger Meter	WCM255120	PFT-1E Electronic Scalable Transmitter	link
--------------	-----------	--	----------------------

WATER METERS

NO PIC

BRAND	PART #	DESCRIPTION	LINK
Badger Meter	WCM2552050001	Scaler Board Transmitter	link

BRAND	PART #	DESCRIPTION	LINK
Badger Meter	WCM255182	Non-Reset. Totalizer 250 Deg. Max Fluid Temp	link

NO PIC

BRAND	PART #	DESCRIPTION	LINK
Badger Meter	WCM255193	Non-Reset. Totalizer 250 Deg. Max Fluid Temp	link

NO PIC

BRAND	PART #	DESCRIPTION	LINK
Badger Meter	WCM255192	Non-Reset. Totalizer 250 Deg. Max Fluid Temp	link

NO PIC

BRAND	PART #	DESCRIPTION	LINK
Badger Meter	WCM2551820001	Non-Reset. Totalizer 120 Deg. Max Fluid Temp	link

NO PIC

BRAND	PART #	DESCRIPTION	LINK
Badger Meter	WCM2552020001	Model 35 Non-Resetable Register	link

NO PIC

BRAND	PART #	DESCRIPTION	LINK
Badger Meter	WCM2551930001	Non-Reset. Totalizer 120 Deg. Max Fluid Temp	link

NO PIC

BRAND	PART #	DESCRIPTION	LINK
Badger Meter	WCM2551920001	Non-Reset. Totalizer 120 Deg. Max Fluid Temp	link

NO PIC

WATER METERS

BRAND	PART #	DESCRIPTION	LINK
Badger Meter	WCM2551890001	Non-Reset. Totalizer 120 Deg. Max Fluid Temp	link

NO PIC

NO PIC

BRAND	PART #	DESCRIPTION	LINK
Badger Meter	58908006	Chamber & Disc Assembly, LCP, Model 25 RCDL	link

BRAND	PART #	DESCRIPTION	LINK
Badger Meter	33334009	1/2in Plastic Connector for RCDL Model 25 Disc Meters	link

NO PIC

NO PIC

BRAND	PART #	DESCRIPTION	LINK
Badger Meter	33334029	Chamber & Disc Assembly, Noryl, Model 35 RCDL	link

BRAND	PART #	DESCRIPTION	LINK
Badger Meter	33334016	Chamber & Disc Assembly, Noryl, Model 70 RCDL	link

33334016



NO PIC

BRAND	PART #	DESCRIPTION	LINK
Badger Meter	63079002	Chamber & Disc Assembly, LCP, Model 70 RCDL	link

BRAND	PART #	DESCRIPTION	LINK
Badger Meter	33334017	Chamber & Disc Assembly, Noryl, Model 120 RCDL	link

33334017



NO PIC

BRAND	PART #	DESCRIPTION	LINK
Badger Meter	63175002	Plastic Connector for RCDL Model 120 Disc Meters	link

WATER METERS

33334028



BRAND	PART #	DESCRIPTION	LINK
Badger Meter	33334028	Chamber & Disc Assembly, Noryl, Model 170 RCDL	link

BRAND	PART #	DESCRIPTION	LINK
Badger Meter	58540001	Retaining Strap, Model 25 & Model 35 RCDL	link NO PIC

NO PIC

BRAND	PART #	DESCRIPTION	LINK
Badger Meter	62695001	Retaining Clip, Model 25 RCDL	link

BRAND	PART #	DESCRIPTION	LINK
Badger Meter	62695002	Retaining Clip, Model 70 & Model 120 RCDL	link



NO PIC

BRAND	PART #	DESCRIPTION	LINK
Badger Meter	11071045	M25 Housing Gasket Model 25 RCDL	link

BRAND	PART #	DESCRIPTION	LINK
Badger Meter	11071033	M25 Housing Gasket Model 25 RCDL	link

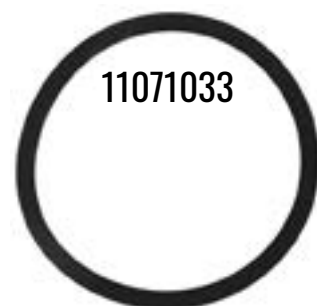

BRAND	PART #	DESCRIPTION	LINK
Badger Meter	59782001	Housing Gasket, Buna-N, Model 35 RCDL	link



WATER METERS

BRAND	PART #	DESCRIPTION	LINK
Badger Meter	58769001	Housing Gasket, Buna-N, Model 70 RCDL	link



BRAND	PART #	DESCRIPTION	LINK
Badger Meter	58769002	Housing Gasket, Viton, Model 70 RCDL	link



BRAND	PART #	DESCRIPTION	LINK
Badger Meter	62171002	Housing Gasket, Viton, Model 120 RCDL	link NO PIC

BRAND	PART #	DESCRIPTION	LINK
Badger Meter	62171001	Housing Gasket, EPDM, Model 120 RCDL	link



BRAND	PART #	DESCRIPTION	LINK
Badger Meter	59722001	Housing Gasket, EPDM, Model 170 RCDL	link NO PIC

NO PIC

BRAND	PART #	DESCRIPTION	LINK
Badger Meter	34333001	Screen, Recordall Model 25	link

BRAND	PART #	DESCRIPTION	LINK
Badger Meter	59805001	Screen, Model 35 RCDL	link NO PIC

NO PIC

BRAND	PART #	DESCRIPTION	LINK
Badger Meter	59186001	Screen, Model 70 RCDL (Low Temp.)	link

WATER METERS

NO PIC	BRAND	PART #	DESCRIPTION	LINK
	Badger Meter	62172001	Screen, Model 120 RCDL	link

BRAND	PART #	DESCRIPTION	LINK
Badger Meter	59720001	Screen, Model 170 RCDL	link



NO PIC	BRAND	PART #	DESCRIPTION	LINK
	Badger Meter	55058225	Fillister Head Screw 10-32 x 3/4in	link

BRAND	PART #	DESCRIPTION	LINK	NO PIC
Badger Meter	58852001	Cover / Transmitter	link	

NO PIC	BRAND	PART #	DESCRIPTION	LINK
	Badger Meter	58855001	Gasket / Transmitter	link

BRAND	PART #	DESCRIPTION	LINK	NO PIC
Badger Meter	58875001	Housing / Transmitter	link	

BRAND	PART #	DESCRIPTION	LINK	NO PIC
Badger Meter	34529001	Housing Bottom, Model 25 RCDL PVC	link	

WATER METERS

BRAND	PART #	DESCRIPTION	LINK
Badger Meter	62635005	Model 25 RCDL Housing Bottom	link



BRAND	PART #	DESCRIPTION	LINK
Badger Meter	59703006	Housing Bottom, Model 70 RCDL	link



BRAND	PART #	DESCRIPTION	LINK
Badger Meter	59784005	Housing Bottom, Model 35 RCDL	link



NO PIC	BRAND	PART #	DESCRIPTION	LINK
	Badger Meter	67632001	Gylon Connector Assembly, Model 25, 5/8	link

BRAND	PART #	DESCRIPTION	LINK	NO PIC
Badger Meter	67632003	Connector Assembly, Model 25, 3/4in-Gylon (2 per Package)	link	

NO PIC	BRAND	PART #	DESCRIPTION	LINK
	Badger Meter	67632005	Connector Assembly, Model 70, 1in-Gylon (2 per Package)	link

BRAND	PART #	DESCRIPTION	LINK	NO PIC
Badger Meter	67632009	Bronze Connector Assembly, Model 120, 1	link	

WATER METERS

	BRAND	PART #	DESCRIPTION	LINK
NO PIC	Badger Meter	67632010	Connector Assembly, Model 170, 2in-Gylon (2 per Package)	link

	BRAND	PART #	DESCRIPTION	LINK
	Badger Meter	WCM258157	3/4in M25 RCDL Meter/Solenoid Valve Combination with PFT-2E Unscaled Transmitter	link
NO PIC				

	BRAND	PART #	DESCRIPTION	LINK
NO PIC	Badger Meter	WCM258151	3/4in M25 RCDL Meter/Solenoid Valve Combination with PFT-2E Unscaled Transmitter	link

	BRAND	PART #	DESCRIPTION	LINK
	Badger Meter	WCM258226	3/4in M25 RCDL Meter/Solenoid Valve Combination with PFT-1E Scalable Transmitter	link
NO PIC				

	BRAND	PART #	DESCRIPTION	LINK
NO PIC	Badger Meter	WCM258148	3/4in M25 RCDL Meter/Solenoid Valve Combination with PFT-1E Scalable Transmitter	link

	BRAND	PART #	DESCRIPTION	LINK
	Badger Meter	WCM258152	1in M70 RCDL Meter/Solenoid Valve Combination with PFT-2E Unscaled Transmitter	link
NO PIC				

WATER METERS

	BRAND	PART #	DESCRIPTION	LINK
	Badger Meter	WCM258158	1in M70 RCDL Meter/Solenoid Valve Combination with PFT-2E Unscaled Transmitter	link
NO PIC				

	BRAND	PART #	DESCRIPTION	LINK
NO PIC	Badger Meter	WCM258149	1in M70 RCDL Meter/Solenoid Valve Combination with PFT-1E Scalable Transmitter	link

	BRAND	PART #	DESCRIPTION	LINK
	Badger Meter	WCM258227	1in M70 RCDL Meter/Solenoid Valve Combination with PFT-1E Scalable Transmitter	link
NO PIC				

	BRAND	PART #	DESCRIPTION	LINK
NO PIC	Badger Meter	WCM250199	3/4in Solenoid Valve	link

	BRAND	PART #	DESCRIPTION	LINK
	Badger Meter	WCM250331	1in Solenoid Valve	link
NO PIC				

	BRAND	PART #	DESCRIPTION	LINK
NO PIC	Badger Meter	WCM252061	1-1/2in Solenoid Valve	link

	BRAND	PART #	DESCRIPTION	LINK
	Badger Meter	62833003	LCD Counter in Enclosure Model ER-9 (Single)	link



WATER METERS

NO PIC

BRAND	PART #	DESCRIPTION	LINK
Badger Meter	WCM250756	LCD Counter ER-9 Meter Mounted (2in & 3in Turbo)	link

BRAND	PART #	DESCRIPTION	LINK
Badger Meter	WCM250940	LCD Counter ER-9 Meter Mounted (4in Turbo)	link

NO PIC

67868002



BRAND	PART #	DESCRIPTION	LINK
Badger Meter	67868002	PC-200 Panel Mount Batch Controller	link

258095



BRAND	PART #	DESCRIPTION	LINK
Stephens	258095	LCD Counter ER-9 Meter Mounted (4in Turbo)	link

258141



BRAND	PART #	DESCRIPTION	LINK
Stephens	258141	4in Turbo Meter Only with Scalable Transmitter	link

912BPM112CA



BRAND	PART #	DESCRIPTION	LINK
Stephens	912BPM112CA	Air Valve-Single Solenoid - 120VAC	link

250256



BRAND	PART #	DESCRIPTION	LINK
Stephens	250256	Scaler Board	link

WATER METERS

258072



BRAND	PART #	DESCRIPTION	LINK
Stephens	258072	2 Pole Rotor and Spindle for 2in Meter	link

258047



BRAND	PART #	DESCRIPTION	LINK
Stephens	258047	4 Pole Rotor and Spindle for 2in Meter	link

258073



BRAND	PART #	DESCRIPTION	LINK
Stephens	258073	2 Pole Rotor and Spindle for 3in Meter	link

258048



BRAND	PART #	DESCRIPTION	LINK
Stephens	258048	4 Pole Rotor and Spindle for 3in Meters	link

01999400041



BRAND	PART #	DESCRIPTION	LINK
Besser	01999400041	2in Turbo-Butterfly Valve Combo with Scalable Transmitter	link

241050



BRAND	PART #	DESCRIPTION	LINK
Con-E-Co Replacement	241050	2in Turbo Meter with PFT-4E Scalable Transmitter	link

WATER METERS

0072500



BRAND	PART #	DESCRIPTION	LINK
Con-E-Co Replacement	0072500	Scaler Board	link

1142354



BRAND	PART #	DESCRIPTION	LINK
Con-E-Co Replacement	1142354	Scalable Transmitter for 2in and 3in Meters	link



0072509

BRAND	PART #	DESCRIPTION	LINK
Con-E-Co Replacement	0072509	Head Gasket for 2in and 3in Meters	link

BRAND	PART #	DESCRIPTION	LINK
Con-E-Co Replacement	0072510	Head Tetra Seal for 2in and 3in Meters	link



0072510



0072511

BRAND	PART #	DESCRIPTION	LINK
Con-E-Co Replacement	0072511	4 Pole Rotor and Spindle for 2in Meter	link

BRAND	PART #	DESCRIPTION	LINK
Con-E-Co Replacement	0072508	4 Pole Rotor and Spindle for 3in Meters	link



0072508



140850

BRAND	PART #	DESCRIPTION	LINK
Con-E-Co Replacement	140850	2in Pipe Companion Flange Gasket	link

WATER METERS



1103984



BRAND	PART #	DESCRIPTION	LINK
Con-E-Co Replacement	1103983	2in Badger Magnetoflow Meter	link
Con-E-Co Replacement	1103984	3in Badger Magnetoflow Meter	link
Con-E-Co Replacement	241062	4in Mag Meter for Concrete Applications	link

BRAND	PART #	DESCRIPTION	LINK
Con-E-Co Replacement	140860	3in Pipe Companion Flange Gasket	link



140860

NO PIC

BRAND	PART #	DESCRIPTION	LINK
Con-E-Co Replacement	140870	4in Pipe Companion Flange Gasket	link

WATER METERS



141950

BRAND	PART #	DESCRIPTION	LINK
Con-E-Co Replacement	141950	5in Pipe Companion Flange Gasket	link



140790

BRAND	PART #	DESCRIPTION	LINK
Con-E-Co Replacement	140790	2in Threaded Pipe Companion Flange	link
Con-E-Co Replacement	140800	3in Threaded Pipe Companion Flange	link
Con-E-Co Replacement	141990	4in Threaded Pipe Companion Flange	link
Con-E-Co Replacement	141930	5in Threaded Pipe Companion Flange	link
Con-E-Co Replacement	141932	6in Threaded Pipe Companion Flange	link
Con-E-Co Replacement	140815	8in Threaded Pipe Companion Flange	link

WATER METERS



141920

BRAND	PART #	DESCRIPTION	LINK
Con-E-Co Replacement	140791	2in Slip-On Weld Flange	link
Con-E-Co Replacement	140810	3in Slip-On Weld Flange	link
Con-E-Co Replacement	141921	4in Slip-On Weld Flange	link
Con-E-Co Replacement	141920	5in Slip-On Weld Flange	link
Con-E-Co Replacement	141933	6in Slip-On Weld Flange	link
Con-E-Co Replacement	140812	8in Slip-On Weld Flange	link

BRAND	PART #	DESCRIPTION	LINK
Erie Strayer	66478	Head Gasket for 4in Meters	link



66478

NO PIC

BRAND	PART #	DESCRIPTION	LINK
Erie Strayer	66479	Head Tetra Seal for 4in Meters	link

BRAND	PART #	DESCRIPTION	LINK
Erie Strayer	66458	Scaler Board	link



66458

WATER METERS



63325

BRAND	PART #	DESCRIPTION	LINK
Erie Strayer	64769	1in Mag Meter for Concrete Applications	link
Erie Strayer	63382	Magnetoflow Meter Only	link
Erie Strayer	63325	Magnetoflow Meter Only	link
Erie Strayer	63383	4in Mag Meter for Concrete Applications	link

BRAND	PART #	DESCRIPTION	LINK
Liddell	900076003	4in Turbo Meter Only with Scalable Transmitter	link



900076003



900076010

BRAND	PART #	DESCRIPTION	LINK
Liddell	900076010	4 Pole Rotor and Spindle for 3in Meters	link

BRAND	PART #	DESCRIPTION	LINK
Liddell	400884006	2in Demco Butterfly Valve	link



400884006



74072500

BRAND	PART #	DESCRIPTION	LINK
McNeilus	74072500	Water Meter Scaler Board	link

BRAND	PART #	DESCRIPTION	LINK
McNeilus	1142407	Turbo Meter Only with Unscaled Transmitter	link

NO PIC

WATER METERS

1142408



BRAND	PART #	DESCRIPTION	LINK
McNeilus	1142408	Turbo Meter Only with Scalable Transmitter	link



10072503

BRAND	PART #	DESCRIPTION	LINK
McNeilus	10072503	2in Pipe Companion Flange Gasket	link



10072504

BRAND	PART #	DESCRIPTION	LINK
McNeilus	10072504	3in Pipe Companion Flange Gasket	link

BRAND	PART #	DESCRIPTION	LINK
NO PIC	McNeilus	4in Pipe Companion Flange Gasket	link

BRAND	PART #	DESCRIPTION	LINK
McNeilus	1236873	5in Companion Flange Gasket	link

1236873



BRAND	PART #	DESCRIPTION	LINK
NO PIC	McNeilus	3in Threaded Pipe Companion Flange	link

WATER METERS

NO PIC	BRAND	PART #	DESCRIPTION	LINK
	McNeilus	740101312	4in Threaded Pipe Companion Flange	link

BRAND	PART #	DESCRIPTION	LINK	NO PIC
McNeilus	740101313	6in Threaded Pipe Companion Flange	link	



740101653

BRAND	PART #	DESCRIPTION	LINK
McNeilus	740101653	10in Flat Straight Flange for 10in Bray Butterfly Valve	link

740101653B



BRAND	PART #	DESCRIPTION	LINK
McNeilus	740101653B	Cement Silo Boot Flange	link

1108913



BRAND	PART #	DESCRIPTION	LINK
McNeilus	1108910	2in Slip-On Weld Flange	link
McNeilus	1108911	3in Slip-On Weld Flange	link
McNeilus	1108912	4in Slip-On Weld Flange	link
McNeilus	1108913	5in Slip-On Weld Flange	link
McNeilus	1108914	6in Slip-On Weld Flange	link
McNeilus	1228231	8in Slip-On Weld Flange	link

BRAND	PART #	DESCRIPTION	LINK
McNeilus	260101306	1/2in Ball Valve	link



260101306

WATER METERS

BRAND	PART #	DESCRIPTION	LINK	NO PIC
McNeilus	1237177	Keystone 3in Butterfly Valve with Double Acting Actuator	link	

1237091



BRAND	PART #	DESCRIPTION	LINK
McNeilus	1237091	.125in Adjustable Flow Control Air Valve Exhaust Muffler	link

BRAND	PART #	DESCRIPTION	LINK	NO PIC
McNeilus	1237176	Keystone 2in Butterfly Valve	link	



1237178

BRAND	PART #	DESCRIPTION	LINK
McNeilus	1237178	Keystone 3in Butterfly Valve	link

2980217856

BRAND	PART #	DESCRIPTION	LINK
RexCon	2980217856	2in Turbo Meter with PFT-4E Scalable Transmitter	link



1121011470

BRAND	PART #	DESCRIPTION	LINK
RexCon	1121011470	4 Pole Rotor and Spindle for 2in Meter	link

BRAND	PART #	DESCRIPTION	LINK
RexCon	1121011439	Head Tetra Seal for 2in and 3in Meters	link



1121011439

WATER METERS



1121011452

BRAND	PART #	DESCRIPTION	LINK
RexCon	1121011452	Head Gasket for 2in and 3in Meters	link

BRAND	PART #	DESCRIPTION	LINK
RexCon	2980217756	Turbo Meter Only with Scalable Transmitter	link

2980217756



1121011471

BRAND	PART #	DESCRIPTION	LINK
RexCon	1121011471	4 Pole Rotor and Spindle for 3in Meters	link

BRAND	PART #	DESCRIPTION	LINK
RexCon	1121011428	Straightening Vane Assembly for 3in Turbo Meter	link

1121011428



2980023100

BRAND	PART #	DESCRIPTION	LINK
RexCon	2980023100	Scaler Board	link

BRAND	PART #	DESCRIPTION	LINK
RexCon	1121011422	Scalable Transmitter for 2in and 3in Meters	link

1121011422



2121109653

BRAND	PART #	DESCRIPTION	LINK
RexCon	2121109653	Magnetoflow Meter Only	link

WATER METERS

5573126



BRAND	PART #	DESCRIPTION	LINK
Johnson Ross	5573126	4in Turbo Meter Only with Scalable Transmitter	link



5545256

BRAND	PART #	DESCRIPTION	LINK
Johnson Ross	5545256	Head Gasket for 4in Meters	link

BRAND	PART #	DESCRIPTION	LINK
Johnson Ross	5588487	Head Tetra Seal for 4in Meters	link

NO PIC



5589782

BRAND	PART #	DESCRIPTION	LINK
Johnson Ross	5589782	Turbo Meter Only with Scalable Transmitter	link

BRAND	PART #	DESCRIPTION	LINK
Johnson Ross	5571699	4 Pole Rotor and Spindle for 3in Meters	link



5571699

NO PIC

BRAND	PART #	DESCRIPTION	LINK
Johnson Ross	5574230	2in Bronze Head Assembly with Scalable Transmitter	link

BRAND	PART #	DESCRIPTION	LINK
Johnson Ross	5572872	2in Turbo Meter with PFT-4E Scalable Transmitter	link

5572872



WATER METERS



5576886

BRAND	PART #	DESCRIPTION	LINK
Johnson Ross	5576886	4 Pole Rotor and Spindle for 2in Meter	link

BRAND	PART #	DESCRIPTION	LINK
Johnson Ross	5576928	3in Bronze Head Assembly with Scalable Transmitter	link



5576928

NO PIC

BRAND	PART #	DESCRIPTION	LINK
Johnson Ross	5577058	Clear Plastic Transmitter Cover	link

BRAND	PART #	DESCRIPTION	LINK
Johnson Ross	5577059	Transmitter Cover Gasket	link

NO PIC



5572787

BRAND	PART #	DESCRIPTION	LINK
Johnson Ross	5572787	Scaler Board	link

BRAND	PART #	DESCRIPTION	LINK
Johnson Ross	5577077	Scalable Transmitter for 2in and 3in Meters	link



5577077



5589724

BRAND	PART #	DESCRIPTION	LINK
Johnson Ross	5589724	Head Gasket for 2in and 3in Meters	link

WATER METERS

BRAND	PART #	DESCRIPTION	LINK
Johnson Ross	5585974	Head Tetra Seal for 2in and 3in Meters	link



5585974

971167



BRAND	PART #	DESCRIPTION	LINK
Vince Hagan	971167	2in Turbo Meter with PFT-4E Scalable Transmitter	link

BRAND	PART #	DESCRIPTION	LINK
Vince Hagan	971168	Turbo Meter Only with Scalable Transmitter	link

971168



971175

BRAND	PART #	DESCRIPTION	LINK
Vince Hagan	971175	4 Pole Rotor and Spindle for 2in Meter	link

BRAND	PART #	DESCRIPTION	LINK
Vince Hagan	971176	4 Pole Rotor and Spindle for 3in Meters	link



971176

971174



BRAND	PART #	DESCRIPTION	LINK
Vince Hagan	971174	Scaler Board	link

AERATION BLOWERS

AH1140

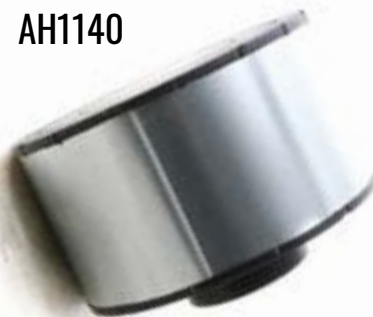

BRAND	PART #	DESCRIPTION	LINK
Stephens	AH1140	Blower Filter for Fuji Aeration Blower	link

PV6



BRAND	PART #	DESCRIPTION	LINK
Stephens	PV6	Aeration Blower Pressure Relief Valve	link

NO PIC

BRAND	PART #	DESCRIPTION	LINK
Stephens	25200200	Pressure Gauge	link

BRAND	PART #	DESCRIPTION	LINK
Stephens	8215B70	1.5in Valve AC 120/60, 110/50 D	link

NO PIC



VFZ601A7W

BRAND	PART #	DESCRIPTION	LINK
Stephens	VFZ601A7W	Regenerative Blower	link

T8BL



BRAND	PART #	DESCRIPTION	LINK
Stephens	T8BL	Air Gauge-2 inch Face 0-30 PSI 1/4 inch Back Mount	link

AERATION BLOWERS

RT021



BRAND	PART #	DESCRIPTION	LINK
C&W DustTech	RT021	Silencer Series F64 Air Intake Filter Element for 2 Inch Return Blower	link



RT013

BRAND	PART #	DESCRIPTION	LINK
C&W DustTech	RT013	Silencer Series F64 Air Intake Filter Element for 3 Inch Return Blower	link

RT019



BRAND	PART #	DESCRIPTION	LINK
C&W DustTech	RT019	Return Blower Filter with Housing	link

NO PIC

BRAND	PART #	DESCRIPTION	LINK
C&W DustTech	RT020	Batch Plant Recycle Return Blower	link

BRAND	PART #	DESCRIPTION	LINK
C&W DustTech	AMDD081	5 Hp Aeration Blower	link

NO PIC



146405

BRAND	PART #	DESCRIPTION	LINK
Con-E-Co Aftermarket	146405	Concrete Plant Aeration Blower Filter	link

AERATION BLOWERS



VFZ601A7W

BRAND	PART #	DESCRIPTION	LINK
Con-E-Co Aftermarket	145122	Regenerative Blower	link

BRAND	PART #	DESCRIPTION	LINK
-------	--------	-------------	------

Con-E-Co Aftermarket	145125	Plant Cement Aeration Blower Only - 7 HP	link	NO PIC
-------------------------	--------	---	----------------------	--------



PB0136

BRAND	PART #	DESCRIPTION	LINK
Con-E-Co Aftermarket	PB0136	Cement Aeration Blower 2" Relief Valve - Weighted	link

BRAND	PART #	DESCRIPTION	LINK
-------	--------	-------------	------

Con-E-Co Aftermarket	0111032	Blower Pressure Relief	link	NO PIC
-------------------------	---------	------------------------	----------------------	--------



0072484

BRAND	PART #	DESCRIPTION	LINK
-------	--------	-------------	------

Con-E-Co Aftermarket	0072484	Blower Filter Element - Small	link
-------------------------	---------	-------------------------------	----------------------

0111047



BRAND	PART #	DESCRIPTION	LINK
-------	--------	-------------	------

Con-E-Co Aftermarket	0111047	Blower Filter Element for 10 HP Rotron	link
-------------------------	---------	---	----------------------

AERATION BLOWERS

BRAND	PART #	DESCRIPTION	LINK
Erie Strayer	61726	Concrete Plant Aeration Blower Inlet Filter/Silencer	link

61726



BRAND	PART #	DESCRIPTION	LINK
Erie Strayer	63478	Blower Element Cartridge	link

63478



BRAND	PART #	DESCRIPTION	LINK
McNeilus	1237122	Aeration Blower Filter	link

1237122



BRAND	PART #	DESCRIPTION	LINK
McNeilus	1237015	Plant Aeration Blower Only - 5 HP	link

VFZ601A7W



BRAND	PART #	DESCRIPTION	LINK
McNeilus	1237516	Aeration Blower Assembly with Relief Valve and Filter	link

1237516



NO PIC

BRAND	PART #	DESCRIPTION	LINK
-------	--------	-------------	------

McNeilus	740111032	Blower Pressure Relief	link
----------	-----------	------------------------	----------------------

AERATION BLOWERS



0072484

BRAND	PART #	DESCRIPTION	LINK
McNeilus	74072484	Regenerative Blower Filter Element	link

74011047

BRAND	PART #	DESCRIPTION	LINK
McNeilus	74011047	Filter Element	link



NO PIC

BRAND	PART #	DESCRIPTION	LINK
Vince Hagan	031412	5 HP 3 Phase Aeration Blower	link

031425



BRAND	PART #	DESCRIPTION	LINK
Vince Hagan	031425	10HP Aeration Blower	link



031418

BRAND	PART #	DESCRIPTION	LINK
Vince Hagan	031418	Blower Filter Element for 5 HP Rotron	link

74011047



BRAND	PART #	DESCRIPTION	LINK
Vince Hagan	031810	Blower Filter Element for 10 HP Rotron	link

AERATION BLOWERS

081549



BRAND	PART #	DESCRIPTION	LINK
Vince Hagan	081549	Silo Top Blower	link

300221



BRAND	PART #	DESCRIPTION	LINK
Vince Hagan	300221	Baghouse Blower Motor Assembly	link

BRAND	PART #	DESCRIPTION	LINK
Fuji	VFC800A7W	Plant Blower Assembly-10 HP	link

NO PIC

NO PIC

BRAND	PART #	DESCRIPTION	LINK
Fuji	VFZ501A7W	Concrete Plant Aeration Blower Only - 2.7 HP 3-Phase	link

VFC600A7W



BRAND	PART #	DESCRIPTION	LINK
Fuji	VFC600A7W	Regenerative Blower 4.5 HP - Replaces VFC604A-7WS	link

VFZ601A7W



BRAND	PART #	DESCRIPTION	LINK
Fuji	VFZ601A7W	Regenerative Blower, 5.0 HP., 230/460V, 3-phase	link

AERATION BLOWERS



VFC508P2T

BRAND	PART #	DESCRIPTION	LINK
Fuji	VFC508P2T	Concrete Plant Aeration Blower Only-2.3 HP	link

BRAND	PART #	DESCRIPTION	LINK
Fuji	VFC700A7W	Cement Aeration Blower Only - 7 HP	link

NO PIC

BRAND	PART #	DESCRIPTION	LINK
Fuji	VFZ701A7W	Regenerative Blower	link

VFZ801A7W



BRAND	PART #	DESCRIPTION	LINK
Fuji	VFZ801A7W	Regenerative Blower	link

F67



BRAND	PART #	DESCRIPTION	LINK
Fuji	F67	Concrete Plant Aeration Blower Inlet Filter	link

BRAND	PART #	DESCRIPTION	LINK
Fuji	F89	Concrete Batch Plant Aeration Blower Inlet Filter	link

NO PIC

F45



BRAND	PART #	DESCRIPTION	LINK
Fuji	F45	Aeration Blower Inlet Filter	link

AERATION BLOWERS

FS67

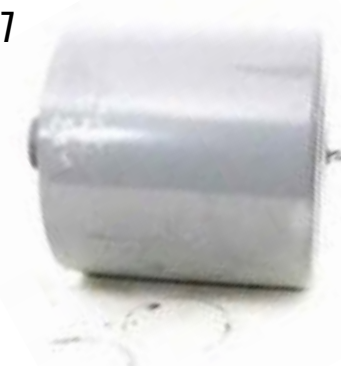

BRAND	PART #	DESCRIPTION	LINK
Fuji	FS67	Concrete Plant Aeration Blower Inlet Filter/Silencer	link

FS89E



BRAND	PART #	DESCRIPTION	LINK
Fuji	FS89E	Blower Element Cartridge	link

BRAND	PART #	DESCRIPTION	LINK
Fuji	PV5	Aeration Blower Pressure Relief Valve	link

NO PIC

PV6



BRAND	PART #	DESCRIPTION	LINK
Fuji	PV6	Concrete Batch Plant Aeration Blower Pressure Relief Valve	link

BRAND	PART #	DESCRIPTION	LINK
Fuji	PV7	Concrete Batch Plant Aeration Blower Pressure Relief Valve	link

NO PIC

PV8



BRAND	PART #	DESCRIPTION	LINK
Fuji	PV8	Concrete Batch Plant Aeration Blower Pressure Relief Valve	link

BRAND	PART #	DESCRIPTION	LINK
Fuji	RCKIT60	Rebuild Kit For Fuji Blower VFC600	link

NO PIC

TURNHEADS

F3U232N



BRAND	PART #	DESCRIPTION	LINK
Stephens	F3U232N	Turnhead 4-Bolt Flange Mount Bearing	link

BRAND	PART #	DESCRIPTION	LINK
Stephens	H60P14	Turnhead Sprocket	link



H60P14

NO PIC

BRAND	PART #	DESCRIPTION	LINK
Stephens	Q12	Turnhead Shaft Bushing	link

9007C54B2



BRAND	PART #	DESCRIPTION	LINK
Stephens	9007C54B2	Turnhead Limit Switch	link



9007MA18

BRAND	PART #	DESCRIPTION	LINK
Stephens	9007MA18	Turnhead Limit Switch Arm	link

BRAND	PART #	DESCRIPTION	LINK
Stephens	J60	Riveted Chain For TurnHead	link

NO PIC



TURNHEAD4

BRAND	PART #	DESCRIPTION	LINK
Stephens	TURNHEAD4	Concrete Batch Plant 4 Compartment Turnhead Assembly for Aggregate Bins	link

TURNHEADS

BRAND	PART #	DESCRIPTION	LINK
Stephens	TURNHEAD4PLATFORM	Turnhead Platform Assembly	link

NO PIC

NO PIC

BRAND	PART #	DESCRIPTION	LINK
Stephens	156HA556	Turnhead Gear Box Attachment	link

BRAND	PART #	DESCRIPTION	LINK
Stephens	23Q40L56	Turnhead Gear Reducer	link

NO PIC

NO PIC

BRAND	PART #	DESCRIPTION	LINK
Stephens	MOT121811556C	1/2 HP Turnhead Motor	link

BRAND	PART #	DESCRIPTION	LINK
Stephens	MLST00TH04KG83	Turnhead Liner Set	link

NO PIC

NO PIC

BRAND	PART #	DESCRIPTION	LINK
Con-E-Co Aftermarket	143948	Turnhead Urethane Liner Kit	link

280899



BRAND	PART #	DESCRIPTION	LINK
Con-E-Co Aftermarket	280899	Proximity Switch	link

0117042



BRAND	PART #	DESCRIPTION	LINK
Con-E-Co Aftermarket	0117042	Aggregate Bin Turnhead Proximity Sensor	link

TURNHEADS

1375386



BRAND	PART #	DESCRIPTION	LINK
Con-E-Co Aftermarket	1375386	1.25in Jaw Coupling Half	link

BRAND	PART #	DESCRIPTION	LINK
Con-E-Co Aftermarket	1375387	1.125in Jaw Coupling Half	link

1375387



1100843



BRAND	PART #	DESCRIPTION	LINK
Con-E-Co Aftermarket	1100843	Coupling Spider	link

BRAND	PART #	DESCRIPTION	LINK
Con-E-Co Aftermarket	1104918	Plant Turnhead Side Liner	link

NO PIC

NO PIC

BRAND	PART #	DESCRIPTION	LINK
Con-E-Co Aftermarket	1104917	Plant Turnhead Bottom Liner	link

BRAND	PART #	DESCRIPTION	LINK
Con-E-Co Aftermarket	0145654	Turnhead Liner	link

NO PIC

190700



BRAND	PART #	DESCRIPTION	LINK
Con-E-Co Aftermarket	190700	Agg Bin 4 Position Turnhead Remote Transmitter and Receiver Assembly	link

BRAND	PART #	DESCRIPTION	LINK
Con-E-Co Aftermarket	700DK1	Agg Bin 8 Position Turnhead Remote Control and Transmitter	link

NO PIC

TURNHEADS

BRAND	PART #	DESCRIPTION	LINK
Erie Strayer	BP020848	1in Thick Weldable Urethane Turnhead Bottom Liner 89in Long	link

NO PIC

NO PIC

BRAND	PART #	DESCRIPTION	LINK
Erie Strayer	BP020847	1in Thick Weldable Urethane Turnhead Left Hand Side Liner 85.188in Long	link

BRAND	PART #	DESCRIPTION	LINK
Erie Strayer	BP020849	1in Thick Weldable Urethane Turnhead Right Hand Side Liner 85.188in Long	link

NO PIC

NO PIC

BRAND	PART #	DESCRIPTION	LINK
Johnson Ross	3313HRMUC3	Turnhead Hub with Hex Nuts	link

BRAND	PART #	DESCRIPTION	LINK
Johnson Ross	SP50642	Turnhead Spindle	link

NO PIC

NO PIC

BRAND	PART #	DESCRIPTION	LINK
Liddell	R02000631	Modified 36in 4-Position Rotary Turnhead Assembly	link

BRAND	PART #	DESCRIPTION	LINK
Liddell	900375001	Rotary Turnhead Spindle	link

NO PIC

NO PIC	BRAND	PART #	DESCRIPTION	LINK
	Liddell	900375002	Turnhead Hub with Hex Nuts	link

BRAND	PART #	DESCRIPTION	LINK	NO PIC
McNeilus	740145654	Aggregate Bin Turnhead Liner	link	



740117042

BRAND	PART #	DESCRIPTION	LINK
McNeilus	740117042	Aggregate Bin Turnhead Proximity Sensor	link

BRAND	PART #	DESCRIPTION	LINK	1100841
McNeilus	1100841	1.25in Jaw Coupling Half	link	



1100842

BRAND	PART #	DESCRIPTION	LINK
McNeilus	1100842	1.125in Jaw Coupling Half	link



BRAND	PART #	DESCRIPTION	LINK	NO PIC
McNeilus	1236952	3 Piece Turnhead Urethane Liner Kit	link	

PAGE
INTENTIONALLY
LEFT BLANK

2010



BRAND	PART #	DESCRIPTION	LINK
Stephens	2010	Magnehelic Gauge	link

MA014



BRAND	PART #	DESCRIPTION	LINK
C&W DustTech	MA014	Magnehelic Gauge	link

**PAGE
INTENTIONALLY
LEFT BLANK**

DUST COLLECTORS

NO PIC

BRAND	PART #	DESCRIPTION	LINK
Stephens	SV20	Dust Collector	link

BRAND	PART #	DESCRIPTION	LINK
Belgrade	DC225	Dust Collector-225 Square Feet of Bag Area	link



DC225

NO PIC

BRAND	PART #	DESCRIPTION	LINK
Belgrade	330PJDH	330 SqFt Pulse Jet Dust Collector	link

BRAND	PART #	DESCRIPTION	LINK
Belgrade	16FILVNT	16 SqFt Filter Vent	link

NO PIC

NO PIC

BRAND	PART #	DESCRIPTION	LINK
C&W DustTech	CP7500C480R	Single Compartment Dust Collector	link

BRAND	PART #	DESCRIPTION	LINK
Belgrade	CP2665S	Dust Collector	link

NO PIC



CP35S

BRAND	PART #	DESCRIPTION	LINK
C&W DustTech	CP35S	Weigh Batcher Dust Collector	link

DUST COLLECTORS

BRAND	PART #	DESCRIPTION	LINK
C&W DustTech	CP35FL3	Mounting Flange For CP35S Dust Collector	link

NO PIC

NO PIC

BRAND	PART #	DESCRIPTION	LINK
C&W DustTech	CP88SSHBSP	Dust Collector	link



MBV4

BRAND	PART #	DESCRIPTION	LINK
Con-E-Co Aftermarket	MBV4	Dust Collector with Filter Cartridges	link

NO PIC

BRAND	PART #	DESCRIPTION	LINK
Liddell	PJC305	Pulse Jet Silo Top Dust Collector	link

BRAND	PART #	DESCRIPTION	LINK
Liddell	R04000115	Dust Collector with Hopper Bottom	link

NO PIC



1140762

BRAND	PART #	DESCRIPTION	LINK
McNeilus	1140762	Jet Pulse Dust Collector for Cement Silos	link

DUST COLLECTORS

NO PIC

BRAND	PART #	DESCRIPTION	LINK
WAM	FNC1J03PH0Y	WAMFLO 400 Series Dust Collector	link

SILOTOPZERO7



BRAND	PART #	DESCRIPTION	LINK
WAM	SILOTOPZERO7	Dust Collector with Filter Cartridges	link

NO PIC

BRAND	PART #	DESCRIPTION	LINK
WAM	SILOTOPZERO7PDV	Dust Collector with Filter Cartridges and Pressure Switch	link

BRAND	PART #	DESCRIPTION	LINK
WAM	FNS2J12PP22A	WAMFLO Flanged Round Dust Collector	link

NO PIC

NO PIC

BRAND	PART #	DESCRIPTION	LINK
WAM	FNS4J36PV40	Antimoist 4KW WAMFLO	link

BRAND	PART #	DESCRIPTION	LINK
WAM	MK52PN	Blower Fan Motor Assembly	link

NO PIC

DUST COLLECTORS

WAM

BRAND	PART #	DESCRIPTION	LINK
WAM	VPACH	Fan Choke for Flanged Round Dust Collectors	link

NO PIC

NO PIC

BRAND	PART #	DESCRIPTION	LINK
WAM	VPADH	Fan Choke	link

UFN8001



BRAND	PART #	DESCRIPTION	LINK
WAM	UFN8001	Bottom Flange for Dust Collector	link

MCEFTS03NN00



BRAND	PART #	DESCRIPTION	LINK
WAM	MCEFTS03NN00	Silotop Dust Collector Electronic Board Control Box	link

BRAND	PART #	DESCRIPTION	LINK
WAM	MCEFCS03N0100	Silotop Dust Collector Electronic Board Control Box with Pressure Switch	link

NO PIC

NO PIC

BRAND	PART #	DESCRIPTION	LINK
WAM	MKC3	Dust Collector Rain Cap	link

BRAND	PART #	DESCRIPTION	LINK	
NO PIC	WAM	2099A9QMA	Plastic Venturi for Dust Collector	link

BRAND	PART #	DESCRIPTION	LINK
WAM	KEVN02450A	Electric Over Air Solenoid Valve	link



**PAGE
INTENTIONALLY
LEFT BLANK**

DUST BAGS

27201201



BRAND	PART #	DESCRIPTION	LINK
Stephens	27201201	Cement Batcher Vent Dust Collector Bag for SV20	link

BRAND	PART #	DESCRIPTION	LINK
-------	--------	-------------	------

Stephens 27200101 Silo Top Dust Collector Bag for SV170 and SV265 with Clamp Bottom NO PIC

27200901



BRAND	PART #	DESCRIPTION	LINK
Stephens	27200901	Silo Top Dust Collector Bag for SV170 and SV265 with Snap Band Bottom	link

BRAND	PART #	DESCRIPTION	LINK
-------	--------	-------------	------

Stephens 12050 Dust Bag J-Hook NO PIC



DS2

BRAND	PART #	DESCRIPTION	LINK
Belgrade	DS2	8in x 24in Dust Bag	link

BRAND	PART #	DESCRIPTION	LINK
-------	--------	-------------	------

Belgrade DS4 Plant Silo Dust Collector Bag 8 x 48 For Belgrade Dust House



DS4



DS6

BRAND	PART #	DESCRIPTION	LINK
Belgrade	DS6	8in Diameter x 72in Long Grommet Tuck and Taper Bag	link

DUST BAGS

BRAND	PART #	DESCRIPTION	LINK
-------	--------	-------------	------

Belgrade HC8 8in Plant Dust Bag Clamp [link](#) NO PIC



01999400011

BRAND	PART #	DESCRIPTION	LINK
-------	--------	-------------	------

Besser 01999400011 Metal Cap Top 5-Ring Snap-In Dust Collection Bag [link](#)

01999400010

BRAND	PART #	DESCRIPTION	LINK
-------	--------	-------------	------

Besser 01999400010 Dust Collection Bag S-Style Hanger Springs [link](#)



B0006

BRAND	PART #	DESCRIPTION	LINK
-------	--------	-------------	------

C&W DustTech B0006 5-7/8 x 120 Dust Collector Bag [link](#)

B0001

BRAND	PART #	DESCRIPTION	LINK
-------	--------	-------------	------

C&W DustTech B0001 Dust Collector Bag for RA and BP Collectors - 8 x 114 [link](#)



NO PIC

BRAND	PART #	DESCRIPTION	LINK
-------	--------	-------------	------

C&W DustTech B0011 8in x 138in Bags [link](#)

DUST BAGS

B0014



BRAND	PART #	DESCRIPTION	LINK
C&W DustTech	B0014	4in X 79in Dust Collector Filter Bag	link

BRAND	PART #	DESCRIPTION	LINK
C&W DustTech	B0117	Polyester Felt Bags	link

NO PIC

NO PIC

BRAND	PART #	DESCRIPTION	LINK
C&W DustTech	B0119	8in x 138in Bags	link

BRAND	PART #	DESCRIPTION	LINK
C&W DustTech	B0127	4in X 79in Dust Collector Filter Bag	link

B0127



147241



BRAND	PART #	DESCRIPTION	LINK
Con-E-Co Aftermarket	147241	Dust Vent Replacement Bags	link

BRAND	PART #	DESCRIPTION	LINK
Con-E-Co Aftermarket	0115017	Dust Collector Bag Hanger for SFV170 Filter Vents	link

0115017



1374898



BRAND	PART #	DESCRIPTION	LINK
Con-E-Co Aftermarket	1374898	Dust Collector Bag for BFV15 Batcher Vent	link

DUST BAGS

BRAND	PART #	DESCRIPTION	LINK
Con-E-Co Aftermarket	147236	Filter Bag	link

NO PIC

147247



BRAND	PART #	DESCRIPTION	LINK
Con-E-Co Aftermarket	147247	5-7/8 x 120 Dust Collector Bag	link

BRAND	PART #	DESCRIPTION	LINK
Con-E-Co Aftermarket	147235	Silo Dust Collector Bag Sock For SV30-250-3 Filter Vents 5 x 77	link

147235



BH0010



BRAND	PART #	DESCRIPTION	LINK
Con-E-Co Aftermarket	BH0010	Upper 5in Dia Bag Disk and Hardware Kit	link

BRAND	PART #	DESCRIPTION	LINK
Con-E-Co Aftermarket	1375467	Plant Dust Collector Bag for SFV170 Square Filter Vent 7"x70	link

1375467



1375468



BRAND	PART #	DESCRIPTION	LINK
Con-E-Co Aftermarket	1375468	Dust Collector Bag	link

DUST BAGS



1374910

BRAND	PART #	DESCRIPTION	LINK
Con-E-Co Aftermarket	1374910	Dust Collector Filter Bag	link

147240



BRAND	PART #	DESCRIPTION	LINK
Con-E-Co Aftermarket	147240	77in Long x 5in Dia Dust Filter Bag with Disc Top and Snap Band Bottom	link

NO PIC

BRAND	PART #	DESCRIPTION	LINK
Con-E-Co Aftermarket	147242	5 x 101 Dust Collector Bag for RA140 Central Collector	link

1374913



BRAND	PART #	DESCRIPTION	LINK
Con-E-Co Aftermarket	1374913	Concrete Plant Dust Bag- 4 7/8" X 106.5" for Model RA1500 and MS1500	link

900033005



BRAND	PART #	DESCRIPTION	LINK
Liddell	900033005	Dust Collector Bags	link

900033010



BRAND	PART #	DESCRIPTION	LINK
Liddell	900033010	Dust Collector Filter Bag	link

DUST BAGS

900033017



BRAND	PART #	DESCRIPTION	LINK
Liddell	900033017	Dust Collector Filter Bag	link

1375467



BRAND	PART #	DESCRIPTION	LINK
McNeilus	740115018705	Plant Dust Collector Bag for SFV170 Square Filter Vent 7"x70.5" with Snap Band	link

BRAND	PART #	DESCRIPTION	LINK
McNeilus	740115015	Dust Bag-SFV170 7" x 69.5"	link

NO PIC

740145815



BRAND	PART #	DESCRIPTION	LINK
McNeilus	740145815	Dust Collector Filter Bag	link

1237464

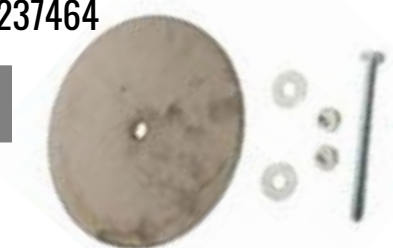

BRAND	PART #	DESCRIPTION	LINK
McNeilus	1237464	Upper 5in Dia Bag Disk & Hardware Kit	link

740145818



BRAND	PART #	DESCRIPTION	LINK
McNeilus	740145818	Concrete Plant Dust Bag- 4 7/8" X 106.5" for Model #RA1500 and MS1500	link

DUST BAGS

740100615	BRAND	PART #	DESCRIPTION	LINK
-----------	-------	--------	-------------	------



McNeilus	740100615	Dust Collector Eye Bolt	link
----------	-----------	-------------------------	----------------------

551043812061



BRAND	PART #	DESCRIPTION	LINK
-------	--------	-------------	------

Johnson Ross	551043812061	Filter Bag	link
--------------	--------------	------------	----------------------

NO PIC

BRAND	PART #	DESCRIPTION	LINK
-------	--------	-------------	------

Johnson Ross	5576982	Filter Bag	link
--------------	---------	------------	----------------------

BRAND	PART #	DESCRIPTION	LINK
-------	--------	-------------	------

Johnson Ross	5577359	Dust Collector Filter Bag for V100 - 8.25in X 43.5in	link
--------------	---------	--	----------------------

NO PIC



5576860

BRAND	PART #	DESCRIPTION	LINK
-------	--------	-------------	------

Johnson Ross	5576860	Dust Collector Filter Bag for V200 and V400 - 8.25in x 85in	link
--------------	---------	---	----------------------

BRAND	PART #	DESCRIPTION	LINK
-------	--------	-------------	------

Vince Hagan	082091	4in X 38.5in Dust Collector Filter Bag	link
-------------	--------	--	----------------------

082091



081524



BRAND	PART #	DESCRIPTION	LINK
-------	--------	-------------	------

Vince Hagan	081524	Central Dust Collector Bag	link
-------------	--------	----------------------------	----------------------

DUST BAGS

BRAND	PART #	DESCRIPTION	LINK
-------	--------	-------------	------

Vince Hagan	082383	8in x 65in Filter Bag	link
-------------	--------	-----------------------	----------------------

082383



NO PIC

BRAND	PART #	DESCRIPTION	LINK
-------	--------	-------------	------

Vince Hagan	082087	Open Loop Top Hanging Dust Bag 8in X 72in Snap Band	link
-------------	--------	---	----------------------



FILTER ORDER SHEET

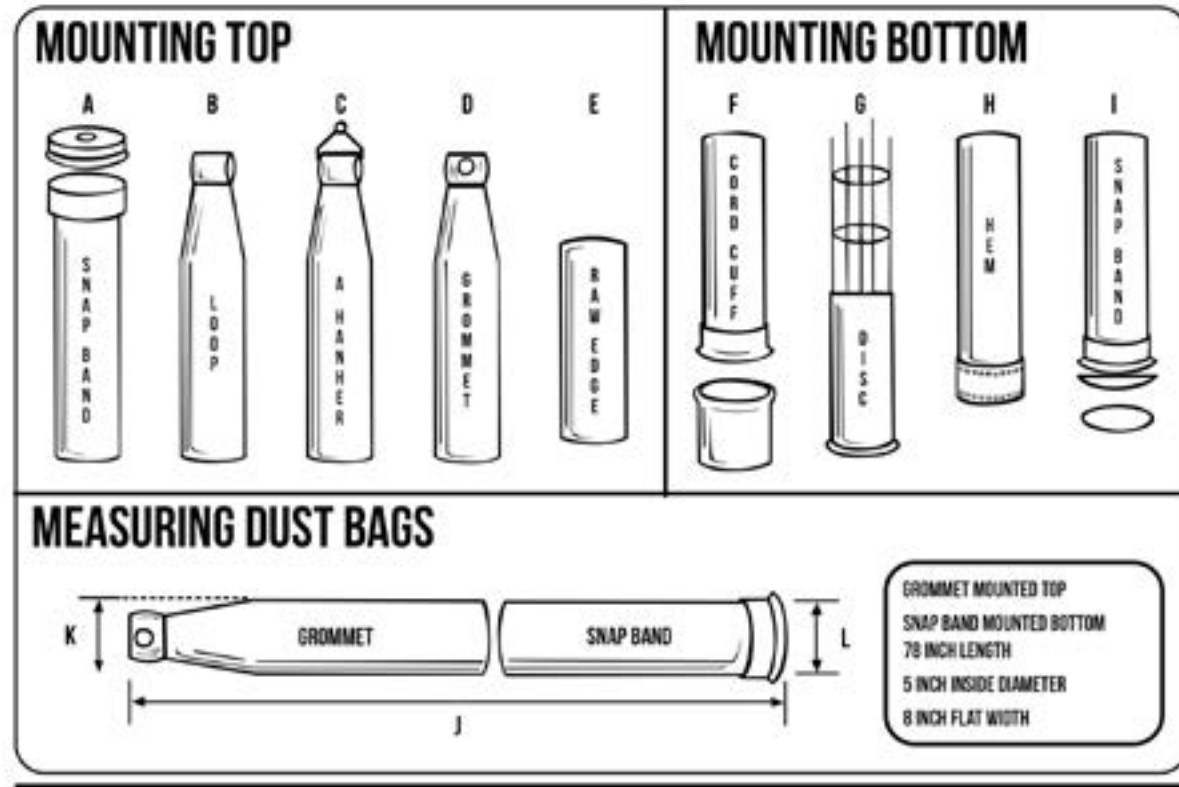

GROMMET MOUNTED TOP
SNAP BAND MOUNTED BOTTOM
78 INCH LENGTH
5 INCH INSIDE DIAMETER
8 INCH FLAT WIDTH

FILTER BAG IDENTIFICATION

MOUNTING TOP A B C D E MOUNTING BOTTOM F G H I

LENGTH (J) _____ DIAMETER (L) _____

FLAT WIDTH (K) _____ FABRIC (IF KNOWN) _____

WEIGHT (IF KNOWN) _____ FINISH (IF KNOWN) _____

MANUFACTURER, MAKE, AND MODEL OF BAGHOUSE _____

_____ QUANTITY _____

COMPANY INFORMATION

COMPANY _____ CONTACT _____

MAILING ADDRESS _____ CITY _____

STATE/ZIP _____ PHONE/FAX _____

**PAGE
INTENTIONALLY
LEFT BLANK**

FILTER CARTRIDGES

VENCAR1384X36



BRAND	PART #	DESCRIPTION	LINK
Stephens	VENCAR1384X36	13.84in x 36in x 9.479in Dust Collector Cartridge	link

BRAND	PART #	DESCRIPTION	LINK
Stephens	SOS6100	Cartridge Type Truck Dust Collector	link

NO PIC

BRAND	PART #	DESCRIPTION	LINK
Belgrade	C1030	Silo Top Dust Collector Filter Cartridge	link

NO PIC

BRAND	PART #	DESCRIPTION	LINK
Belgrade	DC1030	10in x 5.75in x 30in Filter Cartridge	link

DC1030



DC930



BRAND	PART #	DESCRIPTION	LINK
Belgrade	DC930	9in x 30in Filter Cartridge	link

CD000



BRAND	PART #	DESCRIPTION	LINK
C&W DustTech	CD000	Batcher Vent Dust Collector Filter Cartridge - 8x19	link

CD012



BRAND	PART #	DESCRIPTION	LINK
C&W DustTech	CD012	Dust Collector Filter Cartridge 8in x 39in	link

FILTER CARTRIDGES

BRAND	PART #	DESCRIPTION	LINK
C&W DustTech	CD007	Dust Collector Filter Cartridge 8 x 54	link

CD007



CD017

BRAND	PART #	DESCRIPTION	LINK
C&W DustTech	CD017	Dust Collector Filter Cartridge	link

BRAND	PART #	DESCRIPTION	LINK
C&W DustTech	CD011	Dust Collector Filter Cartridge	link

CD011



CD029



BRAND	PART #	DESCRIPTION	LINK
C&W DustTech	CD029	Filter Cartridge	link

CD122

BRAND	PART #	DESCRIPTION	LINK
C&W DustTech	CD122	Dust Collector Cartridge	link



NO PIC

BRAND	PART #	DESCRIPTION	LINK
C&W DustTech	CD124	8in X 78in X 103.4 with Aluminum Insert Dust Collector Cartridge	link

CD156

BRAND	PART #	DESCRIPTION	LINK
C&W DustTech	CD156	Filter Cartridge 7.9in x 78in	link



FILTER CARTRIDGES

1140645



BRAND	PART #	DESCRIPTION	LINK
Con-E-Co Aftermarket	1140645	Plant Cement Batcher MBV1 Jet Pulse Dust Collector Filter Cartridge	link

BRAND	PART #	DESCRIPTION	LINK
Con-E-Co Aftermarket	1237164	Dust Collector Filter Cartridge 8x78 for PJC Dust Collectors	link



1237164

1237165



BRAND	PART #	DESCRIPTION	LINK
Con-E-Co Aftermarket	1237165	Dust Collector Filter Cartridge 8 x 40	link

BRAND	PART #	DESCRIPTION	LINK
Con-E-Co Aftermarket	1140644	Dust Collector Filter Cartridge for MBV4 Dust Collector 12.75in x 27in	link

1140644

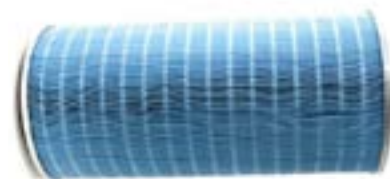

NO PIC

BRAND	PART #	DESCRIPTION	LINK
Con-E-Co Aftermarket	1100407	Cement Silo Dust Filter Cartridge-12.75 x 36	link

BRAND	PART #	DESCRIPTION	LINK
Johnson Ross	5576219	12.75in x 26in Dust Collector Filter Cartridge	link

5576219



FILTER CARTRIDGES

BRAND	PART #	DESCRIPTION	LINK
Johnson Ross	5576399	12.75in x 26in Dust Collector Cartridge Filter	link

NO PIC

900032002



BRAND	PART #	DESCRIPTION	LINK
Liddell	900032002	Dust Collector Filter Cartridge - 8in x 39in	link

BRAND	PART #	DESCRIPTION	LINK
Liddell	900032003	8in x 54in Dust Collector Filter Cartridge	link



900032003

NO PIC

BRAND	PART #	DESCRIPTION	LINK
Liddell	900032009	Polyester Filter Cartridge 26in X 12.75in X 8.38in	link

BRAND	PART #	DESCRIPTION	LINK
Liddell	900032010	Paper Filter Cartridge 26in X 12.75in X 8.38in	link

NO PIC

900032004



BRAND	PART #	DESCRIPTION	LINK
Liddell	900032004	Dust Collector Filter Cartridge	link

BRAND	PART #	DESCRIPTION	LINK
Liddell	900032011	Batcher Vent Dust Collector Filter Cartridge - 8in x 19in	link

900032011



FILTER CARTRIDGES



900032308

BRAND	PART #	DESCRIPTION	LINK
Liddell	900032308	Jet Pulse Cartridge Filter	link



081522

BRAND	PART #	DESCRIPTION	LINK
Vince Hagan	081522	8in X 36in Jet Pulse Cartridge Filter for VH-245JP Dust Collector	link

NO PIC

BRAND	PART #	DESCRIPTION	LINK
WAM	C032PHO	30in Spin Lock Style Dust Collector Filter Cartridge	link

BRAND	PART #	DESCRIPTION	LINK
WAM	C033PHO	36in Spin Lock Style Dust Collector Filter Cartridge	link

NO PIC

KFEW3007PHVE



x7

BRAND	PART #	DESCRIPTION	LINK
WAM	KFEW3007PHVE	Silotop ZERO Dust Collector Filter Cartridge Set of 7	link

BRAND	PART #	DESCRIPTION	LINK
WAM	C001PPB	Silo Top Dust Collector Filter Cartridge - 20in	link



C001PPB

FILTER CARTRIDGES



C002PPB

BRAND	PART #	DESCRIPTION	LINK
WAM	C002PPB	Silo Top Dust Collector Filter Cartridge - 30"	link



C003PPB

BRAND	PART #	DESCRIPTION	LINK
WAM	C003PPB	Silo Top Dust Collector Filter Cartridge - 36in	link

BRAND	PART #	DESCRIPTION	LINK
WAM	S002PPB	6in x 30in Pleated Screw-In Cartridges	link

NO PIC

NO PIC

BRAND	PART #	DESCRIPTION	LINK
WAM	S003PPB	Filter Cartridge for FS3J24 Dust Collectors	link

CONV002



BRAND	PART #	DESCRIPTION	LINK
Belgrade	CONV002	Concrete Plant Covered Charging Conveyor	link

CONV003



BRAND	PART #	DESCRIPTION	LINK
Belgrade	CONV003	Concrete Plant Charge Conveyors	link

**PAGE
INTENTIONALLY
LEFT BLANK**

SCREW CONVEYORS

	BRAND	PART #	DESCRIPTION	LINK
NO PICS	Liddell	SC9002	Screw Conveyor without Drive Package	link

BRAND	PART #	DESCRIPTION	LINK
Liddell	900003017	Screw Conveyor	link

NO PICS

	BRAND	PART #	DESCRIPTION	LINK
NO PICS	Liddell	900003126	10in Dlameter x 26.25ft Long Direct Drive Screw Conveyor	link

BRAND	PART #	DESCRIPTION	LINK
WAM	ES114050220	4in Cement Fly Ash Screw Conveyor with 3HP Motor 16.4ft Long	link

ES114050220



	BRAND	PART #	DESCRIPTION	LINK
NO PICS	WAM	ES114060220	4in Cement Fly Ash Screw Conveyor with 3HP Motor 16.4ft Long	link

BRAND	PART #	DESCRIPTION	LINK
WAM	ES114100400	4in Cement Fly Ash Screw Conveyor with 5HP Motor 32.81ft Long	link

NO PICS

	BRAND	PART #	DESCRIPTION	LINK
NO PICS	WAM	ES168030400	6in Cement Fly Ash Screw Conveyor with 5HP Motor 9.84ft Long	link

SCREW CONVEYORS

BRAND	PART #	DESCRIPTION	LINK
WAM	ES168040400	6in Cement Fly Ash Screw Conveyor with 5HP Motor 13.12ft Long	link

NO PICS

ES168050550	BRAND	PART #	DESCRIPTION	LINK
	WAM	ES168050550	6in Cement Fly Ash Screw Conveyor with 7.5HP Motor 16.40ft Long	link

BRAND	PART #	DESCRIPTION	LINK
WAM	ES168060550	6in Cement Fly Ash Screw Conveyor with 7.5HP Motor 19.69ft Long	link

NO PICS

	BRAND	PART #	DESCRIPTION	LINK
NO PICS	WAM	ES168070550	6in Cement Fly Ash Screw Conveyor with 7.5HP Motor 22.97ft Long	link

BRAND	PART #	DESCRIPTION	LINK
WAM	ES168080550	6in Cement Fly Ash Screw Conveyor with 7.5HP Motor 26.25ft Long	link

NO PICS

ES168090550	BRAND	PART #	DESCRIPTION	LINK
	WAM	ES168090550	6in Cement Fly Ash Screw Conveyor with 7.5HP Motor 29.53ft Long	link

BRAND	PART #	DESCRIPTION	LINK
WAM	ES168100750	6in Cement Fly Ash Screw Conveyor with 10HP Motor 32.81ft Long	link

NO PICS

SCREW CONVEYORS

NO PICS

BRAND	PART #	DESCRIPTION	LINK
WAM	ES168110750	6in Cement Fly Ash Screw Conveyor with 10HP Motor 36.09ft Long	link

BRAND	PART #	DESCRIPTION	LINK
WAM	ES168120750	6in Cement Fly Ash Screw Conveyor with 10HP Motor 39.37ft Long	link

NO PICS

NO PICS

BRAND	PART #	DESCRIPTION	LINK
WAM	ES168140750	6in Cement Fly Ash Screw Conveyor with 7.5HP Motor 45.93ft Long	link

BRAND	PART #	DESCRIPTION	LINK
WAM	ES168070400	6in Cement Fly Ash Screw Conveyor with 5HP Motor 22.97ft Long	link

NO PICS

NO PICS

BRAND	PART #	DESCRIPTION	LINK
WAM	ES168121100	6in Cement Fly Ash Screw Conveyor with 15HP Motor 39.37ft Long	link

BRAND	PART #	DESCRIPTION	LINK
WAM	ES16809AN	6in Cement Fly Ash Screw Conveyor with No Motor 29.53ft Long	link

NO PICS

NO PICS

BRAND	PART #	DESCRIPTION	LINK
WAM	ES219040750	8in Cement Fly Ash Screw Conveyor with 10HP Motor 13.12ft Long	link

SCREW CONVEYORS

NO PICS

BRAND	PART #	DESCRIPTION	LINK
WAM	ES219050750	8in Cement Fly Ash Screw Conveyor with 10HP Motor 16.40ft Long	link

NO PICS

NO PICS

BRAND	PART #	DESCRIPTION	LINK
WAM	ES219060750	8in Cement Fly Ash Screw Conveyor with 10HP Motor 19.69ft Long	link

ES219071100

BRAND	PART #	DESCRIPTION	LINK
WAM	ES219071100	8in Cement Fly Ash Screw Conveyor with 15HP Motor 22.97ft Long	link



NO PICS

BRAND	PART #	DESCRIPTION	LINK
WAM	ES219081100	8in Cement Fly Ash Screw Conveyor with 15HP Motor 26.25ft Long	link

BRAND	PART #	DESCRIPTION	LINK
WAM	ES219091100	8in Cement Fly Ash Screw Conveyor with 15HP Motor 29.53ft Long	link

NO PICS

NO PICS

BRAND	PART #	DESCRIPTION	LINK
WAM	ES219101500	8in Diameter x 10m Long Screw Conveyor with 20hp Motor	link

BRAND	PART #	DESCRIPTION	LINK
WAM	ES219111500	8in Cement Fly Ash Screw Conveyor with 20HP Motor 36.09ft Long	link

NO PICS

SCREW CONVEYORS

ES219131500



BRAND	PART #	DESCRIPTION	LINK
WAM	ES219131500	8in Cement Fly Ash Screw Conveyor with 20HP Motor 42.65ft Long	link

BRAND	PART #	DESCRIPTION	LINK
WAM	ES273030750	10in Cement Fly Ash Screw Conveyor with 10HP Motor 9.84ft Long	link

ES273030750



ES273030750



BRAND	PART #	DESCRIPTION	LINK
WAM	ES273040750	10in Cement Fly Ash Screw Conveyor with 10HP Motor 13.12ft Long	link

BRAND	PART #	DESCRIPTION	LINK
WAM	ES273051100	10in Cement Fly Ash Screw Conveyor with 15HP Motor 16.40ft Long	link

ES273051100



BRAND	PART #	DESCRIPTION	LINK	
NO PICS	WAM	ES273061100	10in Diameter x 6m Long Screw Conveyor with 15hp Motor	link

BRAND	PART #	DESCRIPTION	LINK
WAM	ES273071500	10in Cement Fly Ash Screw Conveyor with 20HP Motor 22.97ft Long	link

ES273071500



ES273081500



BRAND	PART #	DESCRIPTION	LINK
WAM	ES273081500	10in Cement Fly Ash Screw Conveyor with 20HP Motor 26.25ft Long	link

SCREW CONVEYORS

BRAND	PART #	DESCRIPTION	LINK
WAM	ES273091850	10in Cement Fly Ash Screw Conveyor with 25HP Motor 29.53ft Long	link

ES273091850



ES273101850



BRAND	PART #	DESCRIPTION	LINK
WAM	ES273101850	10in Cement Fly Ash Screw Conveyor with 25HP Motor 32.81ft Long	link

BRAND	PART #	DESCRIPTION	LINK
WAM	ES273121850	10in Cement Fly Ash Screw Conveyor with 25HP Motor 39.37ft Long	link

NO PICS

NO PICS

BRAND	PART #	DESCRIPTION	LINK
WAM	ES273132200	10in Diameter x 13m Long Screw Conveyor with 30hp Motor	link

BRAND	PART #	DESCRIPTION	LINK
WAM	ES219111100	8in Cement Fly Ash Screw Conveyor with 15HP Motor 36.09ft Long	link

NO PICS

NO PICS

BRAND	PART #	DESCRIPTION	LINK
WAM	ES219101100	8in Cement Fly Ash Screw Conveyor with 15HP Motor 32.81ft Long	link

BRAND	PART #	DESCRIPTION	LINK
WAM	20993801A	Outlet Flighting ES/TU D.219	link

NO PICS

SCREW CONVEYORS

BRAND	PART #	DESCRIPTION	LINK
NO PICS	WAM	ES21906AN 8in Cement Fly Ash Screw Conveyor with No Motor 19.69ft Long	link
BRAND	PART #	DESCRIPTION	LINK
WAM	ES273081850	10in Cement Fly Ash Screw Conveyor with 25HP Motor 26.25ft Long	link
NO PICS	WAM	ES273061500 10in Cement Fly Ash Screw Conveyor with 20HP Motor 19.69ft Long	link
BRAND	PART #	DESCRIPTION	LINK
WAM	ES27309AN	10in Cement Fly Ash Screw Conveyor with No Motor 29.53ft Long	link
NO PICS	WAM	ES27308AN 10in Cement Fly Ash Screw Conveyor with No Motor 26.25ft Long	link
BRAND	PART #	DESCRIPTION	LINK
WAM	ES27311AN	10in Cement Fly Ash Screw Conveyor with No Motor 36.09ft Long	link
NO PICS	WAM	ES27307AN 10in Cement Fly Ash Screw Conveyor with No Motor 22.97ft Long	link

SCREW CONVEYORS

BRAND	PART #	DESCRIPTION	LINK
WAM	ES273141500	10in Cement Fly Ash Screw Conveyor with 20HP Motor 45.93ft Long	link
NO PICS	WAM	ES273041100 10in Cement Fly Ash Screw Conveyor with 15HP Motor 13.12ft Long	link
BRAND	PART #	DESCRIPTION	LINK
WAM	ES27304AN	10in Cement Fly Ash Screw Conveyor with No Motor 13.12ft Long	link
NO PICS	WAM	ES273050750 10in Cement Fly Ash Screw Conveyor with 10HP Motor 16.40ft Long	link
BRAND	PART #	DESCRIPTION	LINK
WAM	ES273131850	10in Cement Fly Ash Screw Conveyor with 25HP Motor 42.65ft Long	link
NO PICS	WAM	ES273111500 10in Cement Fly Ash Screw Conveyor with 20HP Motor 36.09ft Long	link
BRAND	PART #	DESCRIPTION	LINK
WAM	ES273122200	10in Cement Fly Ash Screw Conveyor with 30HP Motor 39.37ft Long	link

SCREW CONVEYORS

	BRAND	PART #	DESCRIPTION	LINK
NO PICS	WAM	ES27312AN	10in Cement Fly Ash Screw Conveyor with No Motor 39.37ft Long	link

BRAND	PART #	DESCRIPTION	LINK	ES323031100
WAM	ES323031100	12in Cement Fly Ash Screw Conveyor with 15HP Motor 9.84ft Long	link	

	BRAND	PART #	DESCRIPTION	LINK
NO PICS	WAM	ES323041500	12in Cement Fly Ash Screw Conveyor with 20HP Motor 13.12ft Long	link

BRAND	PART #	DESCRIPTION	LINK	ES323051850
WAM	ES323051850	12in Cement Fly Ash Screw Conveyor with 25HP Motor 16.40ft Long	link	

ES323072200	BRAND	PART #	DESCRIPTION	LINK
	WAM	ES323072200	12in Cement Fly Ash Screw Conveyor with 30HP Motor 22.97ft Long	link

BRAND	PART #	DESCRIPTION	LINK	ES323082200
WAM	ES323082200	12in Cement Fly Ash Screw Conveyor with 30HP Motor 26.25ft Long	link	

	BRAND	PART #	DESCRIPTION	LINK
NO PICS	WAM	ES323093000	12in Cement Fly Ash Screw Conveyor with 40HP Motor 29.53ft Long	link

SCREW CONVEYORS

BRAND	PART #	DESCRIPTION	LINK	
WAM	ES323103000	12in Cement Fly Ash Screw Conveyor with 40HP Motor 29.53ft Long	link	NO PICS

	BRAND	PART #	DESCRIPTION	LINK
NO PICS	WAM	ES323113000	12in Cement Fly Ash Screw Conveyor with 40HP Motor 36.09ft Long	link

BRAND	PART #	DESCRIPTION	LINK	
WAM	ES32309AN	12in Cement Fly Ash Screw Conveyor with No Motor 29.53ft Long	link	NO PICS

	BRAND	PART #	DESCRIPTION	LINK
NO PICS	WAM	ES32305AN	12in Cement Fly Ash Screw Conveyor with No Motor 16.40ft Long	link

BRAND	PART #	DESCRIPTION	LINK	
WAM	ES323051100	12in Cement Fly Ash Screw Conveyor with 15HP Motor 16.40ft Long	link	NO PICS

	BRAND	PART #	DESCRIPTION	LINK
NO PICS	WAM	ES323091850	12in Cement Fly Ash Screw Conveyor with 25HP Motor 29.53ft Long	link

BRAND	PART #	DESCRIPTION	LINK	
WAM	ES323073000	12in Cement Fly Ash Screw Conveyor with 40HP Motor 22.97ft Long	link	NO PICS

	BRAND	PART #	DESCRIPTION	LINK
NO PICS	WAM	ES323071850	12in Cement Fly Ash Screw Conveyor with 25HP Motor 22.97ft Long	link

	BRAND	PART #	DESCRIPTION	LINK	
	WAM	ES323101850	12in Cement Fly Ash Screw Conveyor with 25HP Motor 32.81ft Long	link	NO PICS

**PAGE
INTENTIONALLY
LEFT BLANK**